

Catálogo

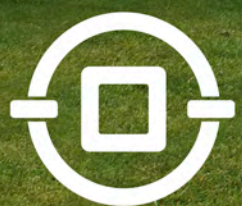

Perfiletto®

INNOVATION ALUMINUM

www.perfiletto.com

849 Perfiles



LOS COLORES MOSTRADOS PUEDEN VARIAR LIGERAMENTE DEL COLOR ORIGINAL

ANODIZADO

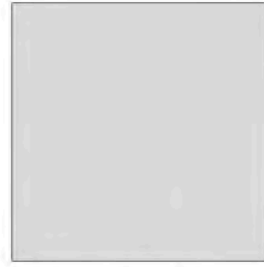

Natural Mate



Champagne

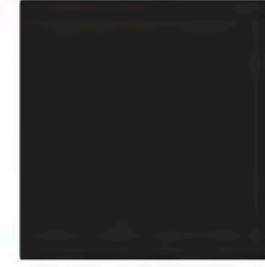

Electro

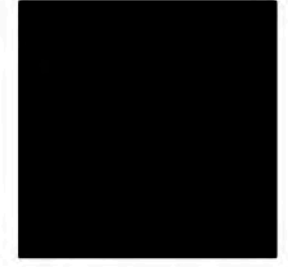

Negro Mate

PINTURA ELECTROSTÁTICA

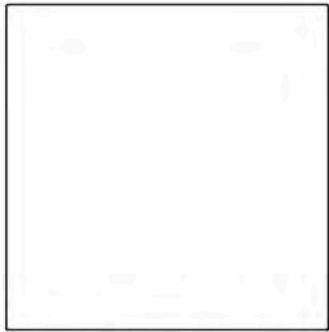

Blanco

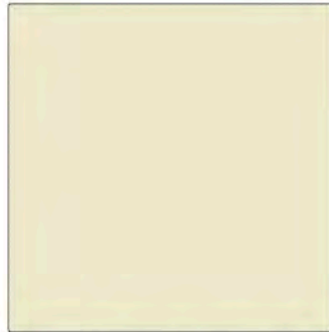

Hueso Liso



Champagne



Café Adobe



Duro Europa



Negro



Gris Europa



Café Chocolate



Café Bronce



Verde 7033

Nombre:

Empresa:

Email:

Distribuidor:

Contacto:

Email:

ESPECIFICACIONES TÉCNICAS DEL PERFIL DE ALUMINIO

ALEACIÓN 6063 (Al - Si - Mg)

La cual contiene entre 98 % y 99 % de aluminio y el resto de otros metales. Esta Aleación es utilizada en Líneas Arquitectónicas, por ser la adecuada para el proceso del anodizado.

Perfiletto ALUMINUM	Silicio (Si)	Hierro (Fe)	Cobre (Cu)	Manganeso (Mn)	Magnesio (Mg)	Cromo (Cr)	Zinc (Zn)	Titanio (Ti)	Otros	Aluminio (Al)
Mínimo	0.20	-----	-----	-----	0.45	-----	-----	-----	-----	Resto
Máximo	0.60	0.35	0.10	0.10	0.90	0.10	0.10	0.10	0.15	Resto

* Pruebas realizadas en equipo Spectromax X para control de calidad.

CARACTERÍSTICAS DEL ALUMINIO

Resistencia a Vientos:	Variables según nuestras líneas y espesor de cristal
Reciclable:	Sí
Conductor Térmico:	53 CAL. GR. x Segundo x cm ²
Resistencia Eléctrica:	0.028264 ohm-mm ² /m A 20° C

TEMPLE T5

T - La letra T indica que el metal ha sido sometido a tratamiento térmico. - El número final indica el tipo de tratamiento térmico

El proceso de Temple consta de dos fases, la primera tiene como objetivo, mejorar la dureza y la flexibilidad del metal, modificando su estructura interna por medio de un tratamiento térmico y la segunda consiste en someterlo a una temperatura de 190° C x 5 hrs, permitiendo que el metal conserve sus características requeridas para el aluminio arquitectónico.

Dureza :	8 - 12° Webster
Cedencia mínima:	16000 lbs/in ²
Resistencia última:	22000 lbs/in ²
Módulo elasticidad:	10000 lbs/in ²
Fatiga:	10000 lbs/in ²



ACABADOS

Anodizado

El Anodizado es un Proceso Electrolítico de Oxidación forzada, en el cual, se logra formar una capa de Óxido de Aluminio, sobre la superficie del metal. Se pueden lograr diferentes colores en su proceso. Un buen anodizado debe tener dos características primordiales: Micraje y Tono Adecuado.

El Micraje en Perfiles Perfiletto es entre 12 y 16 Micras. Nuestros Anodizados pasan por un control de calidad de tonos. No se considera como capa protectora abajo de 5 micras.

Equipo: Medidor de Recubrimientos POSITECTOR 6000

Pintura Electrostática

Se realiza un proceso de pre-tratamiento de la superficie abriendo poros en el aluminio, para después aplicar la pintura en polvo Serie 38 Super Durable, logrando una Alta Resistencia a los rayos UV, la cual se funde sobre la superficie mediante el proceso de horneado garantizando una buena adherencia de la pintura al perfil.

El Micraje en el Proceso de Pintura Electrostática es variable entre 80 y 100 Micras

Sublimados Madera

Es un efecto que se le da al aluminio mediante el cual, en la primera parte del proceso utilizamos materias primas de excelente calidad con Base Poliuretana Clase 3 Super Durable con tecnología de punta y en la segunda del mismo, se realiza con Tintas Termotransferibles de Base Poliéster, logrando así el acabado madera, conservando intactas las vetas y nudos en el Perfil.

El Micraje en el Proceso de Sublimado Madera es variable entre 70 - 90 micras

PRUEBAS CONTROL DE CALIDAD

Cámara de Corrosión Salina

Bajo la norma ASTM B117, la cual dice que cada 1000 hrs. de exposición son equivalentes a 10 años expuestos en un ambiente salino similar al de las costas y playas.

En Perfiletto Aluminum nuestras muestras son sometidas a pruebas más agresivas que las que indica la Norma, en ciclos de 3000 hrs. que equivalen en promedio de 20 a 30 años.

Equipo: (Q - FCG Cyclic Corrosión Tester)

Resistencia a la Radiación Ultravioleta

Bajo la Norma ASTM G154 Ciclo 1, con exposición continua de 800 hrs. con una equivalencia aproximada a 3 años expuesto a la intemperie en lugares extremos.

Nuestras pruebas son sometidas a 2400 hrs. con una equivalencia aproximada de 8 años, 10 meses y 7 días sin tener alteraciones considerables en brillo y color.

Esto lo podemos verificar mediante:

Equipo QUV Accelerated Weathering Tester Mod. QV/Spray con Lámparas UVA340.

NORMAS Y PRUEBAS DE CALIDAD

Medidor de Espesores: Positector 6000	Norma: ASTM D - 186
Medidor de Adherencia: Uña de Gato	Norma: ASTM - 3359
Medidor de Adherencia Destructiva	Elcometer
Laboratorio para la Prueba de Impacto	Norma: ASTM 2794 (De 100 a 160 lbs/in2)

QUV (Tipo Lámpara UVA340) Norma: ASTM G-154

Paso 1: 8 horas Radiación UV a 60° C
Paso 2: 4 horas Condensación a 50° C

Horas QUV	Equivalencia Aproximada
100	4 meses 15 días
200	9 meses
300	1 año 1 mes 15 días
400	1 año 6 meses
500	1 año 10 meses 15 días
600	2 años 3 meses
700	2 años 7 meses 15 días
800	3 años
900	3 años 4 meses 15 días
1000	3 años 9 meses
2000	7 años 6 meses
3000	11 años 3 meses
4000	15 años
5000	18 años 9 meses
6000	22 años 6 meses
7000	26 años 6 meses
8000	30 años

FILM PROTECTOR

Nuestros perfiles vienen con film protector y a su vez empacados en un plástico termoendurecible para evitar daños durante su manejo, almacenaje y entrega.

ÍNDICE LÍNEAS ARQUITECTÓNICAS

LÍNEA U -LIGHT / C-LIGHT

- 1 FIJO - VENTANA Y PUERTA CORREDIZA
VENTANA DE GUILLOTINA
- 2 U-LIGHT VENTANA Y PUERTA CORREDIZA
- 3 C-LIGHT VENTANA Y PUERTA CORREDIZA
- 4 PUERTA BATIENTE

LÍNEA 2"

- 5 ECONÓMICA HERMÉTICA - VENTANA Y PUERTA CORREDIZA
- 7 PUERTA BATIENTE
- 8 LIGHT FIJO
- 9 LIGHT HERMÉTICA - VENTANA Y PUERTA CORREDIZA
- 12 PUERTA BATIENTE SAN LUIS
- 15 COMERCIAL FIJO
- 16 COMERCIAL HERMÉTICA - VENTANA Y PUERTA CORREDIZA
- 20 LÍNEA ESCOLAR
- 22 VENTANA DE GUILLOTINA
- 23 SIFÓN
- 24 VENTANA BATIENTE "o" PROYECCIÓN
- 26 BATIENTES PUERTA MULTIPANEL
- 27 PUERTA BATIENTE COMERCIAL

LÍNEA 3"

- 28 ECONÓMICA HERMÉTICA - VENTANA Y PUERTA CORREDIZA
- 30 LIGHT FIJO
- 31 LIGHT HERMÉTICA - VENTANA Y PUERTA CORREDIZA
- 33 COMERCIAL FIJO
- 35 COMERCIAL HERMÉTICA - VENTANA Y PUERTA CORREDIZA
- 45 HERMÉTICA PLUS - VENTANA Y PUERTA CORREDIZA
- 47 FIJO CRISTAL DOBLE
- 49 CRISTAL DOBLE - VENTANA Y PUERTA CORREDIZA
- 51 VENTANA BATIENTE "o" PROYECCIÓN
- 53 VENTANA DE GUILLOTINA
- 54 SIFÓN
- 55 SIFÓN CRISTAL DOBLE
- 62 BATIENTES

56 PUERTA BATIENTE MULTI-DISEÑOS

SERIE 70

- 64 FIJO - VENTANA Y PUERTA CORREDIZA
- 69 TRIPLE / FIJO - VENTANA Y PUERTA CORREDIZA
- 73 CRISTAL DOBLE / FIJO - VENTANA Y PUERTA CORREDIZA
- 77 VENTANA BATIENTE "o" PROYECCIÓN
- 78 BATIENTES

SERIE 80

- 79 FIJO
- 80 VENTANA Y PUERTA CORREDIZA VINIL RESPALDO
- 83 VENTANA Y PUERTA CORREDIZA VINIL CUÑA
- 84 TRIPLE FIJO - VENTANA Y PUERTA CORREDIZA
- 87 FIJO CRISTAL DOBLE RIEL DOBLE
- 88 FIJO CRISTAL DOBLE RIEL TRIPLE
- 89 CRISTAL DOBLE VENTANA Y PUERTA CORREDIZA
- 90 BATIENTES

SERIE 100

- 91 FIJO
- 92 HERMÉTICA - VENTANA Y PUERTA CORREDIZA
- 98 HERMÉTICA CRISTAL DOBLE
- 102 FIJO TRIPLE
- 104 HERMÉTICA TRIPLE
- 108 VENTANA BATIENTE "o" PROYECCIÓN
- 109 BATIENTES

114 PUERTA BATIENTE TOSCANA

116 PUERTA MONUMENTAL

SERIE 35

- 118 FIJO - VENTANA BATIENTE "O" PROYECCIÓN
- 123 CRISTAL DOBLE

SERIE 50

- 124 FIJO - VENTANA BATIENTE "O" PROYECCIÓN
- 124 CRISTAL DOBLE
- 124 FIJO - VENTANA BATIENTE "O" PROYECCIÓN
- 124 BATIENTES

127 LÍNEA FIJA, PROYECCIÓN Y ABATIBLE 1400

MOSQUITEROS ENROLLABLES

- 129 BÁSICO GUILLOTINA CON CADENA
- 129 BÁSICO CORREDIZO
- 130 REFORZADO GUILLOTINA CON CADENA
- 130 REFORZADO CORREDIZO

131 CELOSIA FIJA

132 ROMPE VISTA

DUELAS

- 134 DOBLE VISTA
- 135 UNA VISTA
- 136 COMBINABLES

137 PASAMANOS

ZOCLOS ESPECIALES

- 139 HERCULITE
- 140 MURO

140 SARDINELES

CANCELES DE BAÑO

- 141 CORREDIZO
- 142 MAYOR VISTA
- 142 BATIENTES
- 143 TEMPLADO

FACHADA INTEGRAL

- 144 BÁSICO CERRADO
- 145 BÁSICO ABIERTO

TUBOS CUADRADOS

- 147 COMERCIALES
- 147 LIGHT

148 ROMPE VISTAS CUADRICULADAS

148 TUBOS REDONDOS

TUBOS RECTANGULARES

- 149 COMERCIALES
- 150 LIGHT

VIGAS

- 151 RECTANGULAR
- 153 RECTANGULAR COLONIAL

154 PERFILES PARA DOMO

155 ÁNGULOS

155 SOLERAS

156 CRUCETA

156 TEES

156 VITRINAS

156 PORTA CRISTAL

156 VAGUETAS

157 LÍNEA PIZARRÓN

157 RIELES

157 GUARDAPOLVOS

157 RIBETES

158 SISTEMA PLEGADIZO

159 RESISTENCIAS A VIENTOS / TABLAS DE CORTE

ÍNDICE DE PERFILES POR CLAVE

CLAVE	PAG.	CLAVE	PAG.	CLAVE	PAG.	CLAVE	PAG.	CLAVE	PAG.	CLAVE	PAG.	CLAVE	PAG.	CLAVE	PAG.	CLAVE	PAG.
1120	6	2532	148	6055	131	7824	16	8522	135	9131	29	10021	142	12506	123	13614	90
1120	10	2533	148	6072	131	7825	16	8523	135	9132	61	10022	142	12507	72	13615	83
1120	19	3150	156	6082	131	7826	40	8524	135	9133	61	10098	133	12507	86	13615	90
1123	35	3160	156	6370	26	7828	156	8550	26	9134	61	10099	133	12507	123	13616	83
1199	15	3165	156	6371	26	7832	34	8556	26	9135	32	10197	141	12509	123	13616	90
1199	32	3184	156	6533	18	7833	34	8562	1	9136	32	10198	141	12522	149	13617	83
1200	46	3185	156	6533	38	7835	34	8562	22	9137	33	10201	142	12523	151	13617	90
1201	154	3186	156	6534	17	7836	34	8563	1	9138	33	10220	39	12524	150	13630	97
1202	154	3188	155	6601	69	7837	4	8563	22	9139	32	10235	33	12525	151	13636	155
1203	154	3229	156	6601	73	7837	7	8563	52	9183	56	10237	32	12526	150	13637	95
1204	154	3230	156	6602	69	7837	36	8564	52	9187	56	10265	28	12527	151	13640	97
1205	154	3311	155	6602	73	7838	4	8565	52	9204	55	10266	32	12528	152	13646	57
1207	154	3312	156	6605	68	7838	7	8570	26	9207	56	10465	53	12529	151	13829	87
1208	4	3316	155	6605	69	7839	4	8586	15	9231	156	10466	53	12530	111	13829	96
1208	7	3329	155	6606	69	7839	7	8591	15	9236	4	10467	53	12531	112	13830	87
1211	154	3358	155	6607	69	7840	37	8670	1	9236	7	10469	53	12537	12	13830	96
1214	149	4040	57	6608	69	7842	37	8671	22	9242	89	10697	54	12537	12	13830	96
1215	149	4042	139	6609	69	7843	35	8671	22	9242	108	11003	143	12538	63	13831	87
1216	154	4043	139	6610	73	7843	35	8681	35	9242	109	11004	143	12538	78	13831	96
1217	154	4044	58	6611	73	7844	35	8681	45	9243	109	11035	141	12538	102	13831	96
1228	154	4045	113	6611	73	7845	37	8800	140	9244	61	11036	141	12543	51	13832	87
1258	154	4046	114	6612	73	7847	35	8801	140	9245	89	11037	3	12543	59	13832	96
1301	154	4047	58	6613	73	7848	35	8802	141	9246	89	11041	2	12543	123	13842	64
1303	154	4048	58	6617	134	7851	39	8936	25	9246	108	11041	3	12543	125	13842	79
1304	154	4049	57	6775	135	7851	80	8937	25	9247	20	11043	3	12563	123	14100	133
1311	154	4049	131	6854	141	7852	66	9069	141	9247	60	11044	16	12580	154	14109	83
1314	154	4050	23	7009	26	7862	40	9072	1	9248	20	11047	3	12590	154	14109	90
1315	154	4051	8	7010	60	7973	21	9073	1	9249	60	11048	2	12591	111	14110	83
1318	154	4051	15	7013	155	8243	109	9073	1	9255	4	11048	3	12591	154	14110	90
1420	154	4053	132	7014	155	8264	13	9074	1	9256	7	11068	3	12592	123	14320	115
1426	155	4079	140	7071	68	8264	39	9075	1	9272	41	11096	2	12593	123	14321	116
1432	155	4100	134	7101	18	8264	57	9076	1	9274	40	11130	134	12594	123	14322	23
1609	155	4112	140	7101	38	8265	39	9077	23	9351	153	11203	16	12594	123	14322	57
1611	155	4127	141	7102	141	8266	64	9078	1	9353	153	11408	75	12601	60	14322	57
2105	147	4200	140	7265	39	8266	79	9078	4	9354	153	11410	75	12604	51	14323	51
2108	147	4300	140	7315	32	8266	64	9079	23	9355	153	11411	75	12604	60	14323	59
2111	147	4331	140	7316	32	8267	39	9080	23	9356	1	11412	75	12604	125	14323	125
2317	155	4332	140	7333	18	8267	64	9081	23	9357	153	11412	75	12605	121	14325	56
2318	155	4334	140	7336	3	8267	79	9082	23	9366	137	11559	136	12606	121	14325	56
2318	155	4337	140	7336	11	8268	64	9083	36	9756	141	11560	136	12606	121	14349	145
2351	146	4400	140	7336	11	8268	79	9084	15	9900	42	11561	137	12608	121	14350	145
2354	146	5019	139	7336	18	8269	39	9084	15	9900	42	11599	130	12609	121	14351	145
2356	146	5080	156	7518	19	8270	19	9085	15	9901	42	11599	130	12610	122	14352	145
2358	146	5081	157	7525	17	8271	39	9086	8	9903	42	11672	135	12610	122	14352	145
2359	146	5081	157	7740	20	8272	13	9088	15	9904	42	11763	2	12613	122	14384	83
2361	114	5115	26	7741	20	8272	39	9088	15	9904	43	11763	22	12614	122	14384	87
2361	146	5117	62	7748	20	8272	13	9088	23	9947	141	11763	52	12617	123	14384	90
2361	146	5117	110	7792	8	8272	57	9089	15	9953	19	11945	137	12618	77	14384	96
2362	146	5370	59	7792	8	8300	138	9090	15	9954	17	11946	137	12618	89	14384	96
2363	146	5565	156	7792	15	8320	17	9091	15	9954	17	12270	120	12619	77	14385	83
2364	146	5566	156	7792	20	8324	139	9105	24	9955	17	12273	120	12619	77	14385	90
2502	148	5567	116	7793	6	8325	139	9111	33	9957	40	12274	120	12623	122	14386	110
2503	148	5567	156	7793	7	8326	138	9111	25	9958	48	12275	120	12653	57	14386	110
2504	140	5686	155	7793	8	8327	138	9111	53	9959	48	12276	120	12654	57	14389	144
2513	148	5844	26	7815	16	8327	138	9112	32	9960	48	12276	120	12664	74	14698	145
2515	148	6050	130	7816	18	8328	138	9112	32	9961	48	12362	147	12694	121	14739	143
2516	148	6051	130	7817	18	8329	138	9114	53	9962	48	12363	147	12756	123	14918	39
2520	148	6052	130	7818	156	8370	19	9114	32	9963	48	12393	48	12757	77	15043	48
2521	148	6053	130	7819	19	8371	19	9115	32	9964	49	12394	39	12757	89	15173	24
2522	148	6054	131	7821	17	8519	115	9116	33	9965	49	12395	39	12796	121	15173	120
				7823	19	8520	135	9117	61	10004	133	12437	74	13396	107	15230	94
						8521	135	9129	62	10020	142	12503	123	13609	122	15231	94
								9130	50			12504	123	13614	83	15232	95

ÍNDICE DE PERFILES POR CLAVE

CLAVE	PAG.	CLAVE	PAG.	CLAVE	PAG.	CLAVE	PAG.	CLAVE	PAG.	CLAVE	PAG.	CLAVE	PAG.	CLAVE	PAG.
15236	94	22270	121	23617	101	28409	66	38420	88	62370	68	68591	8	79953	5
15309	2	22271	25	23618	102	28410	65	39188	116	62371	68	68792	98	79954	6
15310	2	22271	121	23630	102	28411	65	41400	126	62372	68	68802	140	79955	6
15311	2	22273	120	23639	105	28412	65	41401	126	62374	70	68802	141	79957	27
15312	2	22274	120	23642	106	28419	74	41402	126	62375	68	69082	36	81642	19
15314	2	22276	120	23843	74	28420	74	41405	127	62375	69	69083	8	81642	39
15407	81	22277	119	23843	88	28421	74	41406	127	62375	73	69084	8	81642	57
15408	81	22503	63	23896	136	28422	74	41407	127	62377	70	69085	8	82516	132
16370	1	22503	72	24055	69	28591	14	41423	127	62378	70	69088	8	82521	132
16533	18	22503	78	24055	73	29086	15	41430	126	62379	71	69091	24	83581	97
16533	38	22503	86	24084	99	29188	116	41431	126	62380	74	69112	29	83638	105
16534	17	22504	63	24085	99	29243	116	41433	126	62472	144	69135	29	84581	91
16534	38	22504	78	24113	72	30001	129	41434	127	62513	149	69136	29	85844	21
16616	133	22537	55	24113	86	32263	82	42263	82	62515	149	69183	26	86370	12
16617	133	22538	55	24323	51	32273	120	42273	117	62516	149	69187	26	86372	12
17821	17	22547	64	24323	59	32274	24	42274	119	62520	149	69204	26	86617	115
17826	44	22576	51	24323	125	32274	118	42275	119	62521	149	69207	26	86617	134
17835	44	22576	59	24324	51	32276	119	42276	119	62522	149	69244	61	89187	13
17840	37	22576	125	24324	59	32437	88	42507	63	63184	156	69246	89	93580	92
17842	44	22592	72	24324	125	32505	63	44426	93	64052	10	69246	108	93582	92
17847	35	22592	86	24325	59	32505	78	44427	93	64052	17	69953	9	93638	106
17847	45	22593	72	24326	59	32506	63	45844	14	64083	98	69954	10	93643	95
17848	35	22593	86	24327	51	32506	78	46370	1	64100	135	69955	10	94082	100
17848	45	22594	72	24327	59	32508	63	46370	51	64112	19	72376	70	94083	100
18413	75	22594	86	24327	125	32508	78	46370	59	64112	19	72376	84	94409	91
18930	75	22601	60	24328	51	32563	63	46370	125	65844	26	72376	84	94410	91
19076	4	22603	51	24328	59	32563	78	46534	38	66054	131	72516	132	94581	91
19187	56	22603	122	24328	125	32563	86	46534	75	66055	131	72521	132	95844	25
19188	13	22603	125	24330	51	32576	51	46901	55	66370	26	74052	6	96370	60
19188	57	22604	60	24330	59	32576	59	47862	41	66533	11	74083	98	96617	115
19242	89	22619	77	24330	110	32576	125	48408	80	66534	10	74396	76	96617	134
19242	108	22620	63	24330	125	33635	103	48409	80	66617	135	74581	91	98792	100
19243	109	22620	78	24331	51	33637	95	48416	85	67315	29	75844	21	412540	55
19955	17	22621	63	24331	59	33638	98	48591	14	67317	31	76370	51	412542	55
19957	44	22621	78	24331	125	33640	106	49074	1	67317	35	76370	59	412543	51
19959	48	22695	63	24350	145	34082	97	49188	13	67333	18	76370	125	412543	59
19959	48	22695	78	24410	97	34323	60	49188	26	67518	11	76371	12	412543	125
19963	49	22757	14	25173	50	34397	124	49188	57	67523	9	76372	12	412544	55
19964	49	22757	77	25173	76	34715	103	49189	57	67525	10	76533	5	412545	55
20001	128	22757	89	25173	107	34716	104	52273	120	67818	19	76534	6	412550	55
20003	129	23573	95	25173	124	34717	104	52274	24	67819	11	76617	115	412576	51
20007	128	23574	83	25230	94	34718	104	53639	106	67821	10	76617	134	412576	59
20008	128	23575	105	25231	94	34719	104	54082	97	67824	10	77317	28	412576	125
20009	128	23576	105	25313	2	35844	26	54395	50	67825	10	77518	6	412596	56
20010	128	23577	83	25407	81	36533	41	54395	76	67826	31	77523	5	412597	56
20011	129	23577	87	26533	18	38182	46	54395	107	67828	41	77824	6	412599	56
20012	129	23577	90	26533	38	38183	46	54396	124	67847	31	77825	6	412602	56
20080	63	23577	96	26534	17	38184	46	55844	14	67848	31	77826	28	511046	3
20080	78	23578	91	26534	38	38184	54	58409	65	67848	52	77848	28	611003	143
20080	148	23579	92	26617	113	38270	46	58411	82	68320	10	78371	5	611035	141
20465	54	23642	106	26617	134	38410	82	58411	82	68370	11	78419	88	611037	3
20554	23	23580	83	27842	44	38410	82	58591	14	68371	9	78591	14	611044	9
20554	53	23580	90	28008	139	38411	82	58792	98	68408	84	79183	13	611203	3
21311	154	23580	96	28009	139	38412	85	61427	145	68410	80	79187	13	612526	150
22082	147	23609	102	28183	47	38413	85	62263	79	68410	80	79189	13	614702	39
22083	147	23612	102	28270	47	38415	85	62354	146	68411	64	79203	12	614918	39
22085	147	23613	102	28401	67	38417	4	62362	146	68412	79	79204	12	623896	136
22263	64	23614	101	28402	67	38417	7	62363	146	68412	67	79205	12	628407	64
22270	25	23615	101	28403	67	38417	42	62369	68	68550	21	79274	27	628408	65
		23616	101											628410	66
														638407	79
														648407	84
														648408	82
														662373	70
														662374	70
														668408	84
														711044	5
														711203	5
														712596	13
														C135	155
														H14427	92
														H84427	92
														i8370	16
														i8371	16
														i9272	36
														i9274	36
														i9953	16
														i9957	34
														R6533	16
														R6533	18
														R6533	38
														R66533	9
														S67518	9
														S67819	9
														S67826	30
														S67862	30
														S7518	16
														S77518	5
														S77819	5
														S77826	27
														S77862	27
														S7819	16
														S7826	34
														S7862	36
														T67518	10
														T67826	31
														T7518	17
														T77518	6
														T77826	28
														T7826	35

LÍNEAS U-LIGHT / C-LIGHT

Convierte un Producto Perfiletto En Algo Extraordinario



Armado Horizontal Superior

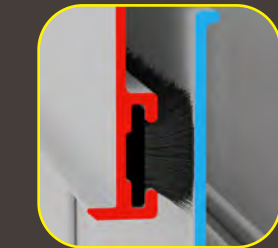
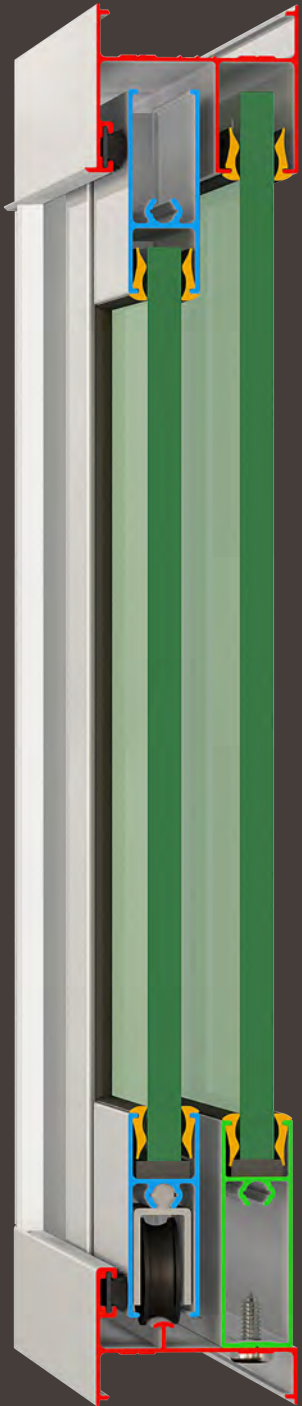

Más Acercamiento de Felpas Logrando **MAYOR HERMETICIDAD**

Fijación de Traslape al Contramarco con Escuadra de Acrilonitrilo de Alta Resistencia

Disponibles en 3 Colores

- Espacios de Contramarcos con Diseño para:
- Aumentar Hermeticidad
 - Correcto Acristalamiento



Venas de Armado Rápido

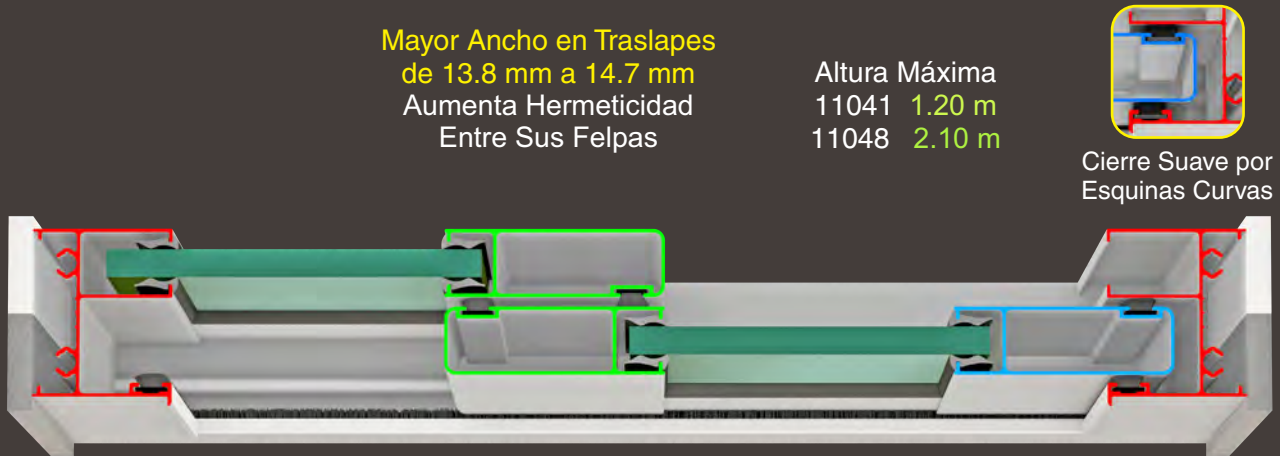

Cierre Suave por Esquinas Curvas



Mayor Acercamiento de Felpa con Zoclo

Zoclo de Hoja Fija con Mayor Resistencia ante Ráfagas de Viento



ATORNILLAR POR FUERA

Pijas sin Contacto con el Cristal

Cerro Traslape 11048 Descubre otras Opciones para tu Cancelería

Cerco 11048 Recibe Broche de Embutir 914

Mosquitero Fijo 7336

Cerco 11047 y Jaladera Broche 190

■ Aislamiento Acústico Ventana 34.0 Decibles Puerta 36.5 Decibles

■ Permeabilidad a Viento y Polvo Ventana Aire que Detiene 86% Puerta Aire que Detiene 89%

■ Resistencia A Vientos Sin Deformar el Perfil Ventana 100 Km/h Puerta 90 Km/h

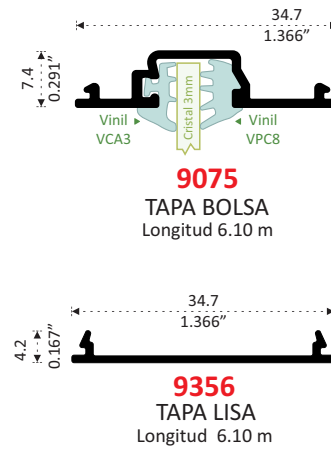
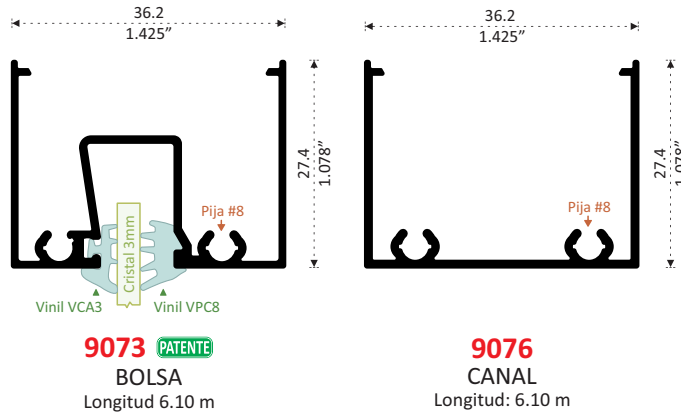

LÍNEA FIJA
AISLAMIENTO
41.6 Decibeles
CRISTAL DE 3 mm

PERFIL ESPECIAL PARA ROLAR

9072
BOLSA CORTA TEMPLE T1
Longitud 6.10 m

Es Alterado El Temple T1, durante el Proceso de Pintura Electrostatica

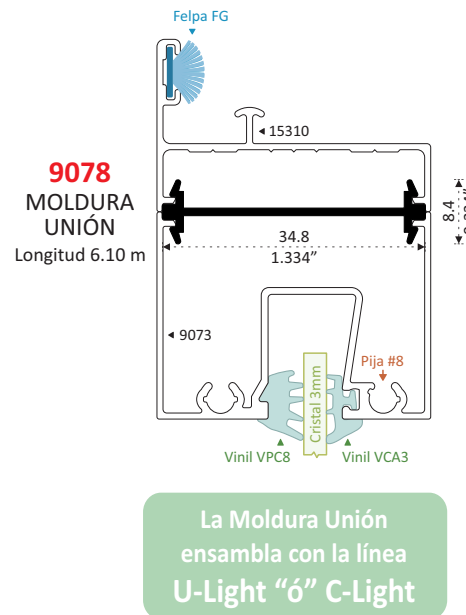
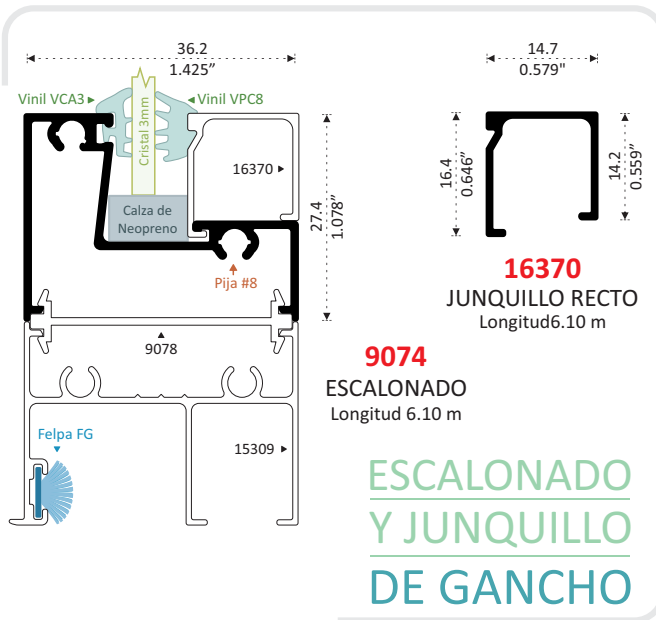

ESCALONADO Y JUNQUILLO A PRESIÓN

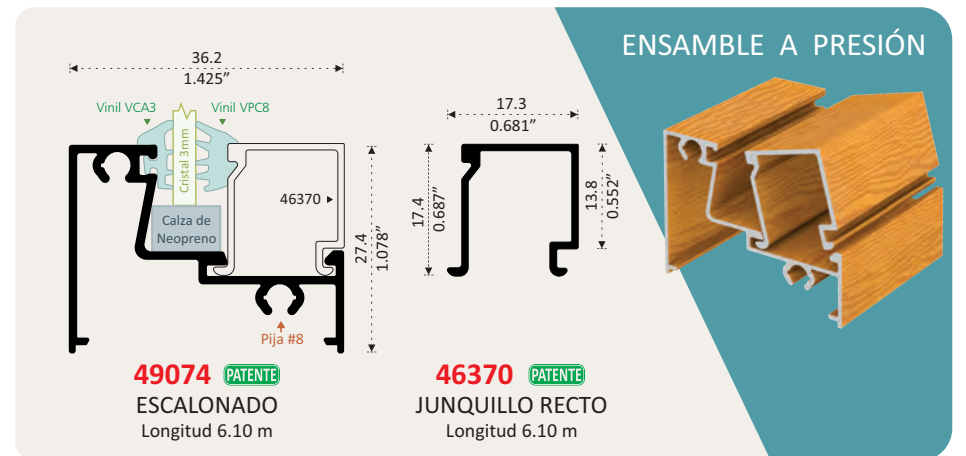

VENTANA DE GUILLOTINA

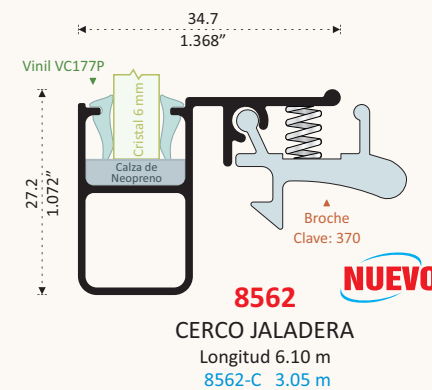
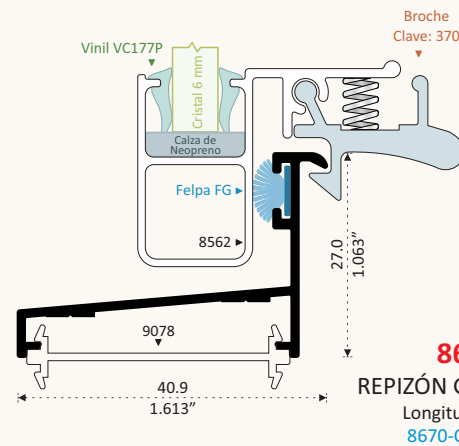

LÍNEA U-LIGHT

PRUEBAS EN NUESTRO CENTRO DE INVESTIGACIÓN Y DESARROLLO Armadas con Perfiles y Complementos Esenciales 100% Perfiletto

AISLAMIENTO ACÚSTICO REALIZADO CON 120 DECIBELES AL EXTERIOR MEDIDA 1.00 x 1.00 m

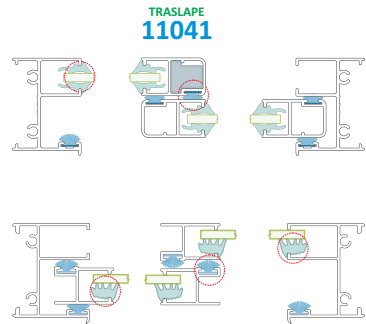

TRASLAPE 11041

7 mm CRYSTAL 3 mm
5 mm
Clave: FG Comercial VC12 Ambos lados

33.2
Decibeles

Perfiletto
ALUMINUM

6%
Más Eficiente

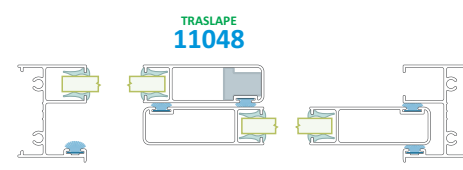

TRASLAPE 11048

7 mm CRYSTAL 6 mm
5 mm
Clave: FG Comercial VC177P Ambos lados

35.1
Decibeles

7 mm CRYSTAL 3 mm
5 mm
Clave: FG Comercial Vinil Pata VP12 Interior

31.5
Decibeles

OTROS
COMPETIDORES

PERMEABILIDAD AL AGUA DURANTE 20 MINUTOS

VENTANA MEDIDA 1.00 x 1.00 m

VELOCIDAD KM/H	Agua	Aire
20	50%	50%
40	50%	50%
60	50%	50%
80	50%	50%
100	50%	50%
120	60%	40%

SIN MOSQUITERO

Sin
Filtraciones

MOSQUITERO FIJO 11763

Sin
Filtraciones

MOSQUITERO FIJO 7336

Sin
Filtraciones

Otros Mosquiteros Fijos Ocasionan Filtraciones Por su Altura Mayor Respecto al Riel

PERMEABILIDAD AL VIENTO Medida 1.00 x 1.00 m

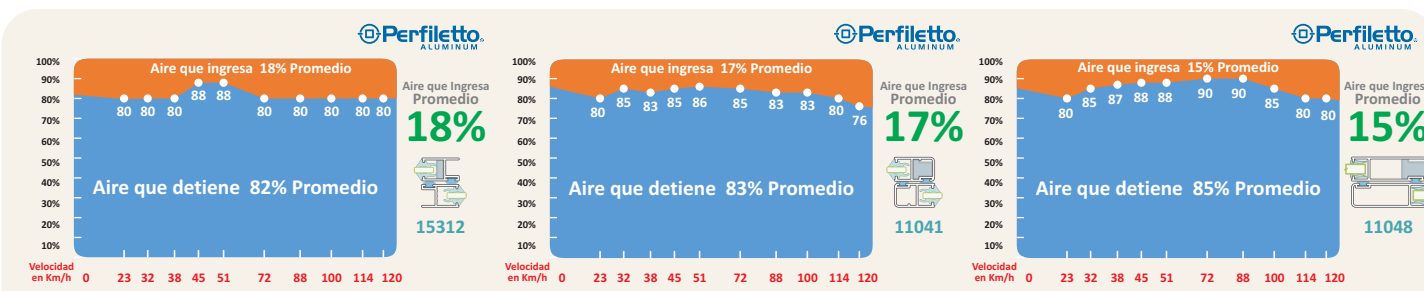

OTROS COMPETIDORES

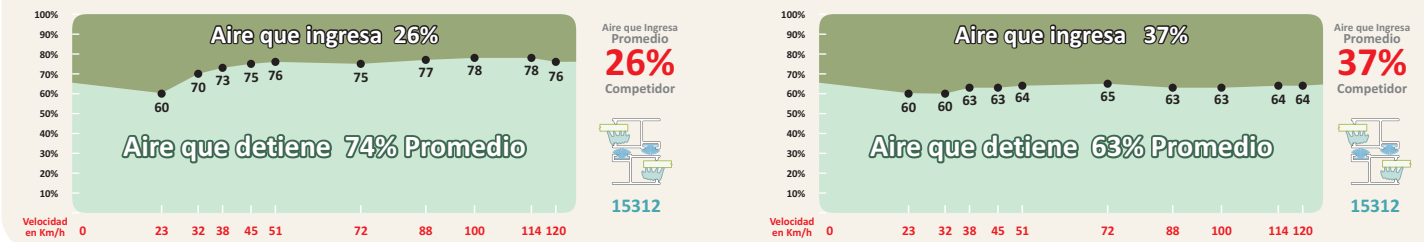

RESISTENCIAS A VIENTOS

VENTANA

Prueba Realizada **Traslapes 11041**
30 Repeticiones de 1 Minuto c/u
A 85 Km/h

Medida 1.00 x 1.00 m
Cristal 3 mm

LOS PERFILES SIN DEFORMACIÓN
CONSERVAN SU
FUNCIONAMIENTO

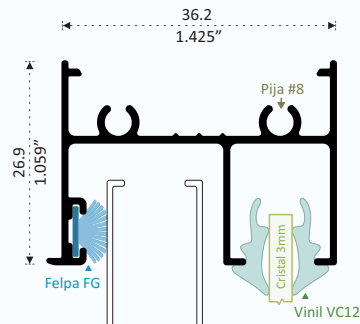

15309
CONTRAMARCO
Longitud 6.10 m

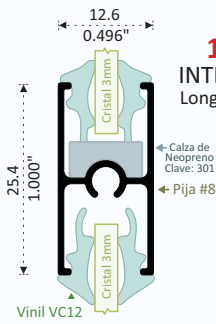

15314
INTERMEDIO
Longitud 6.10 m

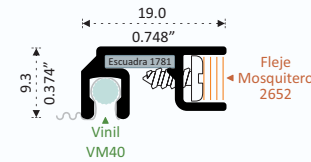

11096
MOSQUITERO
DESMONTABLE
Longitud 6.10 m



Fijación Exterior en Hoja Fija:
- Facilita su Instalación.
- Mayor Resistencia a Vientos.

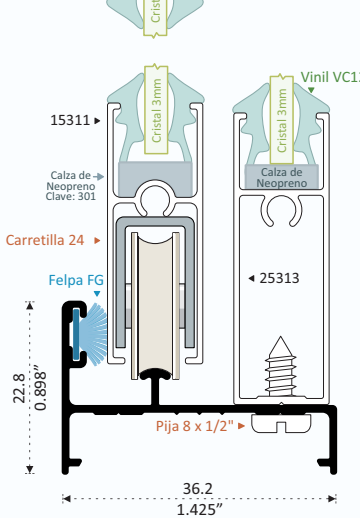

15310
RIEL
Longitud 6.10 m

15311
ZOCLO Y CABEZAL
Longitud 6.10 m

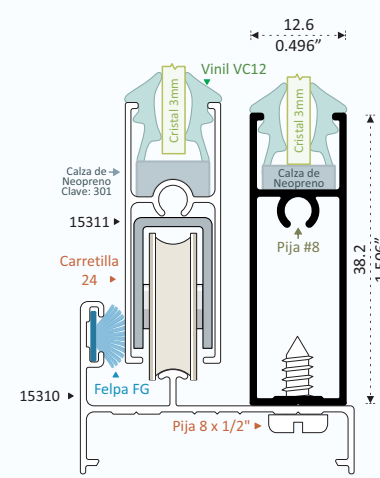
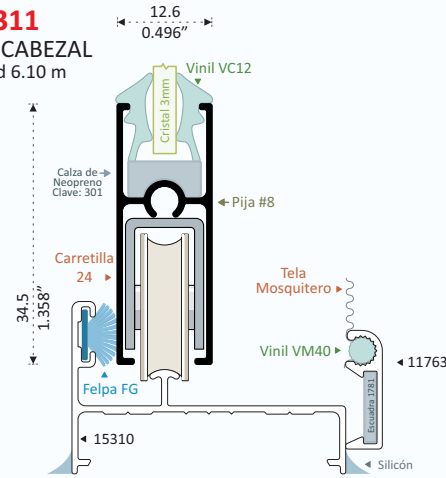

25313 PATENTE
ZOCLO FIJO
Longitud 6.10 m

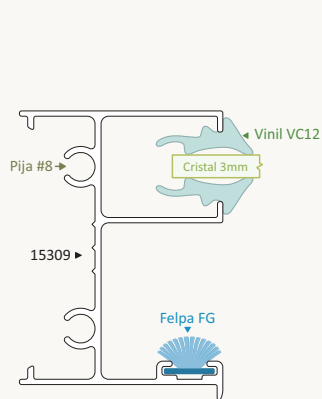

Traslape
Altura Máxima 1.20 m

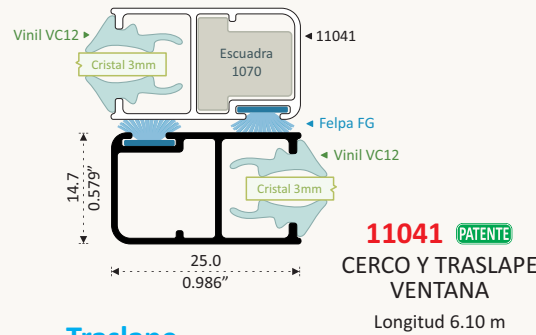

11041 PATENTE
CERCO Y TRASLAPE
VENTANA
Longitud 6.10 m

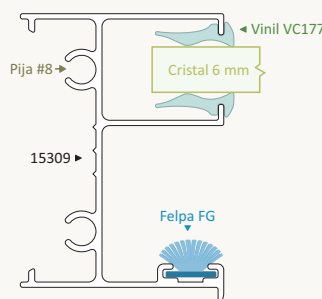

Traslape
Altura Máxima 2.10 m

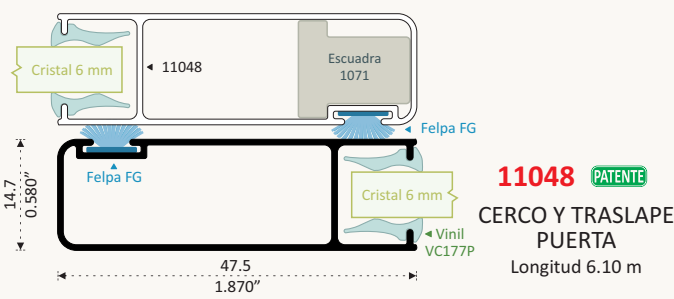

11048 PATENTE
CERCO Y TRASLAPE
PUERTA
Longitud 6.10 m



Estrías en Perfil y Vinil
Logrando Mayor Tensión
a la Tela Mosquitero
Sin Salirse de su Lugar

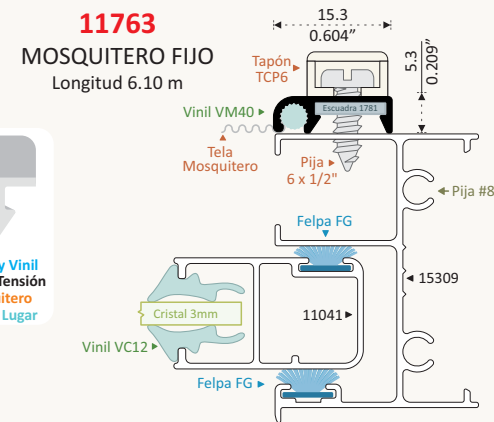

11763
MOSQUITERO FIJO
Longitud 6.10 m

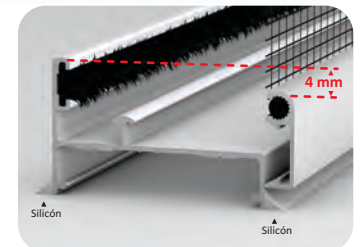

Mosquitero 11763 en Riel

Traslape
Altura Máxima 1.00 m

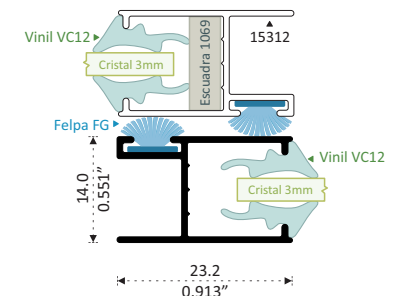

15312
CERCO Y TRASLAPE
VENTANA
Longitud 6.10 m

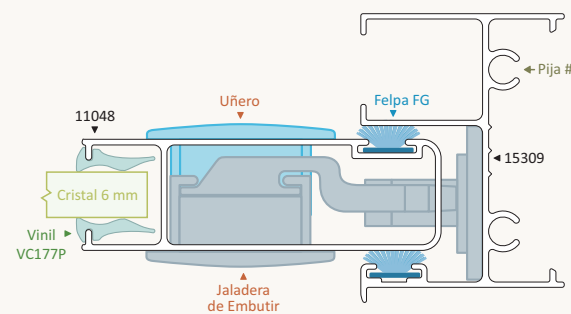

LÍNEA C-LIGHT

PRUEBAS EN NUESTRO CENTRO DE INVESTIGACIÓN Y DESARROLLO Armadas con Perfiles y Complementos Esenciales 100% Perfiletto



AISLAMIENTO ACÚSTICO

REALIZADO CON 120 DECIBELES AL EXTERIOR

MEDIDA 1.00 x 1.00 m

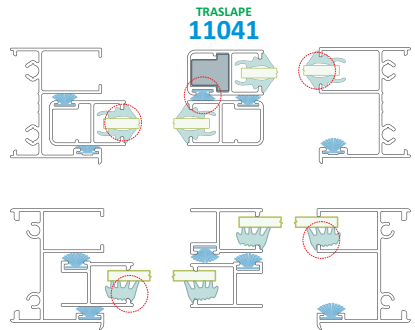

TRASLAPE 11041

7 mm CRISTAL 3 mm AISLAMIENTO

Clave: FG Comercial VC12 Ambos lados

34.0 Decibeles

Perfiletto ALUMINUM

8% Más Eficiente

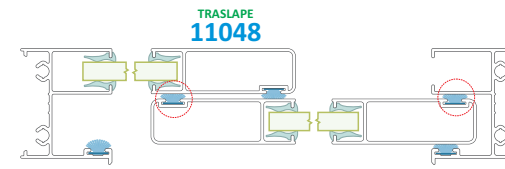

TRASLAPE 11048

7 mm CRISTAL 6 mm AISLAMIENTO

Clave: FG Comercial VC177P Ambos lados

36.5 Decibeles

7 mm CRISTAL 3 mm AISLAMIENTO

Clave: FG Comercial Vinil Pata VP12 Interior

31.5 Decibeles

OTROS COMPETIDORES

LÍNEA EXCLUSIVA PERFILETTO

PERMEABILIDAD AL AGUA DURANTE 20 MINUTOS

VENTANA MEDIDA 1.00 x 1.00 m

VELOCIDAD KM/H	Agua	Aire
20	50%	50%
40	50%	50%
60	50%	50%
80	50%	50%
100	50%	50%
120	60%	40%

SIN MOSQUITERO

Sin Filtraciones

MOSQUITERO FIJO 11763

Sin Filtraciones

MOSQUITERO FIJO 7336

Sin Filtraciones

Otros Mosquiteros Fijos Ocasianan Filtraciones Por su Altura Mayor Respecto al Riel

VELOCIDAD KM/H	Agua	Aire
20	50%	50%
40	50%	50%
60	50%	50%
80	50%	50%
100	50%	50%
120	60%	40%

SIN MOSQUITERO

Sin Filtraciones

MOSQUITERO CORREDIZO INTERIOR

Sin Filtraciones

MOSQUITERO CORREDIZO EXTERIOR RIEL 7817 Y ZOCLO 66533

VELOCIDAD KM/H	Agua	Aire	Litros Filtrados
20	50%	50%	1.50
40	50%	50%	1.82
60	50%	50%	1.89
80	50%	50%	2.55
100	50%	50%	2.93
120	60%	40%	3.30

MOSQUITERO CORREDIZO EXTERIOR OCASIONA ALTA FILTRACIÓN DE AGUA

PERMEABILIDAD AL VIENTO Medida 1.00 x 1.00 m

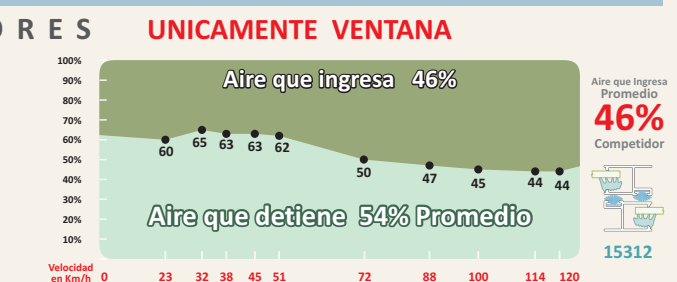
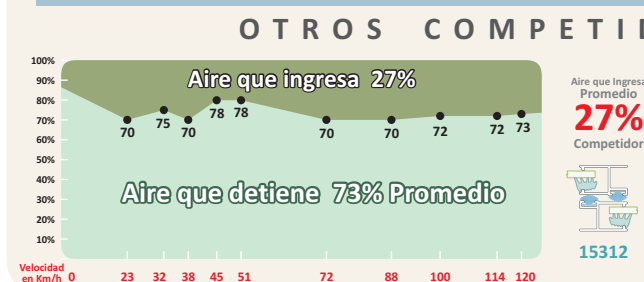
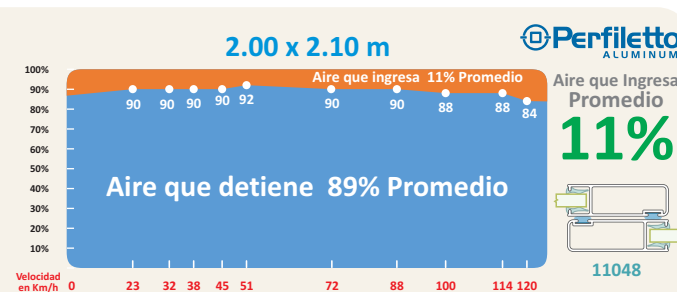
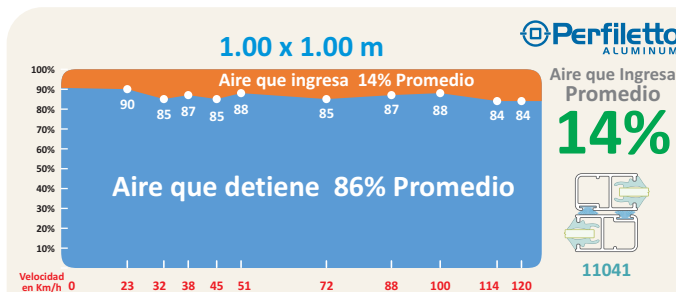

RESISTENCIAS A VIENTOS

VENTANA

Prueba Realizada 30 Repeticiones de 1 Minuto c/u A 100 Km/h Medida 1.00 x 1.00 m Cristal 3 mm LOS PERFILES SIN DEFORMACIÓN CONSERVAN SU FUNCIONAMIENTO

PUERTA

Prueba Realizada 30 Repeticiones de 1 Minuto c/u A 90 Km/h Medida 2.00 X 2.10 m Cristal 6 mm LOS PERFILES SIN DEFORMACIÓN CONSERVAN SU FUNCIONAMIENTO

Ruptura de Cristal a 100 km/h

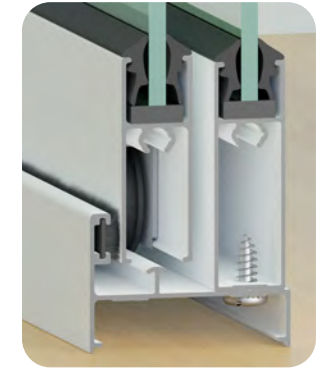
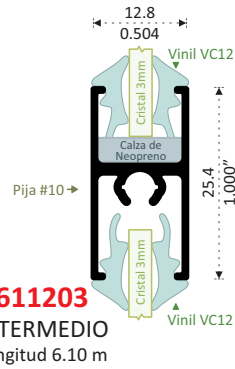
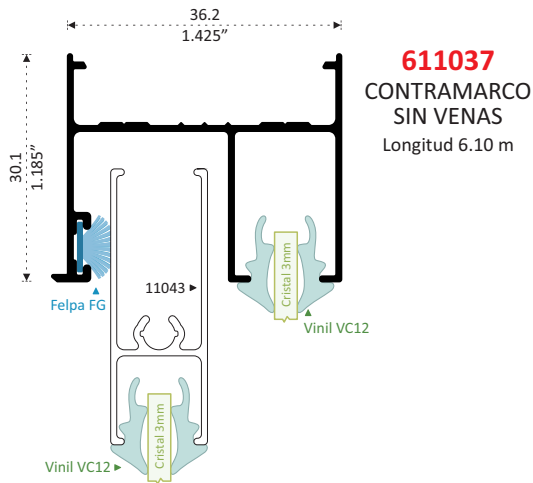

Fijación Exterior en Hoja Fija:
- Facilita su Instalación.
- Mayor Resistencia a Vientos.

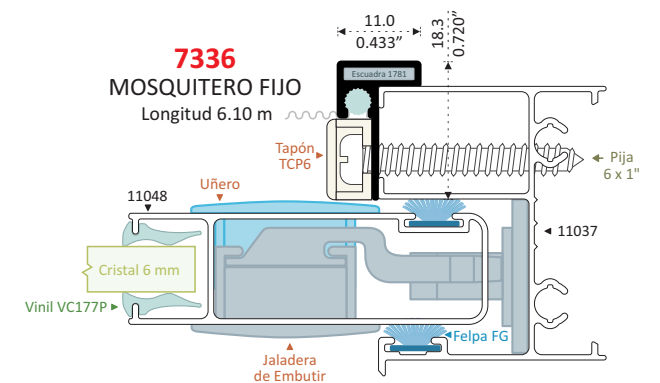
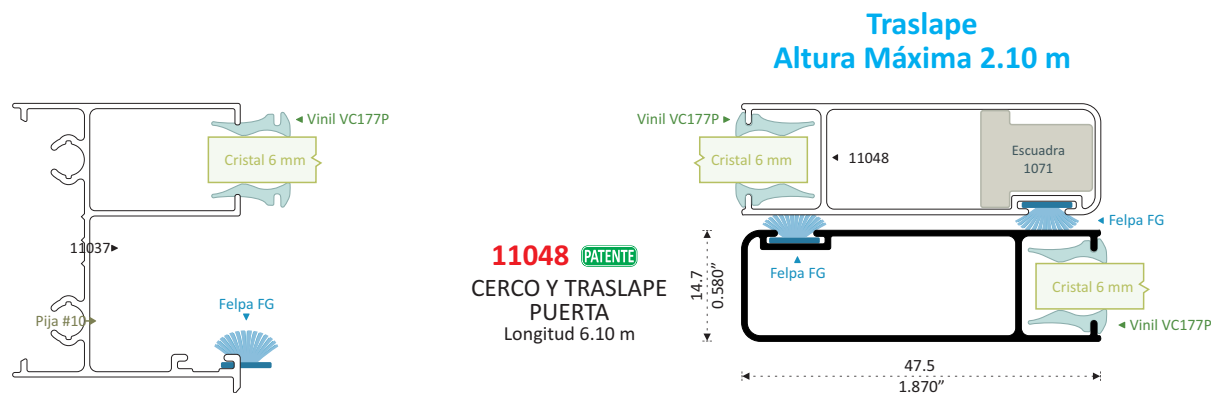
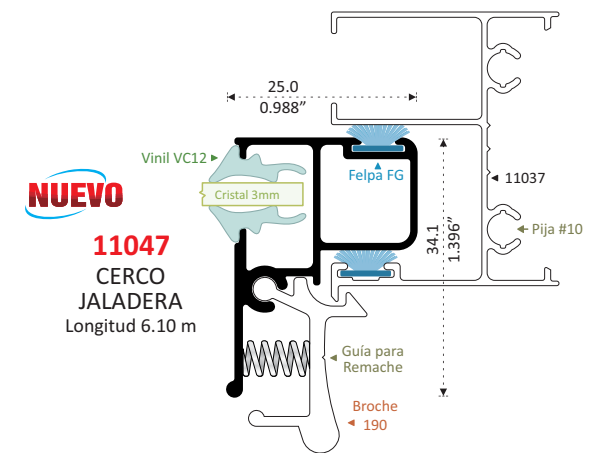
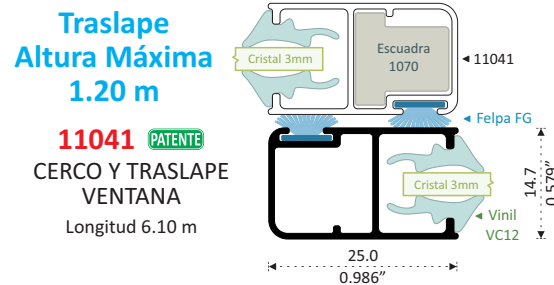
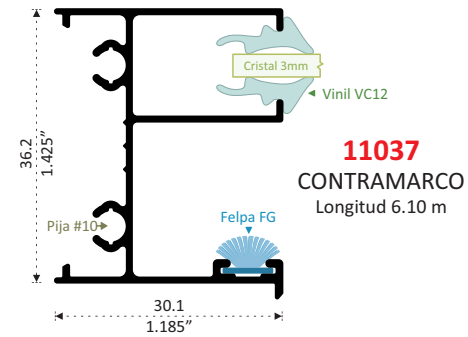
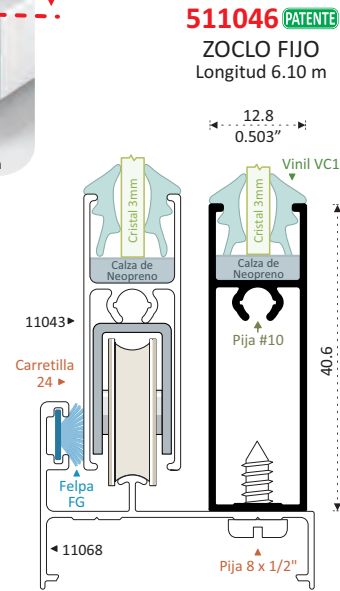
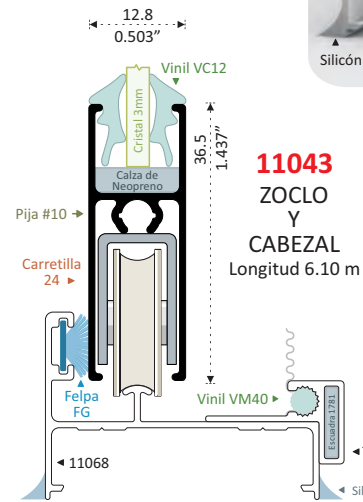
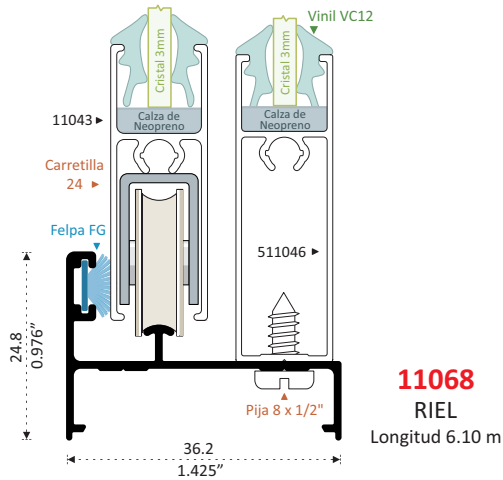

U-LIGHT y C-LIGHT PUERTA BATIENTE

PRUEBAS EN NUESTRO CENTRO DE INVESTIGACIÓN Y DESARROLLO Armadas con Perfiles y Complementos Esenciales 100% Perfiletto



VC11
Ambos lados



FELPA FL6



FELPA F12P



BISAGRA 1909P



AISLAMIENTO ACÚSTICO

REALIZADO CON 120 DECIBELES AL EXTERIOR

MEDIDA 0.95 X 2.20 m

CERCO CHAPA 9236

DUELA 16617

DUCLA 16617

AISLAMIENTO

32.5
Decibeles

CERCO CHAPA 9236

CRISTAL 6 mm

DUCLA 16617

AISLAMIENTO

34.0
Decibeles

CERCO CHAPA 9236

CRISTAL 6 mm

CRISTAL 6 mm

AISLAMIENTO

39.6
Decibeles

PERMEABILIDAD AL AGUA DURANTE 20 MINUTOS

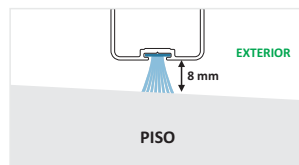

Desnivel de Piso
3° Grados

Sin
Filtraciones

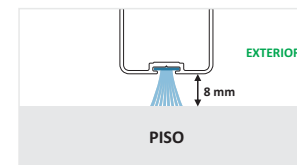

Desnivel de Piso
0° Grados

Con
Filtraciones

PERMEABILIDAD AL VIENTO Medida 1.00 x 1.00 m

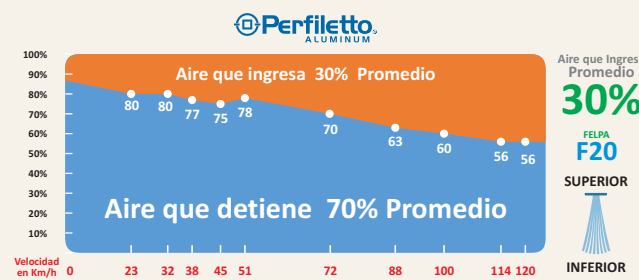
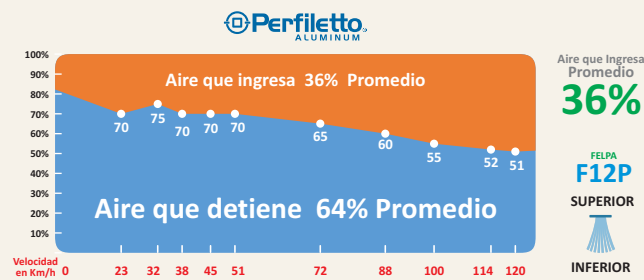

RESISTENCIAS A VIENTOS

PUERTA

Prueba Realizada
30 Repeticiones de 1 Minuto c/u
A 120 Km/h
Medida 0.95 X 2.20 m
Cristal 6 mm
Duela 16617

LOS PERFILES SIN DEFORMACIÓN

CONSERVAN SU
FUNCIONAMIENTO

COMPETIDORES

INGRESA ALTAS CANTIDADES DE AIRE



3.9
0.154"

24.6
0.969"

PATENTE
1208
BARRA REFUERZO
Longitud 3.10 m



CABEZAL

ZOCLO

7838 PATENTE
ZOCLO CABEZAL
Longitud 6.10 m
7838-C 3.05 m
ZE 1.00 m

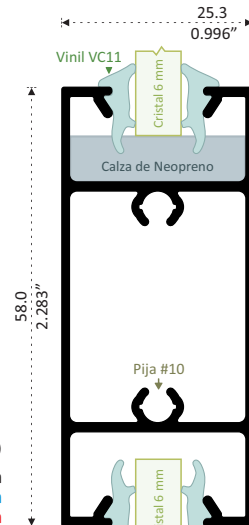
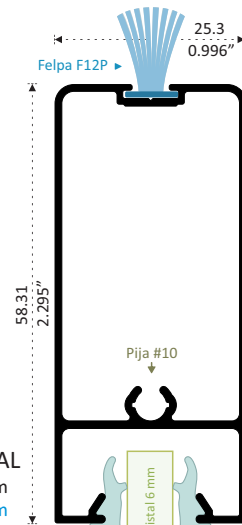

7837 PATENTE
INTERMEDIO
Longitud 6.10 m
7837-C 3.05 m
IPF 0.87 m

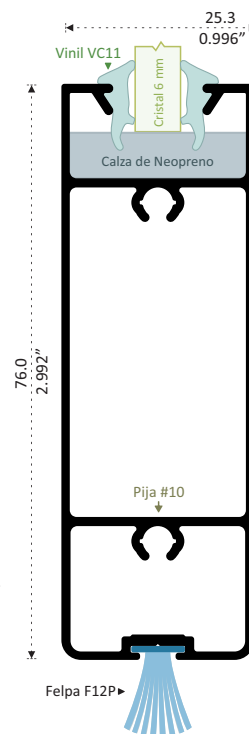

7839 PATENTE
ZOCLO CABEZAL
Longitud 6.10 m
7839-C 3.05 m
ZEC 1.00 m

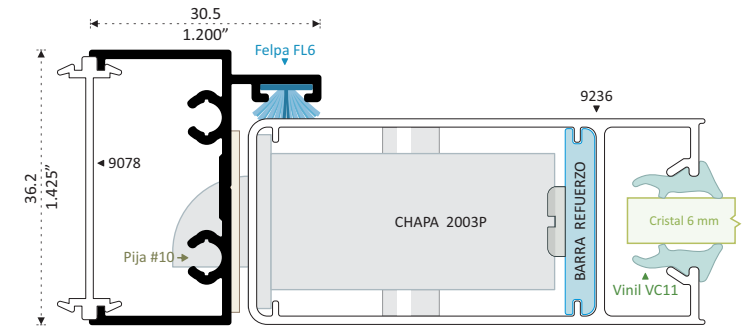

9255
BATIENTE
Longitud 5.50 m
9255-L 6.10 m

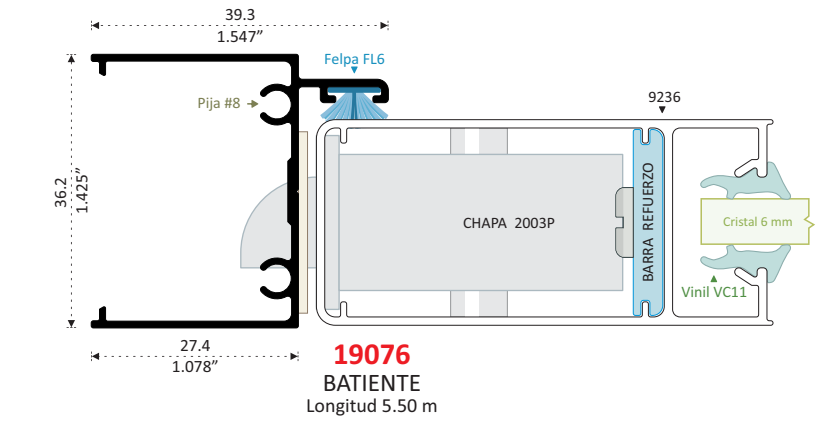

19076
BATIENTE
Longitud 5.50 m

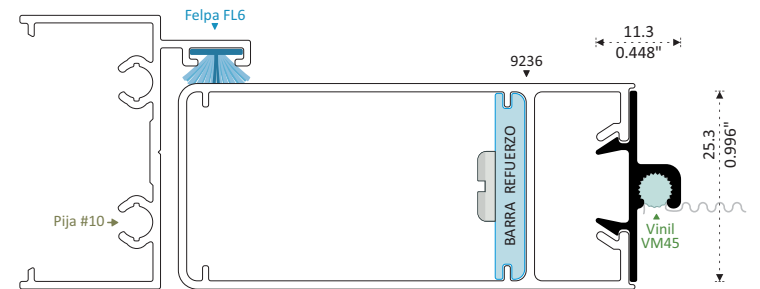

38417
ADAPTADOR MOSQUITERO
Longitud 6.10 m

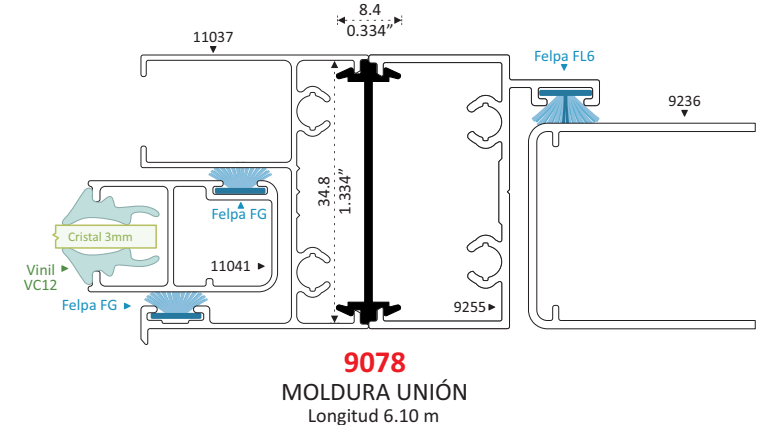

9078
MOLDURA UNIÓN
Longitud 6.10 m

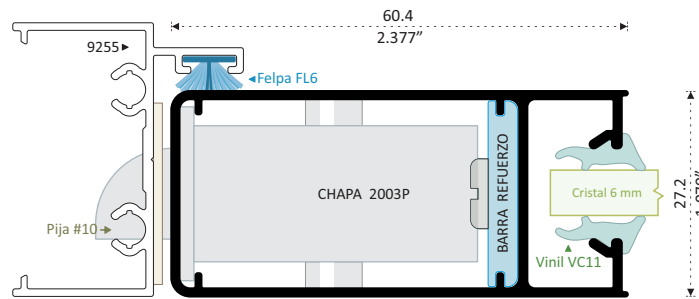

9236 PATENTE
CERCO CHAPA
Longitud 4.60 m
9236-L 6.10 m

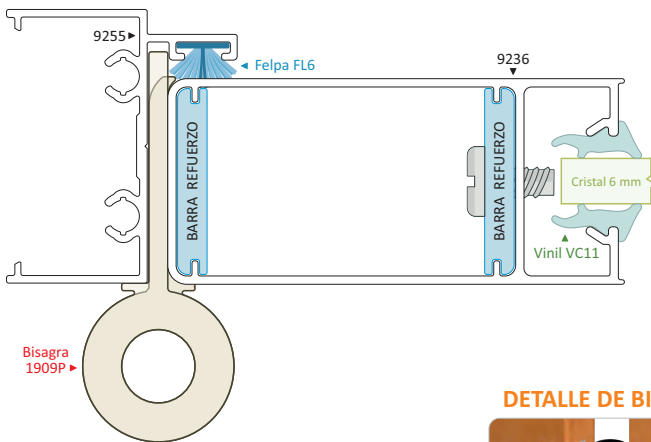

DETALLE DE BISAGRA



Instalación de Bisagras Superior e Inferior Armado de Cerco, Lado donde se Instalan las Bisagras



LÍNEA 2" ECONÓMICA HERMÉTICA

Convierte un Producto Periletto En Algo Extraordinario

Obten **MAYORES GANANCIAS** utilizando contramarco sin venas

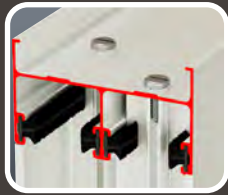

Armado Horizontal Superior

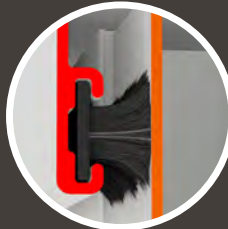

Más Acercamiento de Felpas logrando

MAYOR HERMETICIDAD



MAYOR ACERCAMIENTO de Felpa con Zoclo

Diseño de Contramarco Más Económico



Diseño de Riel Más Económico

Atornillado hoja fija

MÁS RÁPIDO



Atornille una sola vez los Traslapes, Acristale en Mesa Hojas Fija y Corrediza



Colocación Rápida de Hoja Corrediza y Hoja Fija

Con Atornillado por el Exterior, en Zoclo y Cabezal

Pijas sin Contacto con el Cristal

Zoclo de Hoja Fija con **Mayor Resistencia** ante Ráfagas de Viento



ATORNILLAR POR FUERA



Vista Distinguida y Más Económica

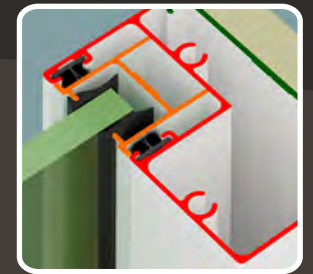

Cerco Fijo da Apariencia de un Perfil Integrado al Contramarco



Fijación Invisible con Moldura de Fijación a Muro

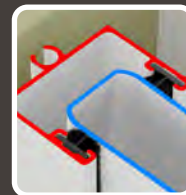

Ofrece la Experiencia de un Cierre Suave y Silencioso

Por Cerco con Esquinas Curvas y Contacto de Felpas al 100%

Cubiertas Traslapes

Maximiza la Hermeticidad a Viento y Polvo, entre Traslapes, Contramarco y Riel hasta un

85%



CTA2

Ventana

Puerta

Descubre otras Opciones para tu Cancelería



Zoclo Puerta

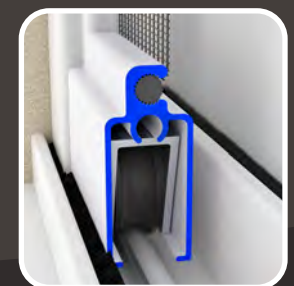

Mosquetero Horizontal Ventana

76533

■ Aislamiento Acústico 79955 34.8 Decibles

■ Permeabilidad a Viento y Polvo 79955 Aire que Detiene 91%

■ Resistencia A Vientos Sin Deformar el Perfil Ventana 120 Km/h Puerta 100 Km/h

AISLAMIENTO ACÚSTICO
REALIZADO CON 120 DECIBELES AL EXTERIOR
MEDIDA 1.00 x 1.00 m

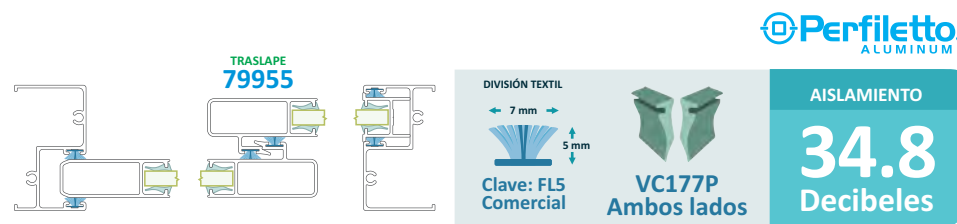

LÍNEA EXCLUSIVA PERFILETTO

PERMEABILIDAD AL AGUA DURANTE 20 MINUTOS

VENTANA MEDIDA 1.00 x 1.00 m

	Agua	Aire
20	50%	50%
40	50%	50%
60	50%	50%
80	50%	50%
100	50%	50%
120	60%	40%

SIN MOSQUITERO

Sin Filtraciones

MOSQUITERO FIJO 11763

Sin Filtraciones

MOSQUITERO FIJO 7336

Sin Filtraciones

Otros Mosquiteros Fijos Ocasionalmente Filtraciones Por su Altura Mayor Respecto al Riel

PUERTA MEDIDA 1.00 x 1.00 m

VELOCIDAD KM/H	Agua	Aire
20	50%	50%
40	50%	50%
60	50%	50%
80	50%	50%
100	50%	50%
120	60%	40%

SIN MOSQUITERO

Sin Filtraciones

MOSQUITERO CORREDIZO INTERIOR

Sin Filtraciones

MOSQUITERO CORREDIZO EXTERIOR RIEL 7817 y ZOCLO 66533

VELOCIDAD KM/H	Agua	Aire	Litros Filtrados
20	50%	50%	1.50
40	50%	50%	1.84
60	50%	50%	1.92
80	50%	50%	2.62
100	50%	50%	3.00
120	60%	40%	3.40

MOSQUITERO CORREDIZO EXTERIOR OCASIONA ALTA FILTRACIÓN DE AGUA

PERMEABILIDAD AL VIENTO Medida 1.00 x 1.00 m

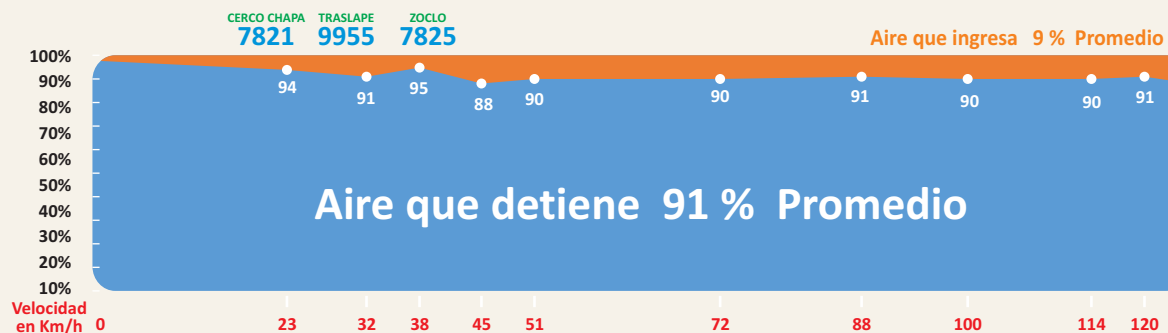

Aire que Ingresa Promedio **9%**



LÍNEA EXCLUSIVA PERFILETTO

RESISTENCIAS A VIENTOS

VENTANA

Prueba Realizada
30 Repeticiones de 1 Minuto c/u
A 120 Km/h
Medida 1.00 x 1.00 m
Cristal 6 mm
LOS PERFILES SIN DEFORMACIÓN
CONSERVAN SU FUNCIONAMIENTO

PUERTA

Prueba Realizada
30 Repeticiones de 1 Minuto c/u
A 100 Km/h
Medida 2.00 X 2.10 m
Cristal 6 mm
LOS PERFILES SIN DEFORMACIÓN
CONSERVAN SU FUNCIONAMIENTO

Ruptura de Cristal a 110 km/h

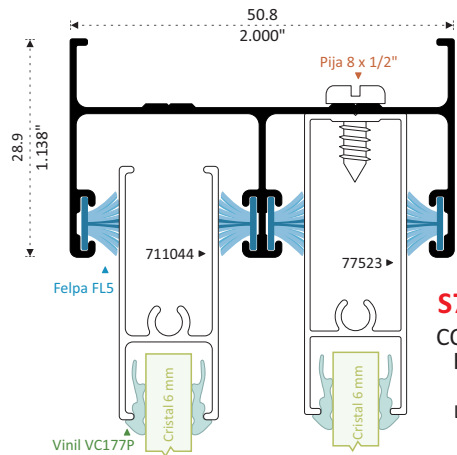

S77518 PATENTE
CONTRAMARCO
HORIZONTAL
SIN VENAS
Longitud 6.10 m



Nuevo perfil con
mayor hermeticidad
entre felpas y aluminio

S77819
CONTRAMARCO
MOSQUITERO
CORREDIZO
SIN VENAS
Longitud 6.10 m

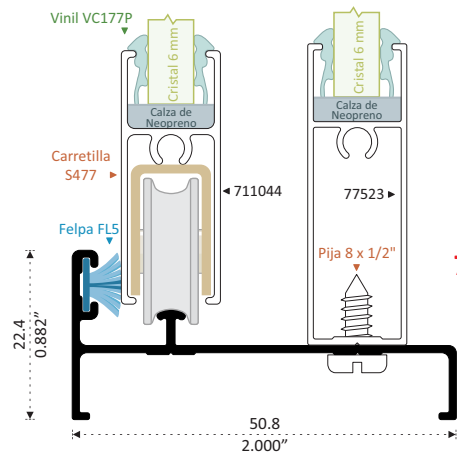
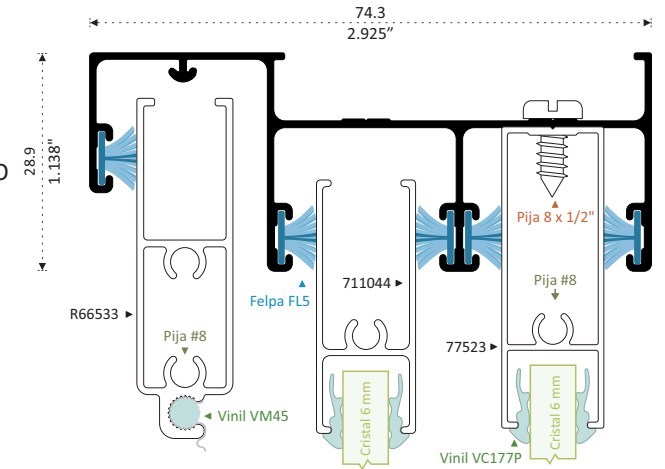

79953 PATENTE
RIEL
Longitud 6.10 m

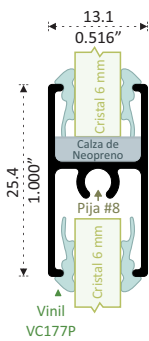

711203
INTERMEDIO
Longitud 6.10 m

78371
RIEL
MOSQUITERO
INTERIOR
Longitud 6.10 m

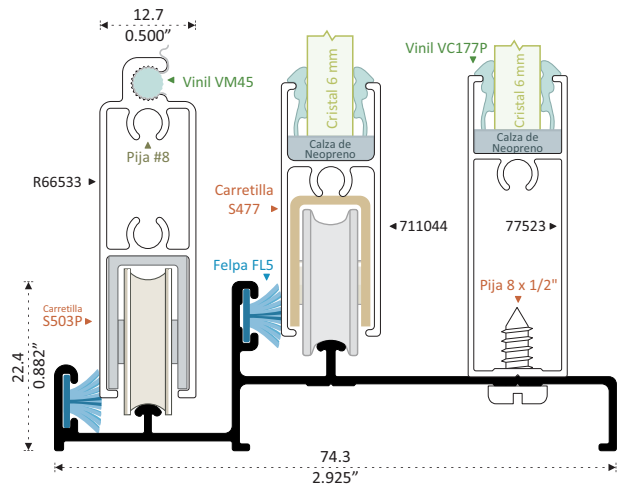

711044
ZOCLO Y CABEZAL
Longitud 6.10 m

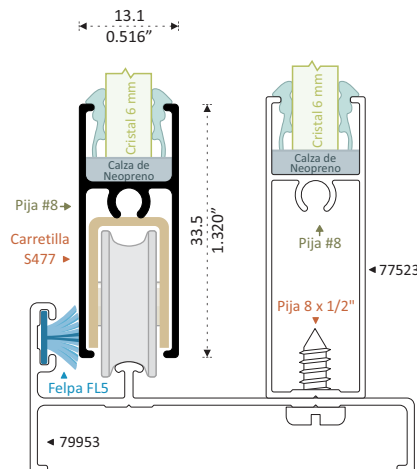

77523 PATENTE
ZOCLO FIJO
Longitud 6.10 m

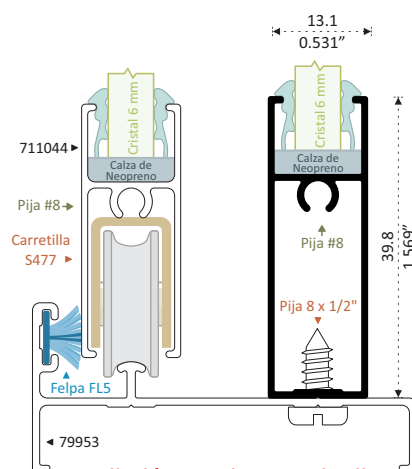

Fijación Exterior en Hoja Fija:
- Facilita su Instalación.
- Mayor Resistencia a Vientos.

NUEVO
76533
MOSQUITERO
HORIZONTAL
Longitud 6.10 m

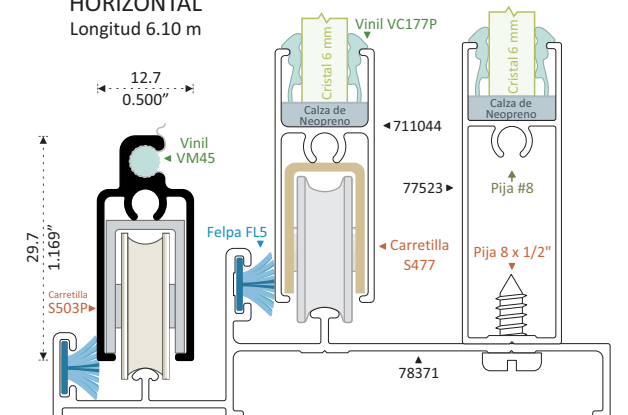

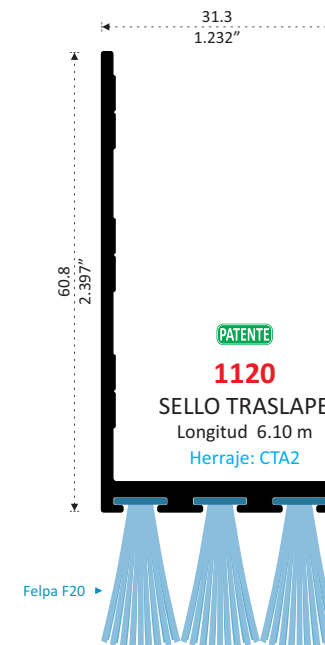
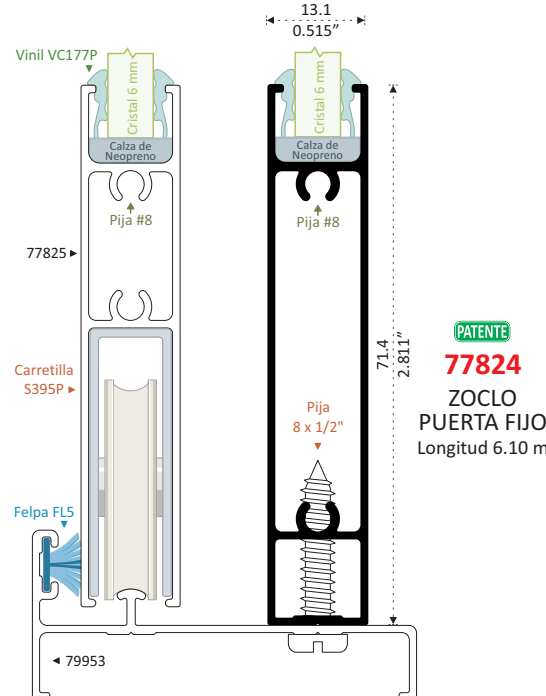
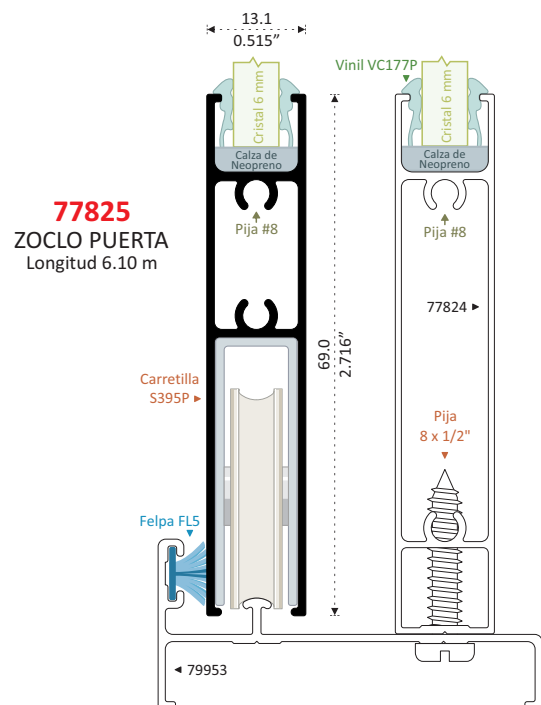
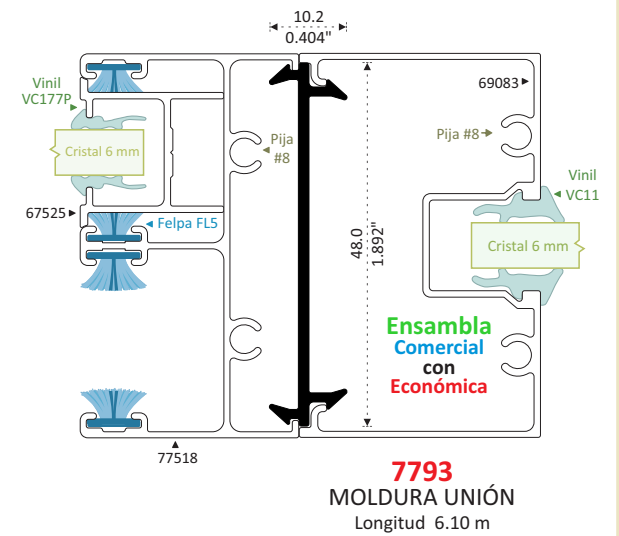
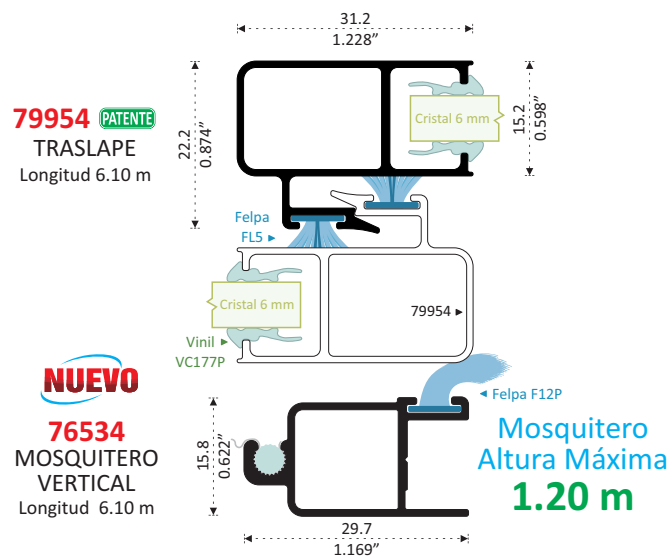
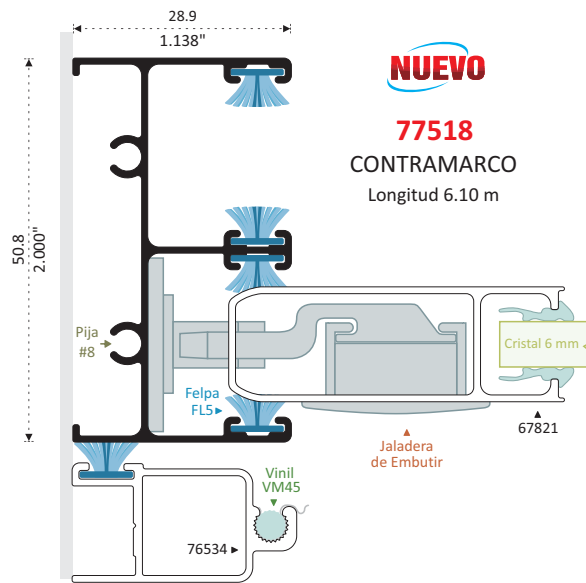
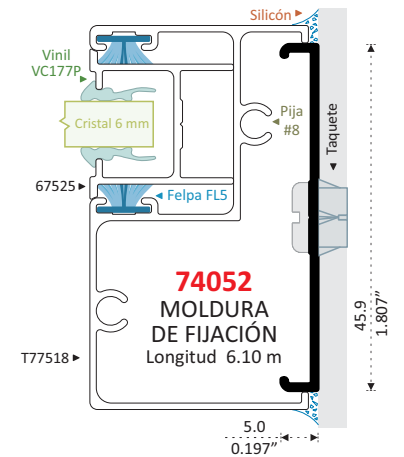
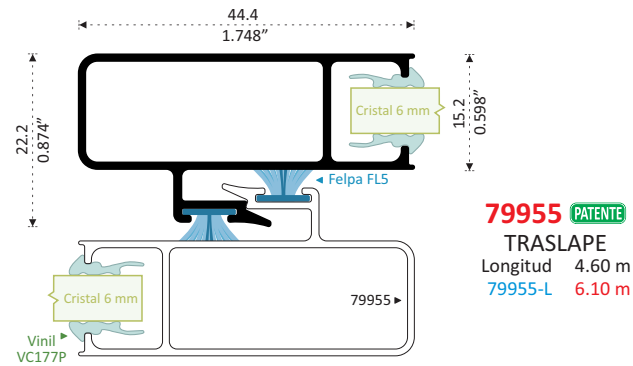
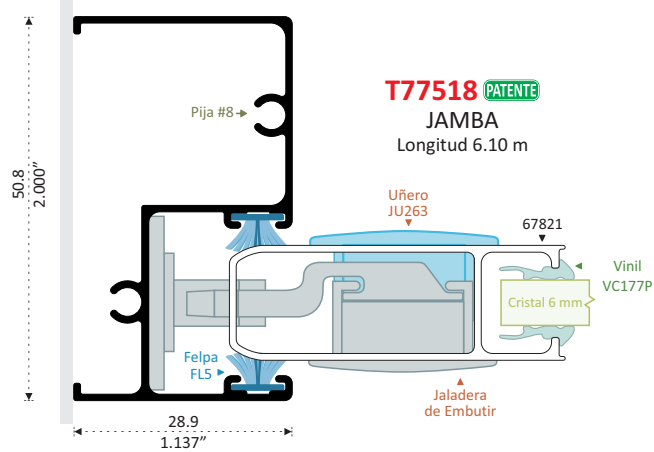

Colocar en Traslape de Hoja Móvil

NUEVO

Ventana y Puerta Línea 2"
Cubiertas Traslape
Herraje: CTA2 Par

LÍNEA 2" ECONÓMICA PUERTA BATIENTE

Convierte un Producto Perfiletto En Extraordinario

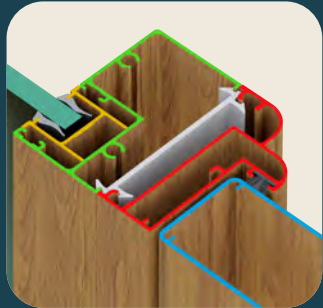

Combinable con 2"



Mayor Hermeticidad y Aislamiento entre Batiente y Cabezal por sus Dos Felpas



Barra Superior



Barra Inferior



Barras para Bisagras

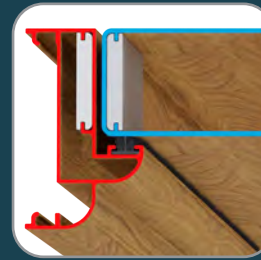

Batiente y Cerco Chapa con Entradas para Barra Refuerzo

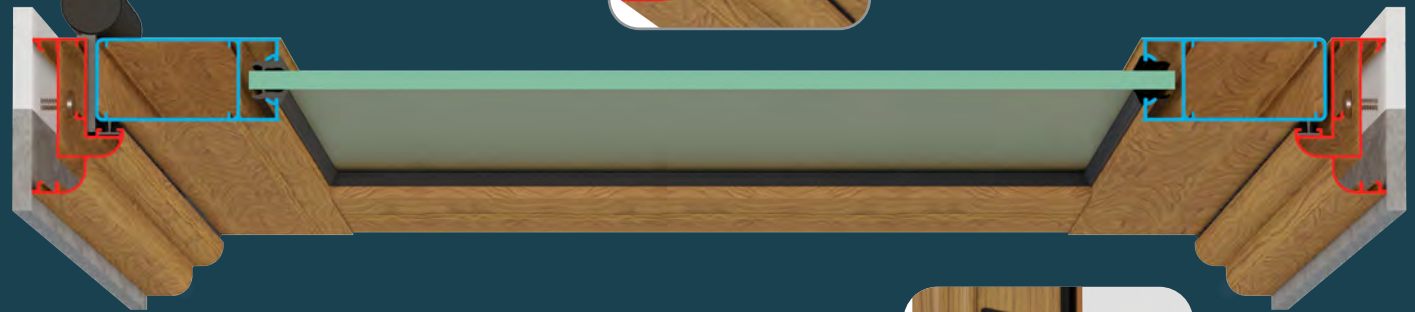

Espacio para Colocar Chapa Doble Manija



Descubre otras Opciones para tu Cancelería



Felpa F12P

Mayor Hermeticidad y Aislamiento Por su Felpa en Zoco

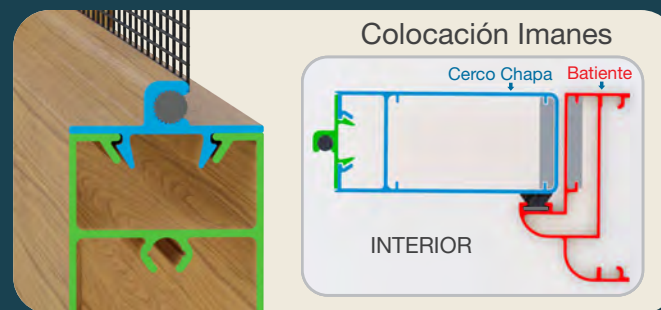

Adaptador Mosquitero



Puedes colocar imán para mejorar el cierre

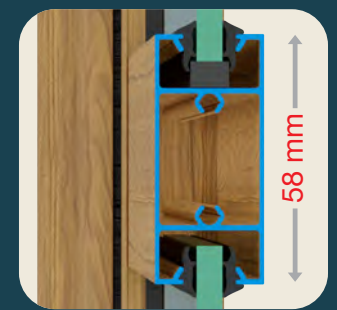

Intermedio 7837

■ Aislamiento Acústico

Duela-Duela 32.5 Decibles
Cristal-Duela 34.0 Decibles
Cristal-Cristal 39.6 Decibles

■

Permeabilidad a Viento y Polvo

Con Felpa F12P
Con Felpa F20

Aire que Detiene 64%
Aire que Detiene 70%

■

Resistencia A Vientos Sin Deformar el Perfil

Puerta 120 Km/h

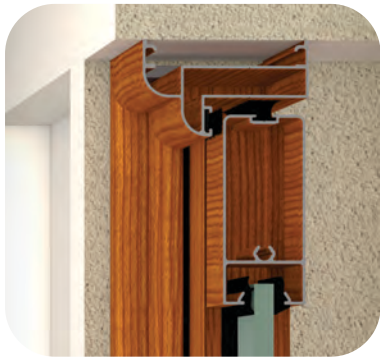

1208 PATENTE
BARRA REFUERZO
Longitud 3.10 m

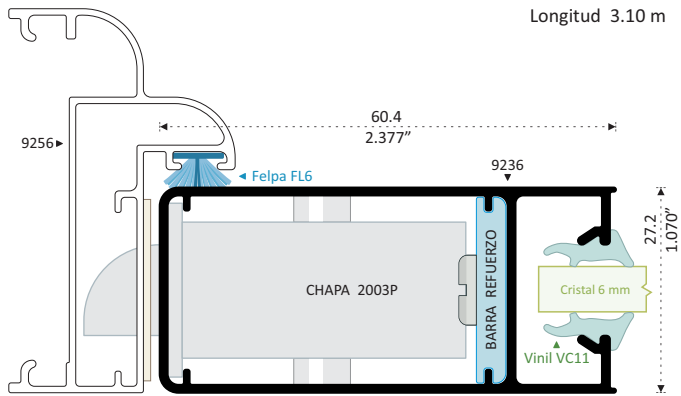

9236 PATENTE
CERCO CHAPA
Longitud 4.60 m
9236-L 6.10 m

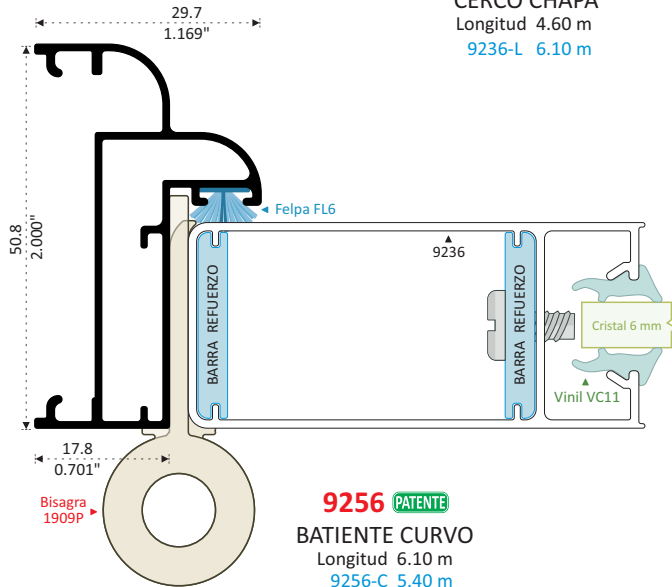

9256 PATENTE
BATIENTE CURVO
Longitud 6.10 m
9256-C 5.40 m

DETALLE DE BISAGRA



Instalación de Bisagras Superior e Inferior
Armado de Cerco, Lado donde se Instalan las Bisagras

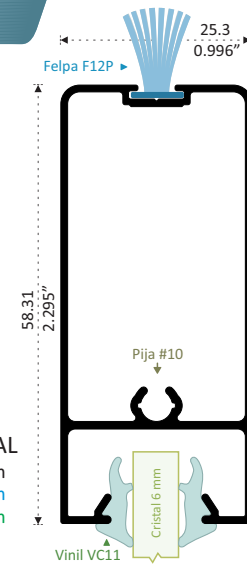

7838 PATENTE
ZOCLO CABEZAL
Longitud 6.10 m
7838-C 3.05 m
ZE 1.00 m

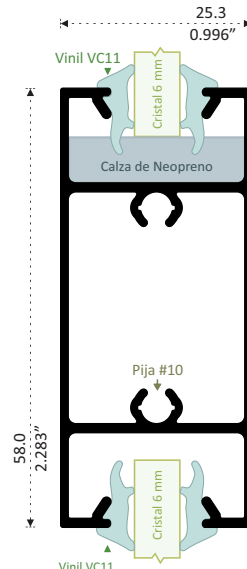

7837 PATENTE
INTERMEDIO
Longitud 6.10 m
7837-C 3.05 m
IPF 0.87 m

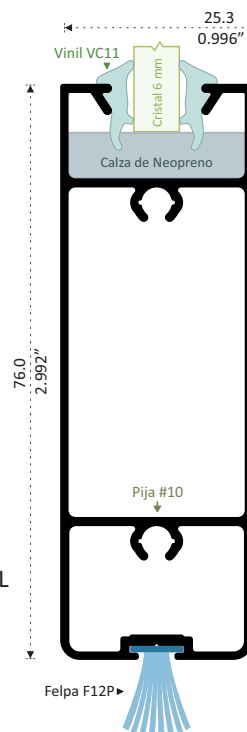

7839 PATENTE
ZOCLO CABEZAL
Longitud 6.10 m
7839-C 3.05 m
ZEC 1.00 m



Puerta Mosquero
Cierre con Imanes



38417
ADAPTADOR MOSQUERO
Longitud 6.10 m

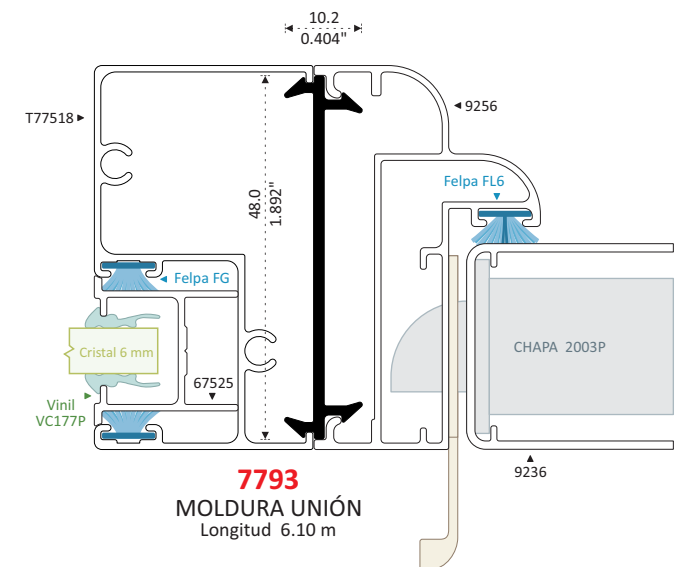

7793
MOLDURA UNIÓN
Longitud 6.10 m



 **Perfiletto**[®]
ALUMINUM

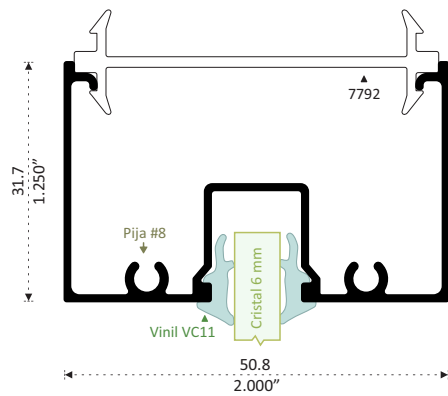

69083
BOLSA
Longitud 6.10 m

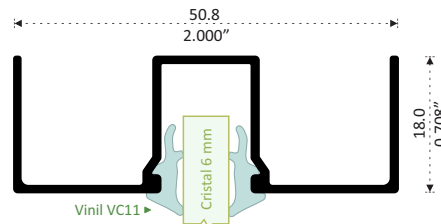

PATENTE 9086
BOLSA CORTA 2" TEMPLE T1
Longitud 6.10 m

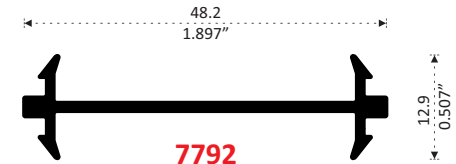

7792
MOLDURA UNIÓN
Longitud 6.10 m

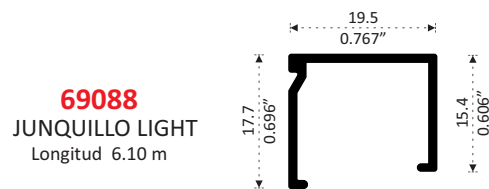
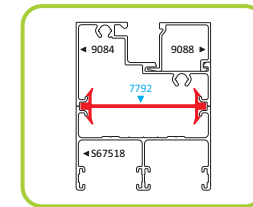

69088
JUNQUILLO LIGHT
Longitud 6.10 m

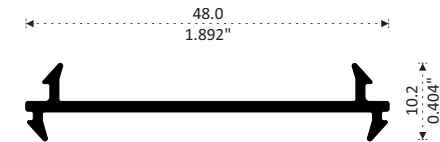

7793
MOLDURA UNIÓN
Longitud 6.10 m

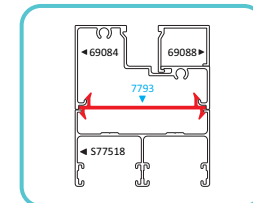

Ensambla
2"
Light
con
Económica

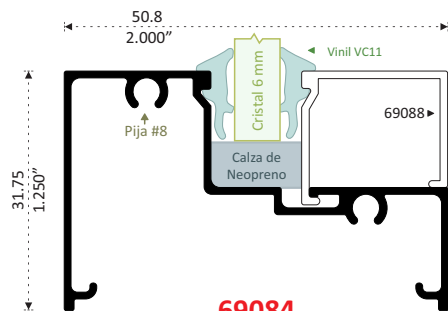

69084
ESCALONADO
Longitud 6.10 m

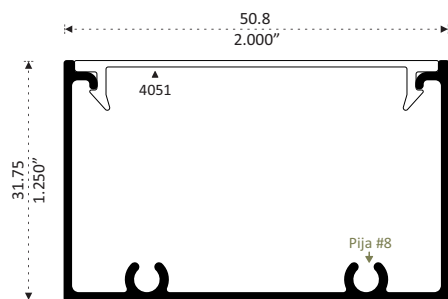

68591
CANAL
Longitud 6.10 m

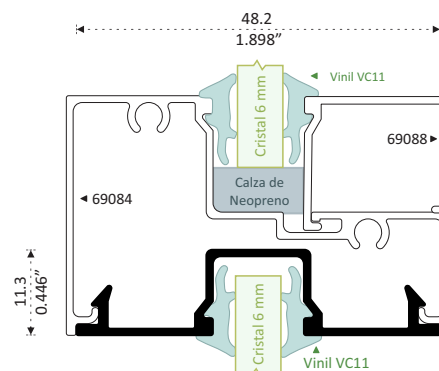

69085
TAPA BOLSA
Longitud 6.10 m

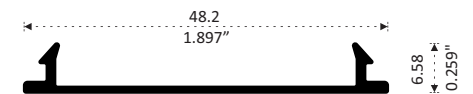

4051
TAPA LISA
Longitud 6.10 m

LÍNEA 2" LIGHT HERMÉTICA

Convierte un Producto Periletto En Extraordinario

Obten **MAYORES GANANCIAS** utilizando contramarco sin venas



Armado Horizontal Superior

Atornillado hoja fija

MÁS RÁPIDO



Atornille una sola vez los Traslapes, Acristale en Mesa Hojas Fija y Corrediza



Colocación Rápida de Hoja Corrediza y Hoja Fija Con Atornillado por el Exterior, en Zoclo y Cabezal Pijas sin Contacto con el Cristal

Más Acercamiento de Felpas logrando **MAYOR HERMETICIDAD**



MAYOR ACERCAMIENTO de Felpa con Zoclo



Zoclo de Hoja Fija con Mayor Resistencia ante Ráfagas de Viento

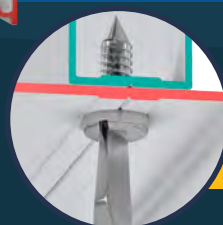

ATORNILLAR POR FUERA



Vista Distinguida y Más Económica



Cerco Fijo da Apariencia de un Perfil Integrado al Contramarco

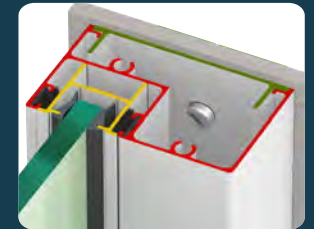

Fijación Invisible con Moldura de Fijación a Muro



Ofrece la Experiencia de un Cierre Suave y Silencioso

Por Cerco con Esquinas Curvas y Contacto de Felpas al 100%

Cubiertas Traslapes



Maximiza la Hermeticidad a Viento y Polvo, entre Traslapes, Contramarco y Riel hasta un **85%**

Descubre otras Opciones para tu Cancelería

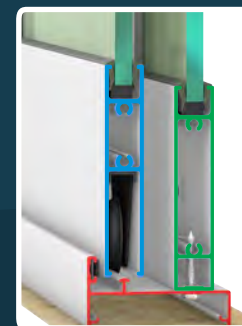

Zoclo Puerta



Mosquitero Horizontal Doble Vena **R66533**

■ Aislamiento Acústico 69955 36.0 Decibles

■ Permeabilidad a Viento y Polvo 69955 Aire que Detiene 92 %

■ Resistencia A Vientos Sin Deformar el Perfil Ventana 120 Km/h Puerta 100 Km/h

AI SLAMI ENTO ACÚSTICO
REALIZADO CON 120 DECIBELES AL EXTERIOR
MEDIDA 1.00 x 1.00 m

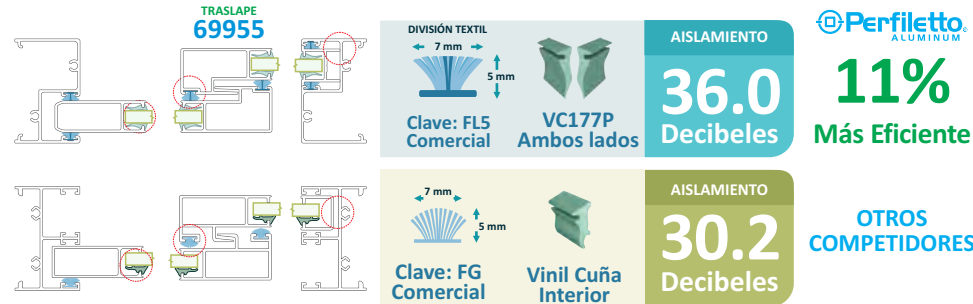

PERMEABILIDAD AL AGUA DURANTE 20 MINUTOS



PERMEABILIDAD AL VIENTO Medida 1.00 x 1.00 m

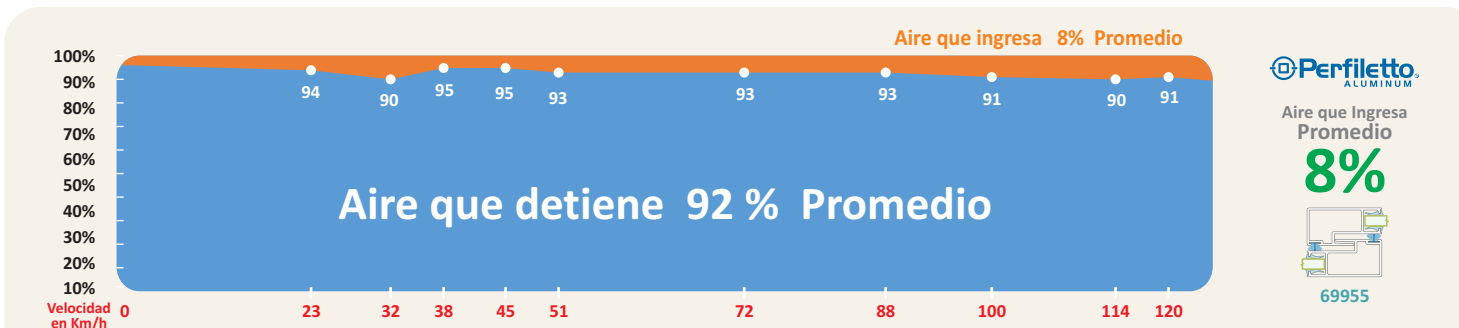

RESISTENCIAS A VIENTOS



Ruptura de Cristal a 110 km/h

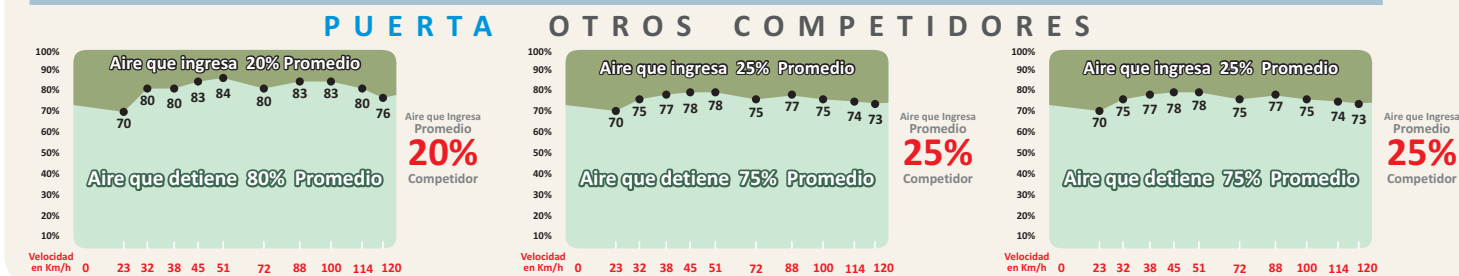

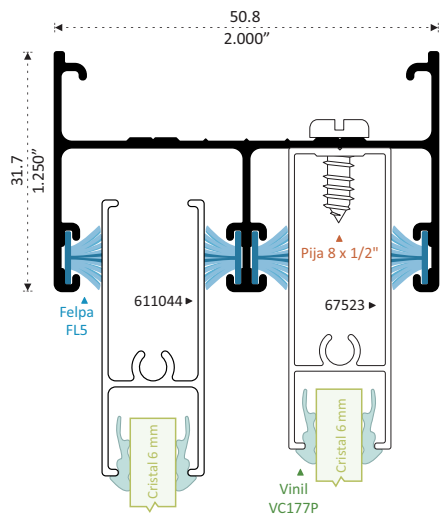

S67518
CONTRAMARCO
Longitud 6.10 m

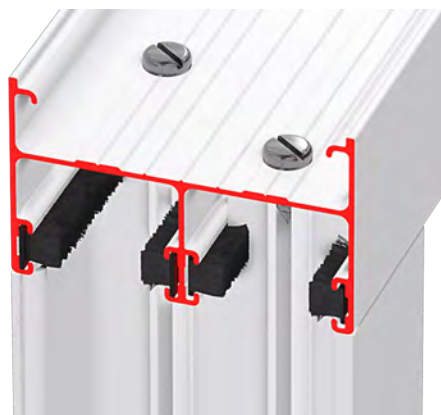

Armado Contramarco
Horizontal Superior sin Venas

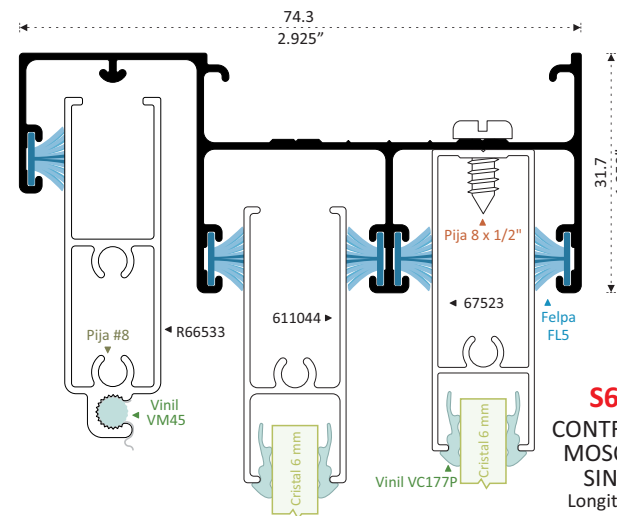

S67819
CONTRAMARCO
MOSQUITERO
SIN VENAS
Longitud 6.10 m

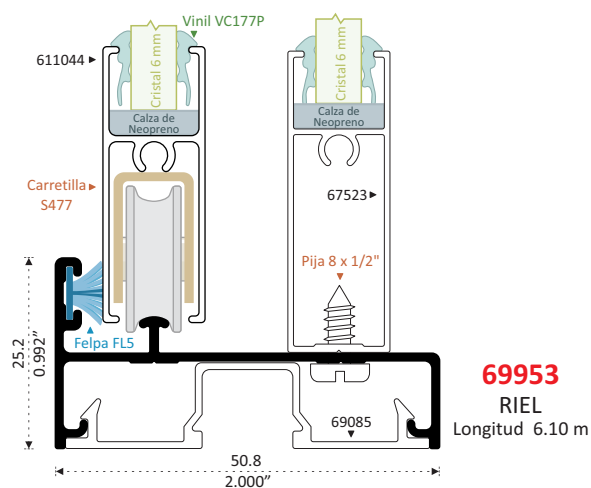

69953
RIEL
Longitud 6.10 m

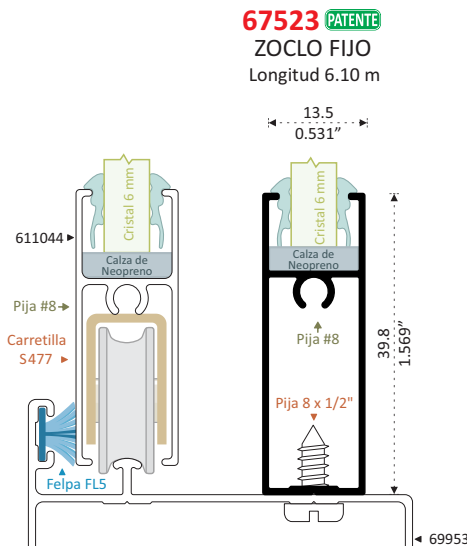

67523 PATENTE
ZOCLO FIJO
Longitud 6.10 m

Fijación Exterior en Hoja Fija:
- Facilita su Instalación.
- Mayor Resistencia a Vientos.

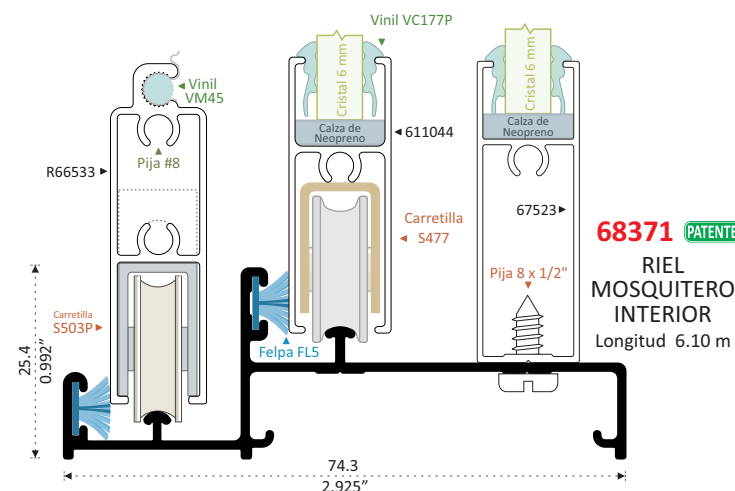

68371 PATENTE
RIEL
MOSQUITERO
INTERIOR
Longitud 6.10 m

611044
ZOCLO Y CABEZAL
Longitud 6.10 m

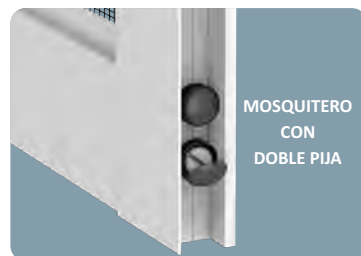
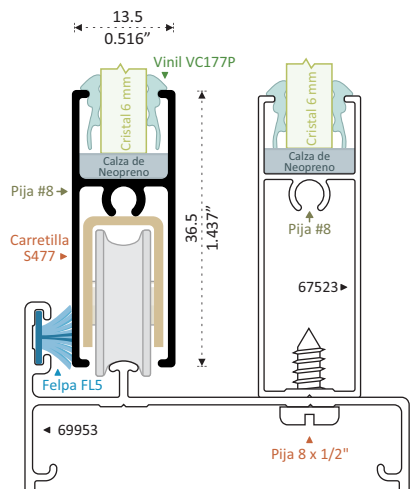

DOBLE PIJA
DANDO RESISTENCIA AL
MOVIMIENTO OSCILATORIO
DEL MOSQUITERO

R66533
MOSQUITERO HORIZONTAL
DOBLE VENA
Longitud 6.10 m

NUEVO

VENTANA
ALTURA MÁXIMA 1.90 m

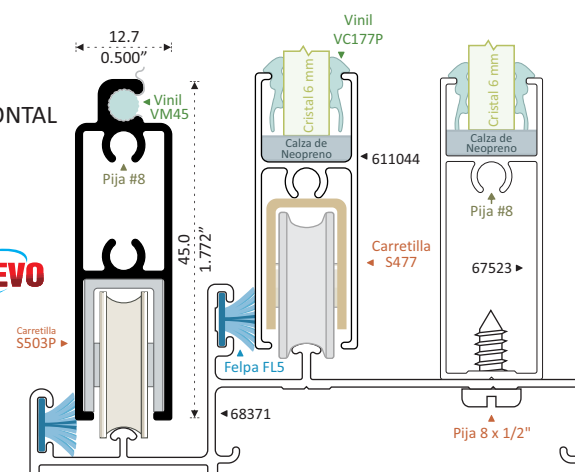

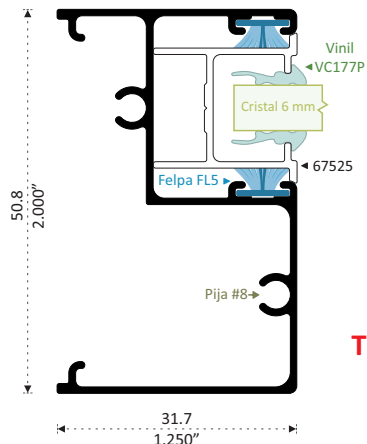

T67518 PATENTE
JAMBA
Longitud 6.10 m

64052
MOLDURA DE FIJACIÓN
Longitud 6.10 m
TF2 10 cm

NUEVO

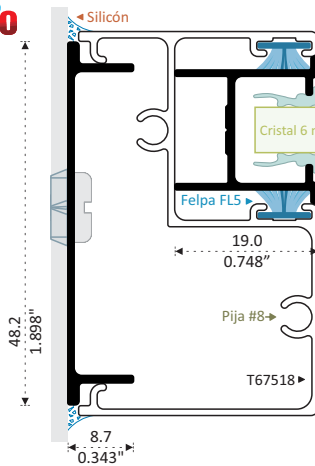

67525
CERCO FIJO
Longitud 6.10 m

69955
TRASLAPE
Longitud 4.60 m
69955-L 6.10 m

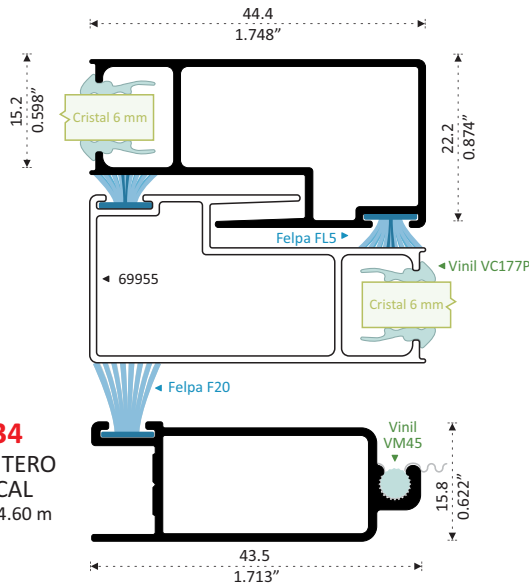

66534
MOSQUITERO VERTICAL
Longitud 4.60 m

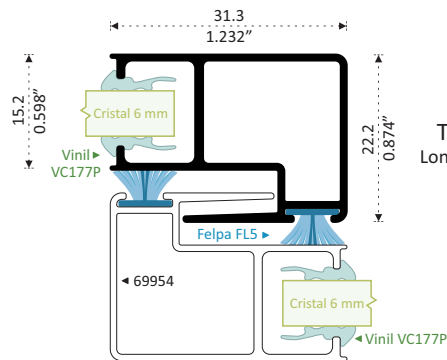

69954
TRASLAPE
Longitud 6.10 m

**Cierre Suave
por su Diseño
Biselado**

67821
CERCO CHAPA
Longitud 4.60 m
67821-L 6.10 m

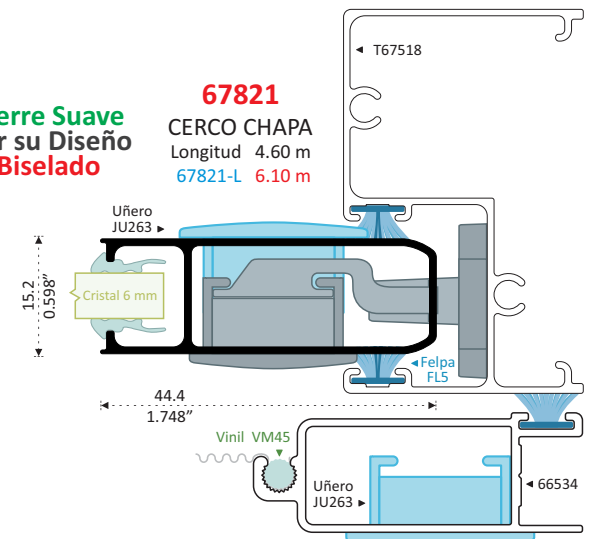

68320
CERCO
Longitud 6.10 m

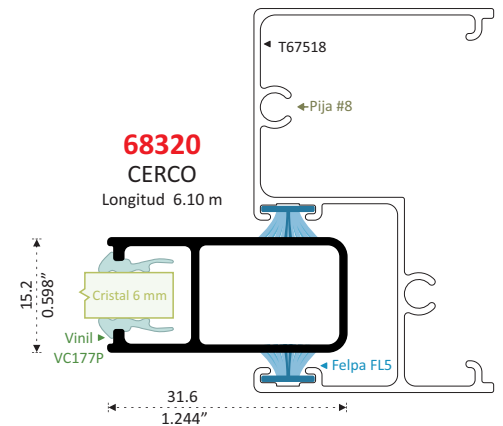

67825
ZOCLO PUERTA
Longitud 6.10 m

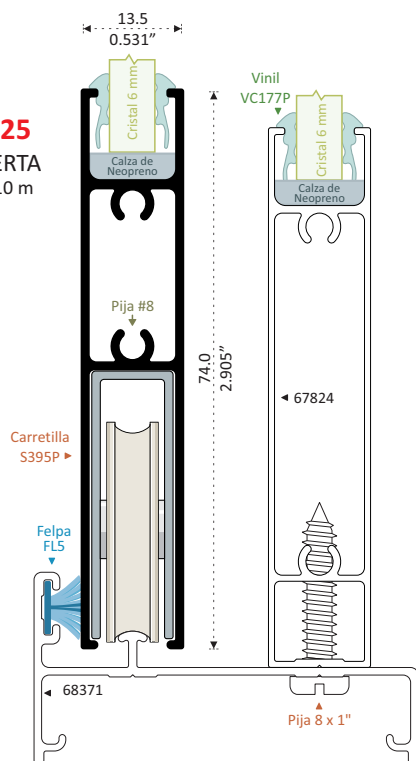

67824 PATENTE
ZOCLO PUERTA FIJO
Longitud 6.10 m

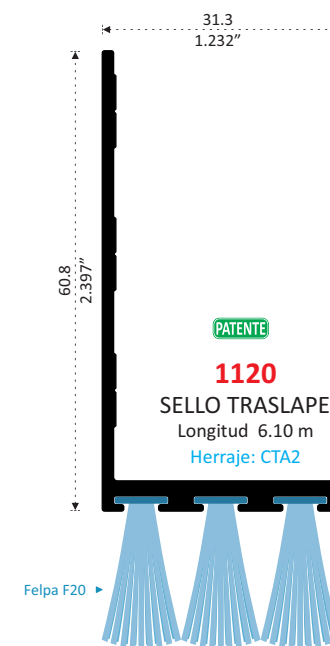
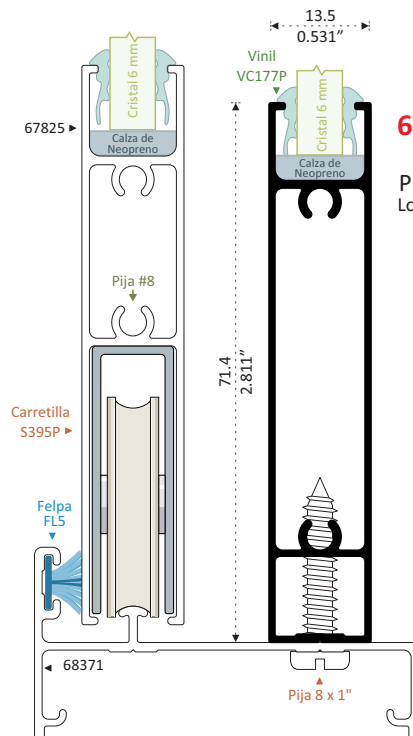

1120
SELLO TRASLAPE
Longitud 6.10 m
Herraje: CTA2

**Colocar en
Traslape
de
Hoja Móvil**

NUEVO

Ventana y Puerta Línea 2"
Cubiertas Traslape
Herraje: CTA2 Par

67518

CONTRAMARCO
Longitud 6.10 m

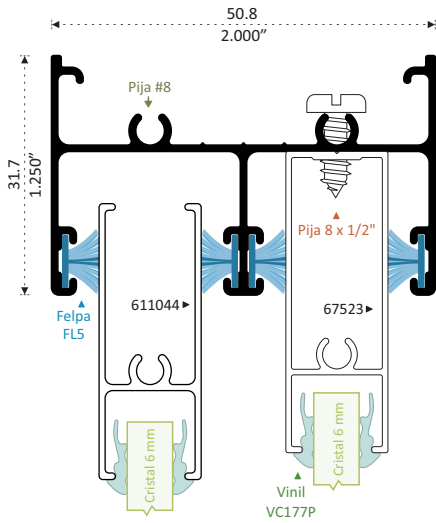

67819 PATENTE

CONTRAMARCO CON MOSQUITERO
Longitud 6.10 m

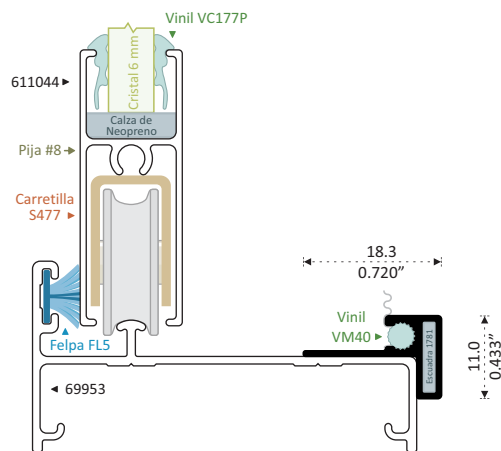
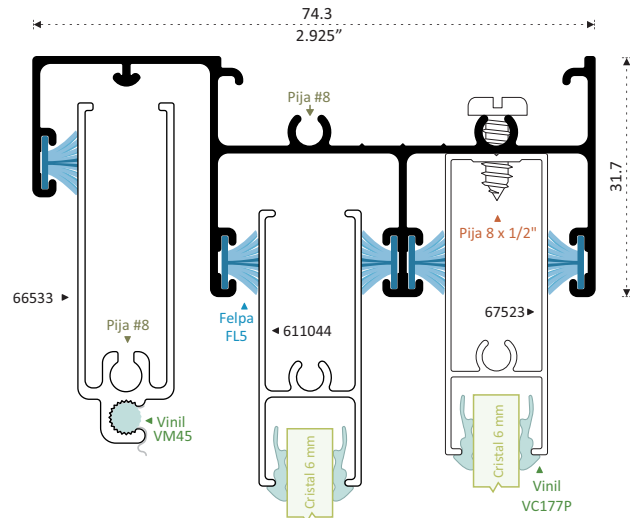

7336
MOSQUITERO FIJO
Longitud 6.10 m

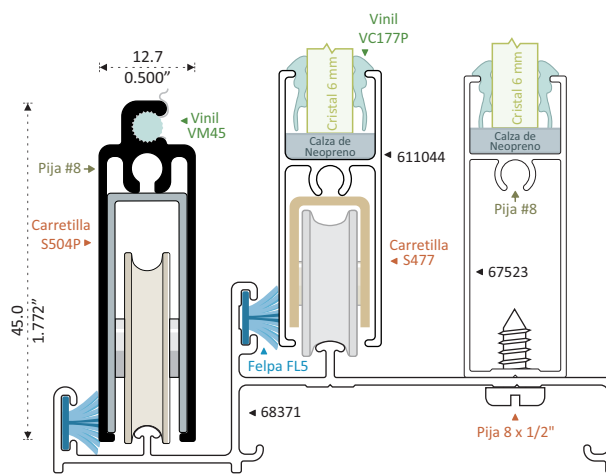

66533
MOSQUITERO HORIZONTAL
VENTANA
Longitud 6.10 m

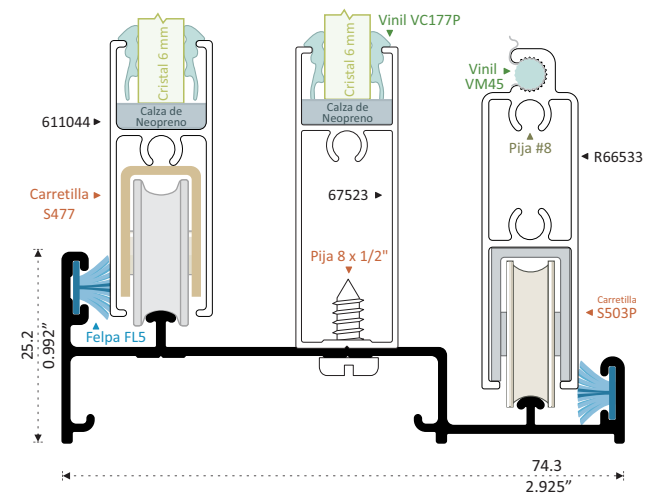

68370 PATENTE
RIEL MOSQUITERO EXTERIOR
Longitud 6.10 m

Entrada de Agua
Con Lluvia y Vientos a Partir de 20 Km/h
En Mosquiteros Corredizos Exteriores

PUERTA BATIENTE SAN LUIS

Convierte un Producto Perfiletto En Extraordinario

Bisagras



1523P



1525P



1524F



1524L

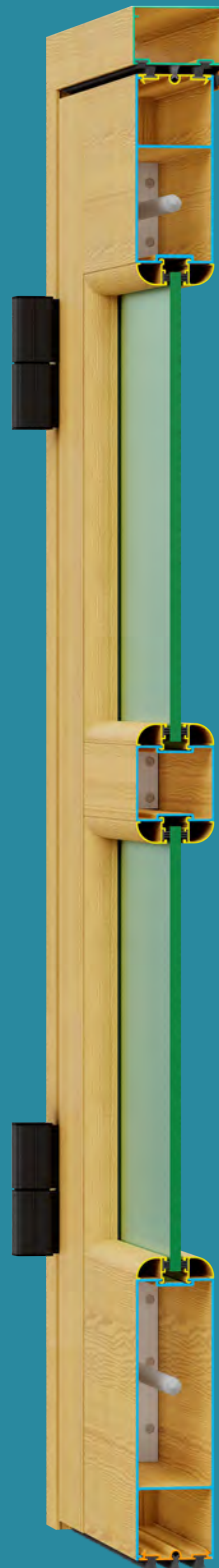

Hermeticidad y Aislamiento
entre Batiente y Cabezal
por 6 Felpas



Espacio para Colocar
Chapas de Acero Inoxidable



Descubre otras Opciones para tu Cancelería



4 Opciones de Junquillos

Marquetería Expuesta



Biselada



Curva

Hermeticidad y Aislamiento
Por su Sello de Hermeticidad
de 3 Felpas

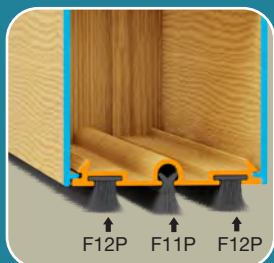

Barra de Armado

Trabaja a la Tensión
y Compresión



Cercos Chapa



Zoclos Cabezal



Adaptador Intermedio
en Zoclo

■ Aislamiento Acústico

Duela-Duela 36.1 Decibles
Cristal-Duela 38.1 Decibles
Cristal-Cristal 40.2 Decibles

■ Permeabilidad
a Viento y Polvo

Con Cerco 79203 Aire que Detiene 75 %
Con Cerco 79204 Aire que Detiene 82 %

■ Resistencia A Vientos 120 Km/h
Sin Deformar el Perfil Cristal de 6 mm /Duela 16617

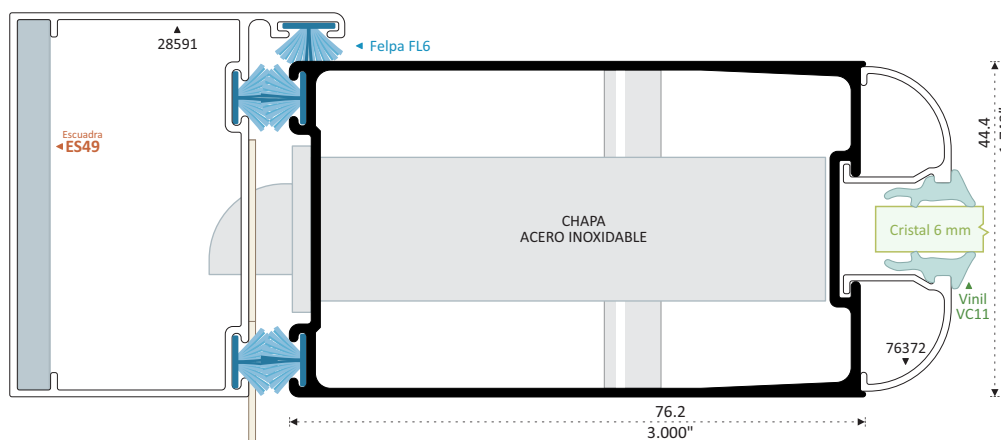
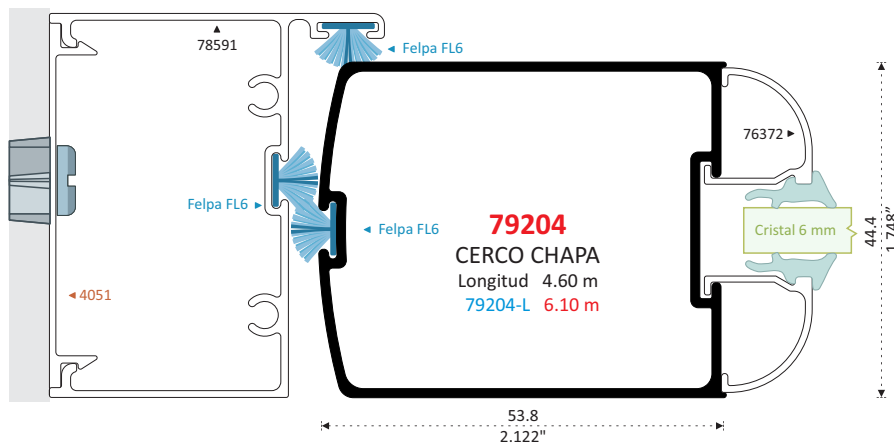
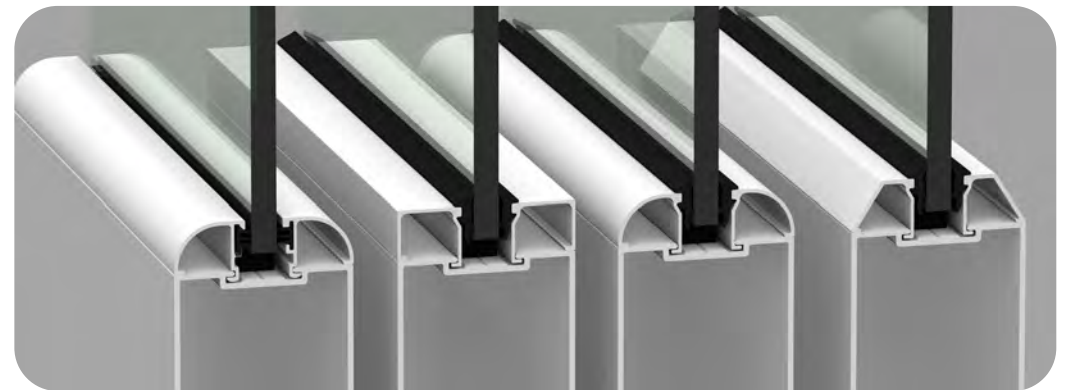
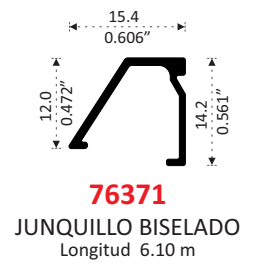
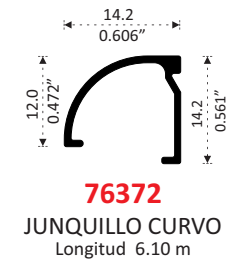
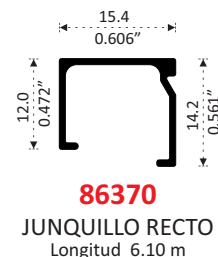
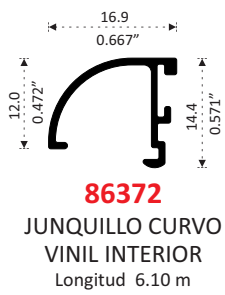
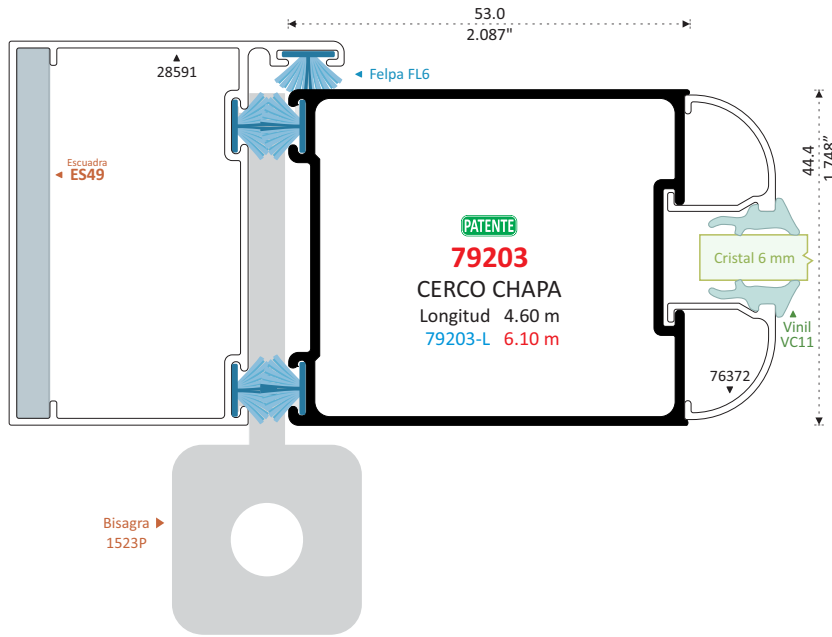

79205
CERCO CHAPA 3"
Longitud 4.60 m
79205-L 6.10 m

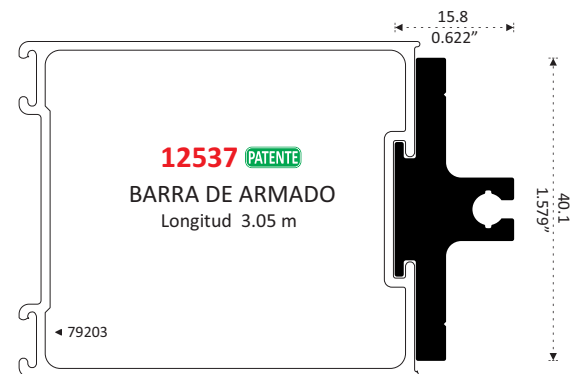

Colocación en Cerco 79203 / 79204 / 79205
En Medidas Mayores a 1 m Se recomienda Colocar Tensor

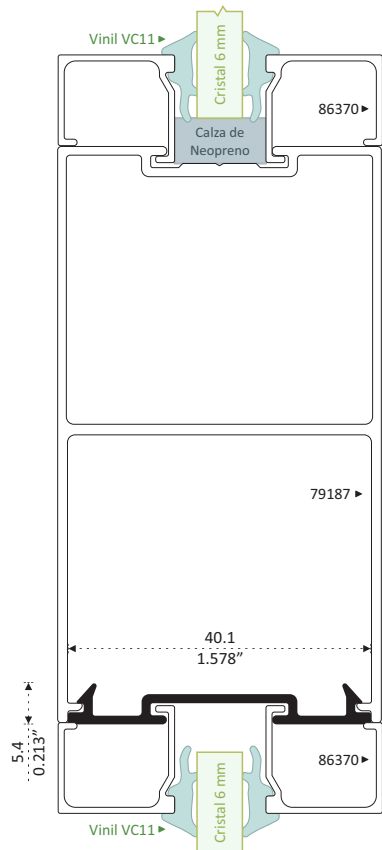

79189
ADAPTADOR
INTERMEDIO
Longitud 6.10 m
ASL 1.00 m

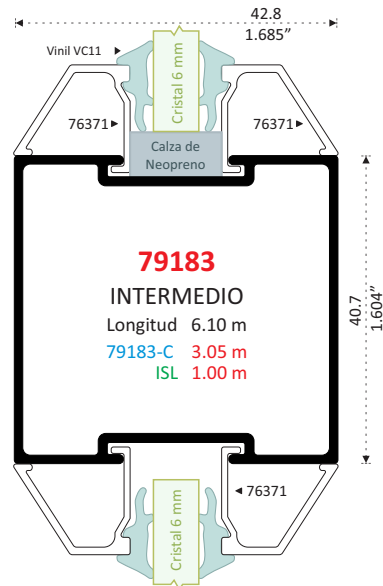

79183
INTERMEDIO
Longitud 6.10 m
79183-C 3.05 m
ISL 1.00 m

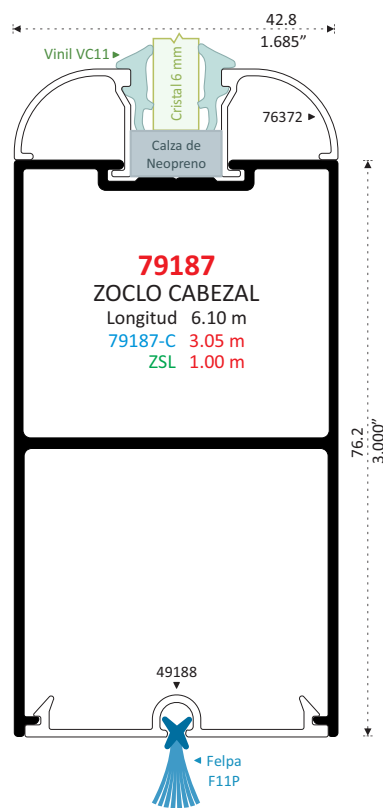

79187
ZOCLO CABEZAL
Longitud 6.10 m
79187-C 3.05 m
ZSL 1.00 m

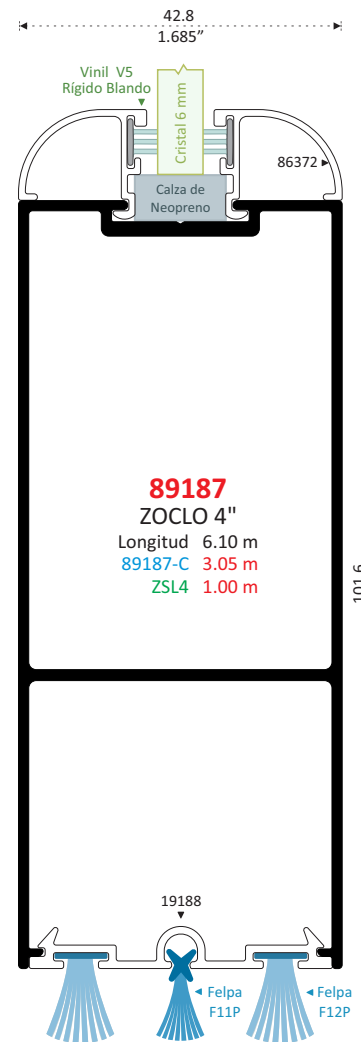
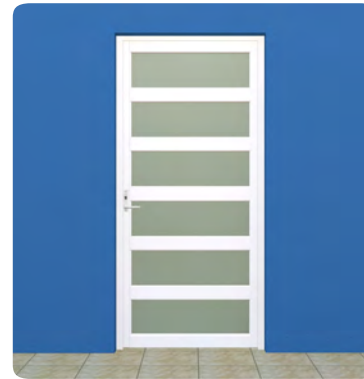

89187
ZOCLO 4"
Longitud 6.10 m
89187-C 3.05 m
ZSL4 1.00 m

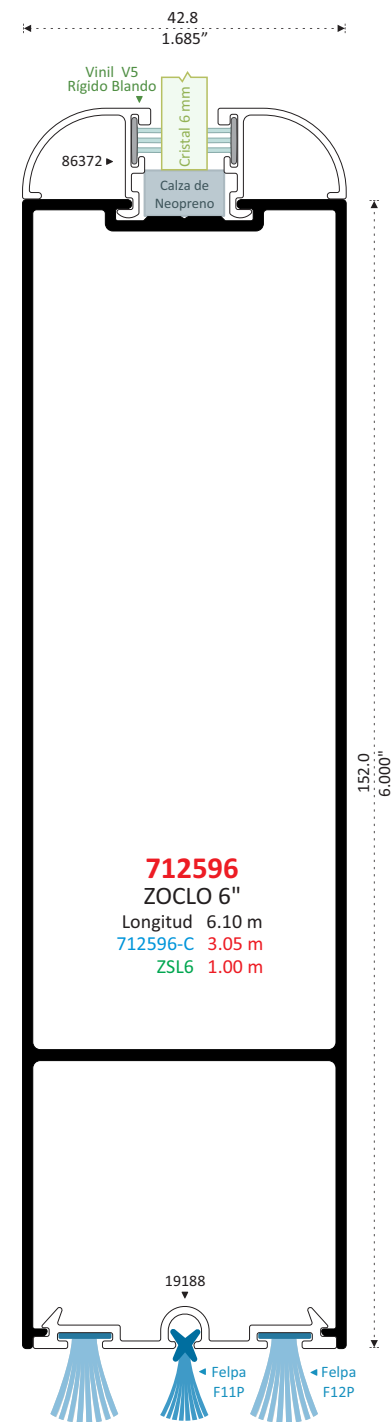

712596
ZOCLO 6"
Longitud 6.10 m
712596-C 3.05 m
ZSL6 1.00 m

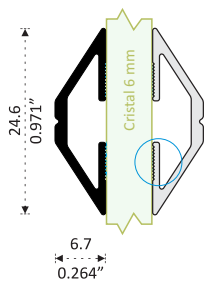
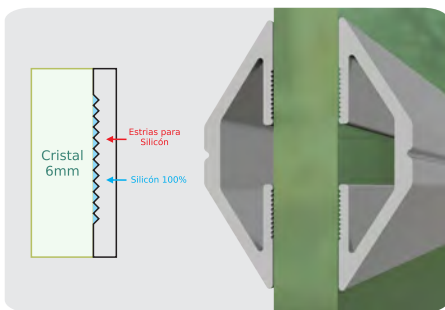

8264
MARQUETERÍA
EXPUESTA
BISELADA
Longitud 6.10 m

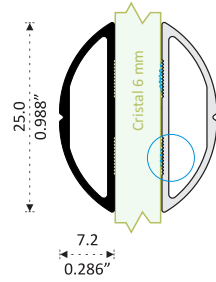

8272
MARQUETERÍA
EXPUESTA
CURVA
Longitud 6.10 m

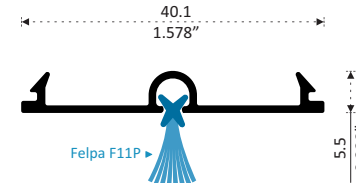

49188
SELLO DE HERMETICIDAD 1 FELPA
Longitud 6.10 m
TH 1.00 m

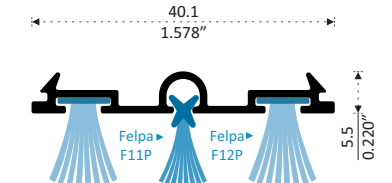

19188
SELLO DE HERMETICIDAD 3 FELPAS
Longitud 6.10 m
19188-C 3.05 m
SHT 1.00 m

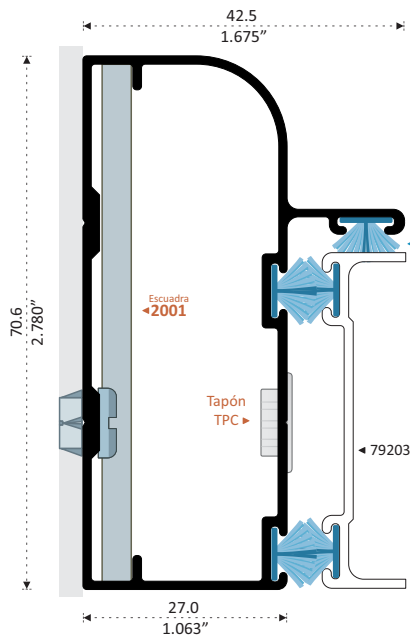

22757
BATIENTE COLONIAL
Longitud 6.10 m



Bisagra 1523P

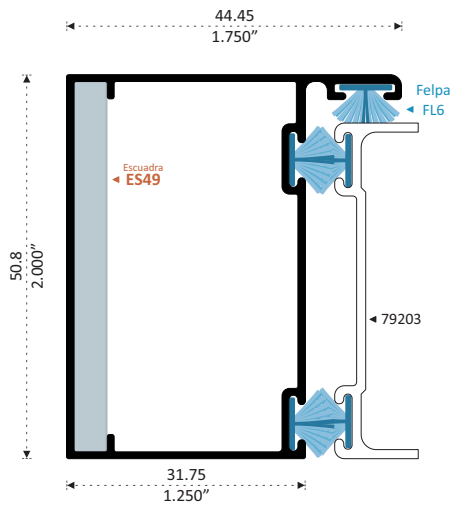

28591
BATIENTE
Longitud 6.10 m



Bisagra 1523P

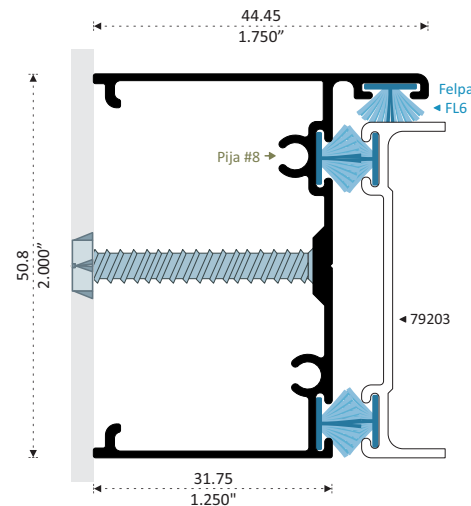

58591
BATIENTE 2"
Longitud 6.10 m



Bisagra 1523P

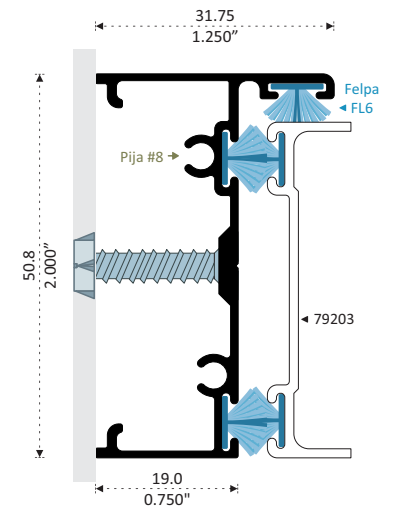

55844
BATIENTE 2"
Longitud 6.10 m



Bisagra 1525P



Bisagra 1524L

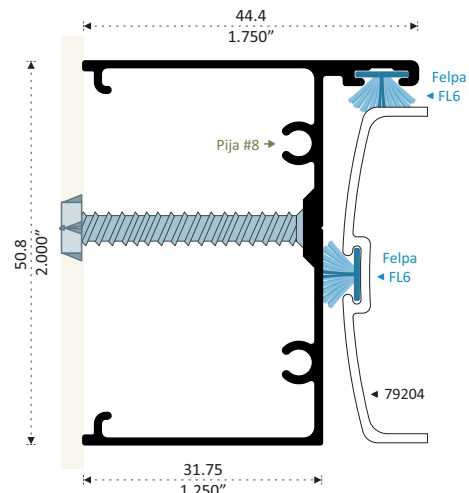

48591
BATIENTE 2"
Longitud 6.10 m

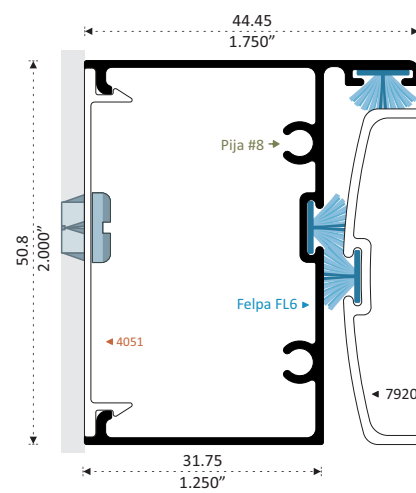

78591 PATENTE
BATIENTE 2"
Longitud 6.10 m

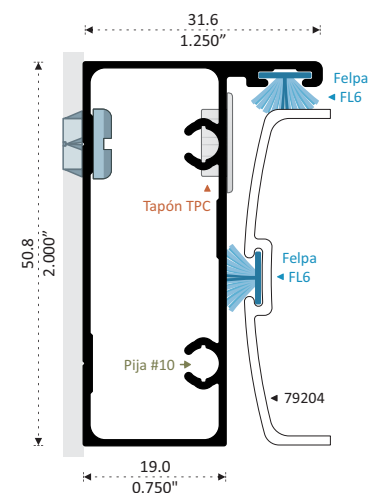

45844
BATIENTE
Longitud 6.10 m

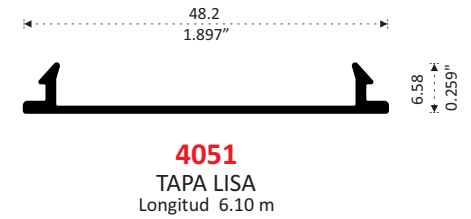
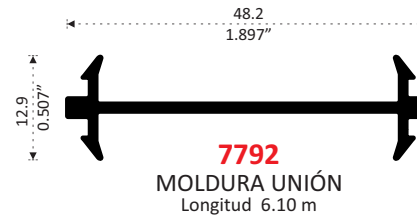
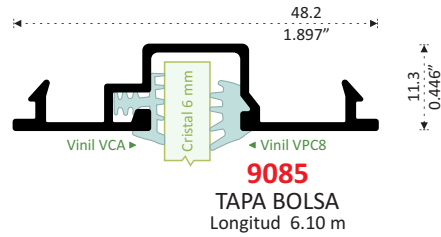
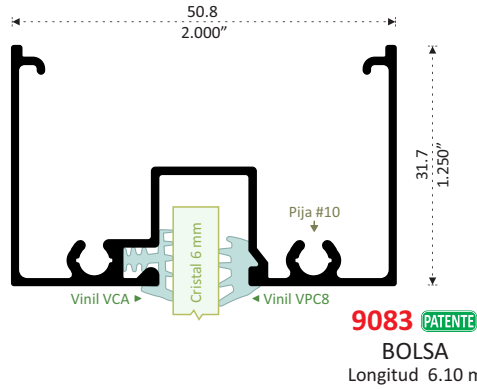

Perfil Especial para Rolar

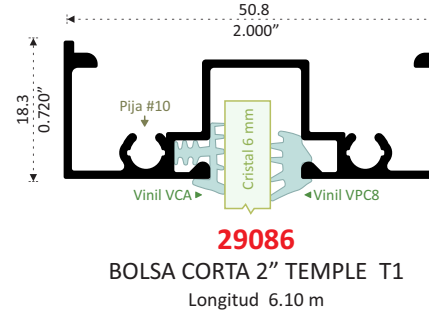

Es Alterado El Temple T1,
durante el Proceso de
Pintura Electrostatica

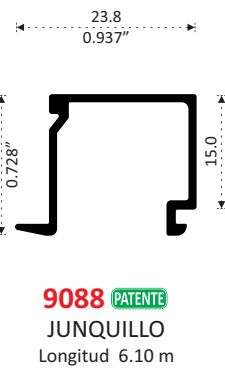
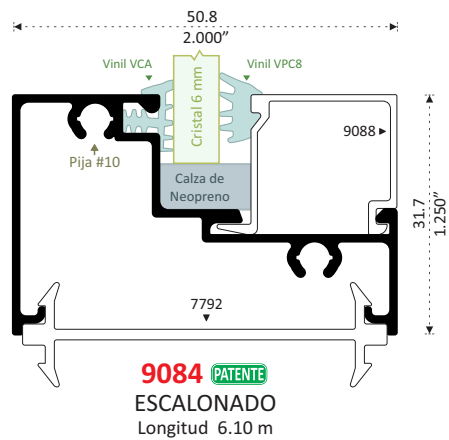

ESCALONADO Y JUNQUILLO
A PRESIÓN

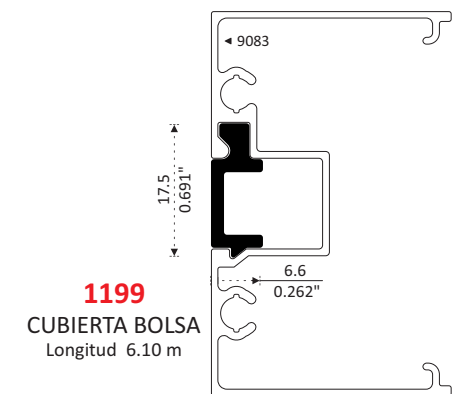
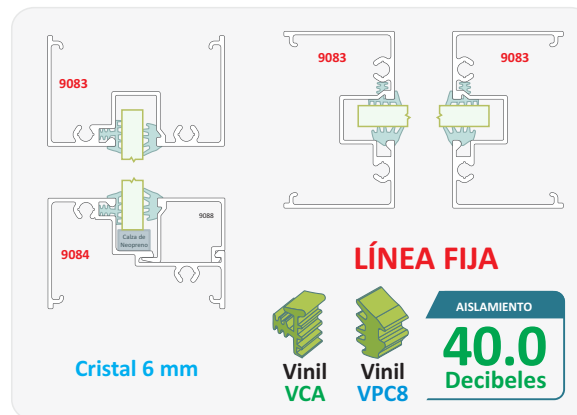
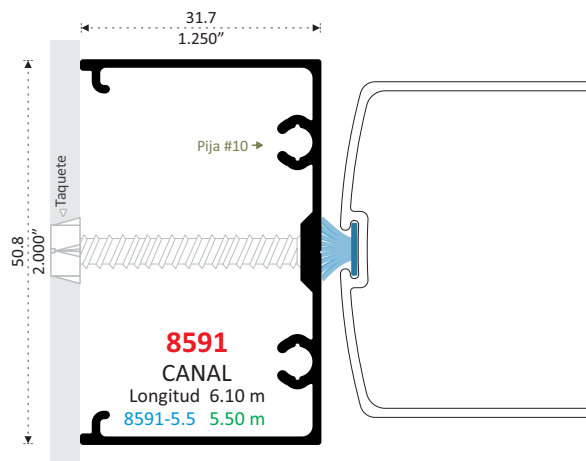
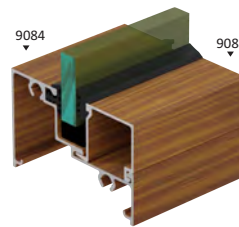

ESQUINEROS

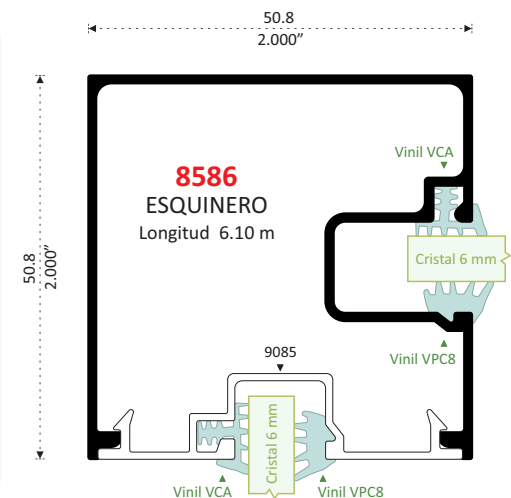
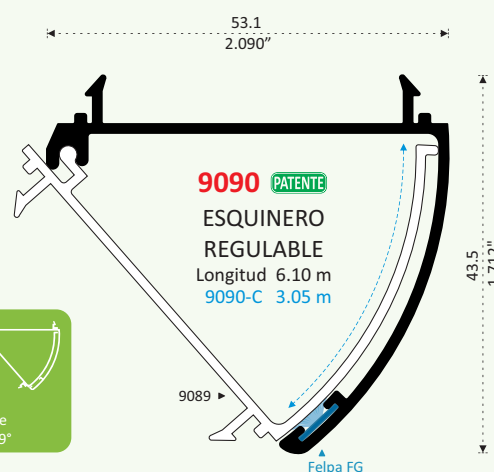
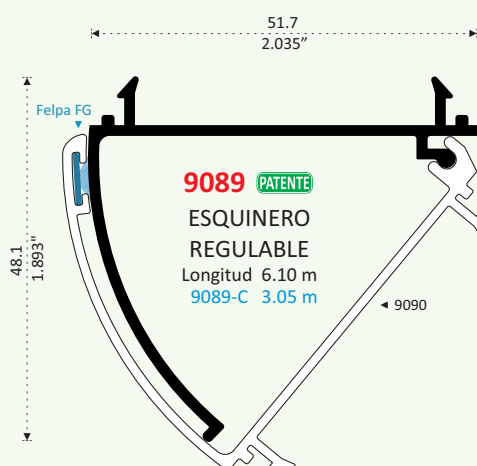

LÍNEA 2" COMERCIAL HERMÉTICA

Convierte un Producto Perfiletto En Extraordinario

MAYORES GANANCIAS
utilizando contramarco sin venas



Armado Horizontal Superior



Más Acercamiento de Felpas logrando **MAYOR HERMETICIDAD**



MAYOR ACERCAMIENTO de Felpa con Zoclo

Sellado entre Riel y Jambas con Juntas de Estanqueidad

Riel con Inclinación

Evite Filtraciones de Agua y Humedades a Muros

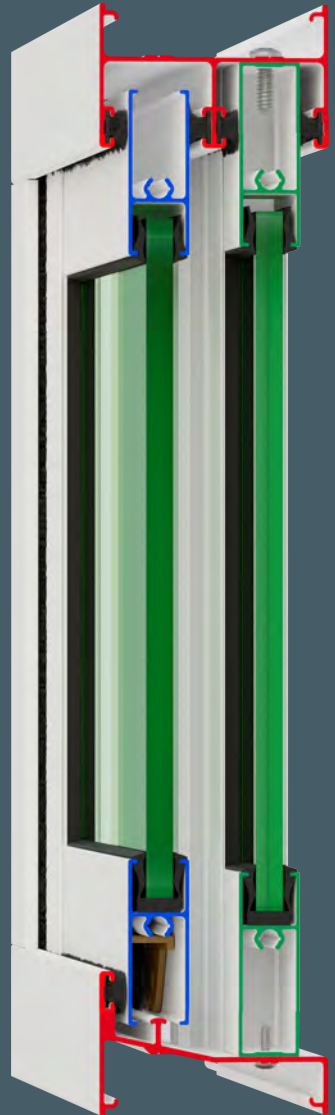

Atornillado de hoja fija

MÁS RÁPIDO

Atornille una sola vez los Traslapes, Acristale en Mesa Hojas Fija y Corrediza



Colocación Rápida de Hoja Corrediza y Hoja Fija Con Atornillado por el Exterior, en Zoclo y Cabezal Pijas sin Contacto con el Cristal

Zoclo de Hoja Fija con **Mayor Resistencia** ante Ráfagas de Viento



ATORNILLAR POR FUERA

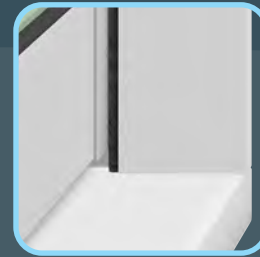

Vista Distinguida y Más Económica

Las Felpas y el Vinil pezuña **Aumentan** el Aislamiento Acústico y Hermeticidad a viento y polvo



Instalado da **Apariencia de un Perfil Integrado** al Contramarco

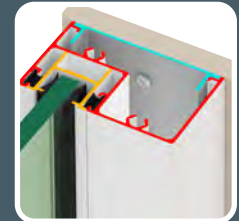

Ofrece la Experiencia de un Cierre Suave y Silencioso

Por Cerco con Esquinas Curvas y Contacto de Felpas al 100%

Fijación Invisible con Moldura de Fijación a Muro



Cubiertas Traslapes

Maximiza la Hermeticidad a Viento y Polvo, entre Traslapes, Contramarco y Riel hasta un **85%**

Descubre otras Opciones para tu Cancelería



Adaptador Cierre al Centro 2 Hojas

Excelente vista por su Cierre al Centro

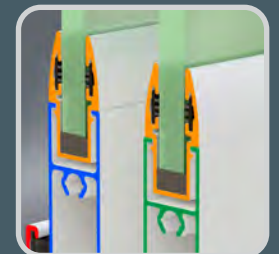

Adaptador Curvo

Mejor Vista por sus vinilos ocultos

Optimiza tus Compras Perfiles con Diferentes Longitudes

■ Aislamiento Acústico 9955 **37.3 Decibles**

■ Permeabilidad a Viento y Polvo 9955 **Aire que Detiene 93 %**

■ Resistencia A Vientos Sin Deformar el Perfil Ventana **120 Km/h**
Puerta **120 Km/h**

AI SLAM IENTO ACÚSTICO
 REALIZADO CON 120 DECIBELES AL EXTERIOR
 MEDIDA 1.00 x 1.00 m

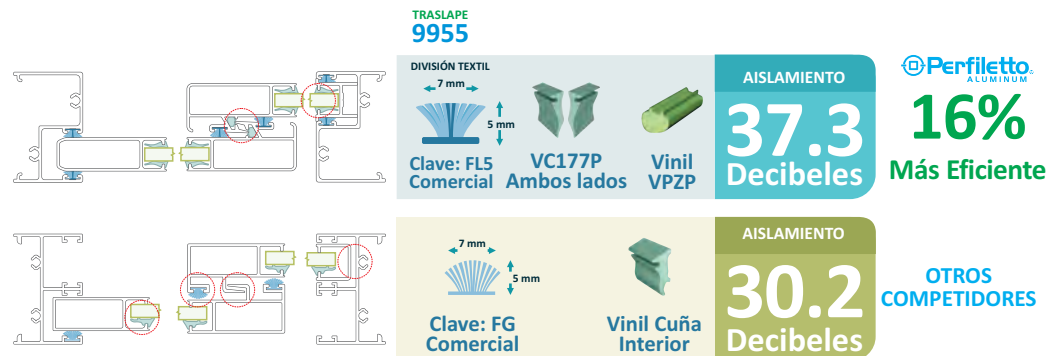

PERMEABILIDAD AL AGUA DURANTE 20 MINUTOS



PERMEABILIDAD AL VIENTO Medida 1.00 x 1.00 m

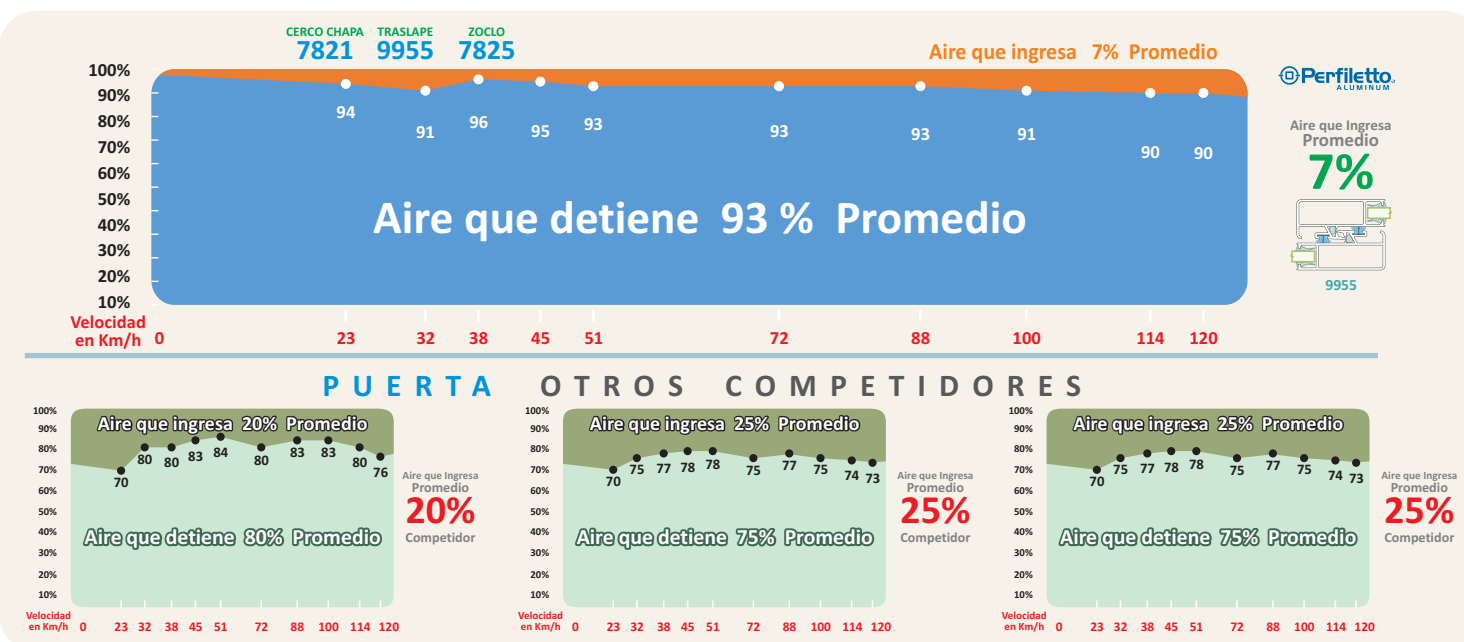

RESISTENCIAS A VIENTOS



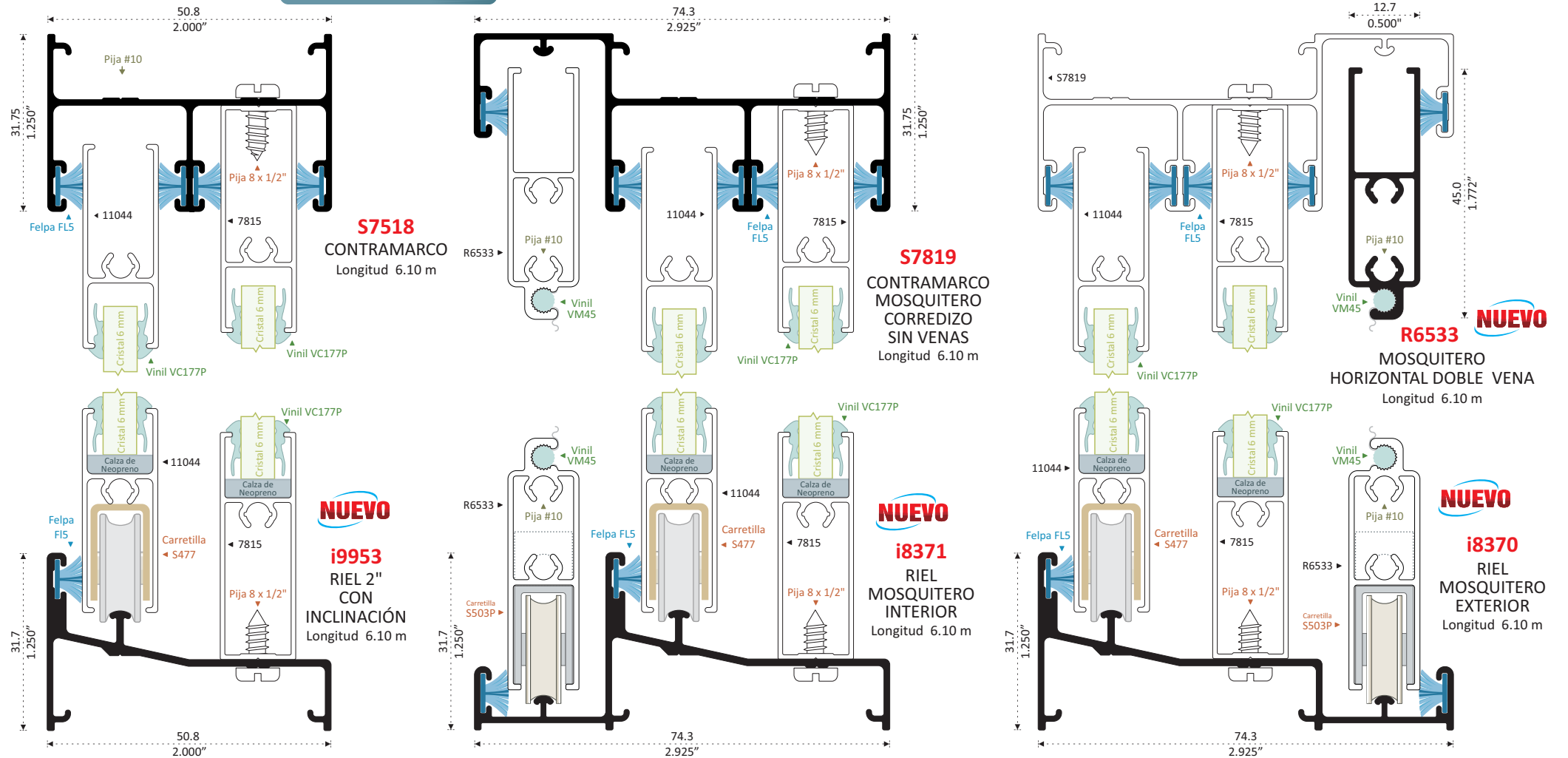

INCLINACIÓN EN RIELES MEJORA LA SALIDA DE AGUA

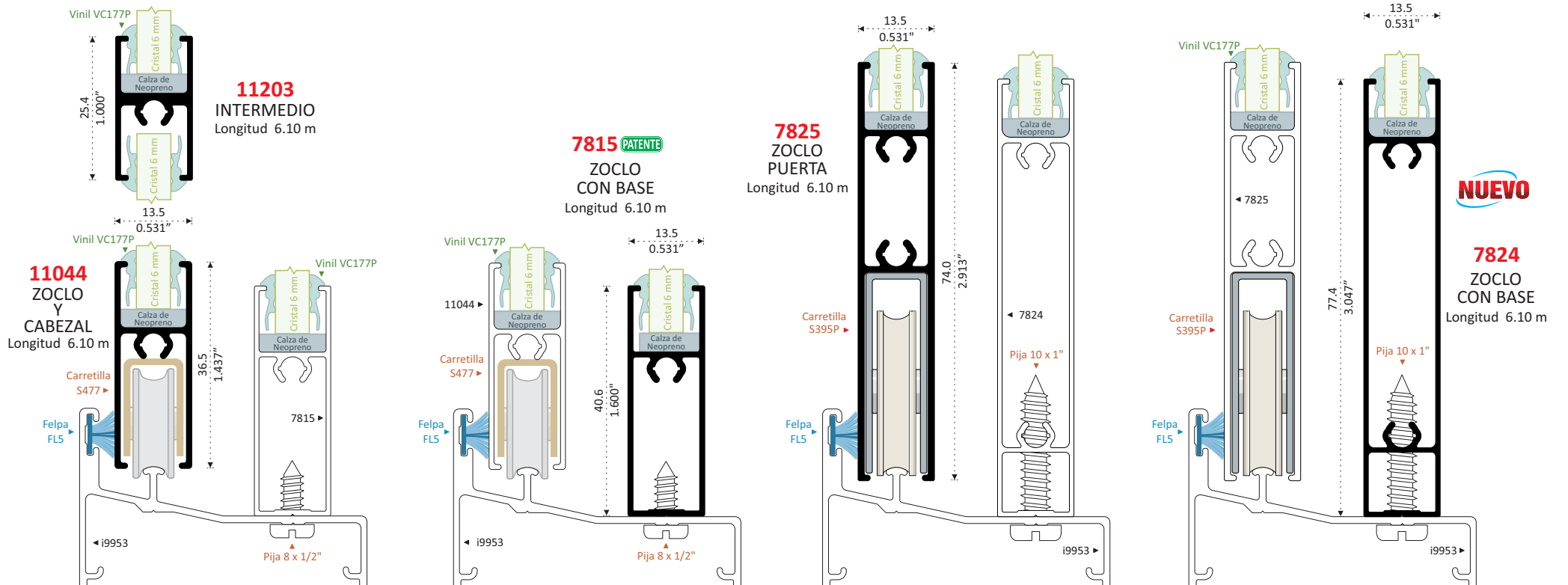

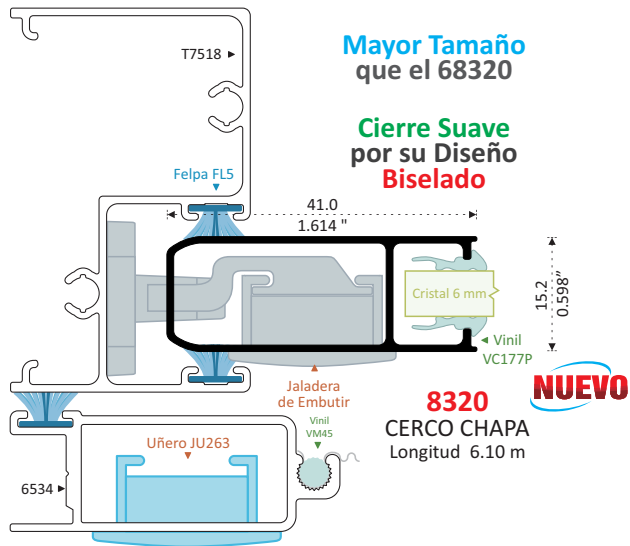

9954 PATENTE
TRASLAPE
Longitud 6.10 m

MAYOR HERMETICIDAD EN TRASLAPES POR SU VINIL VPZP

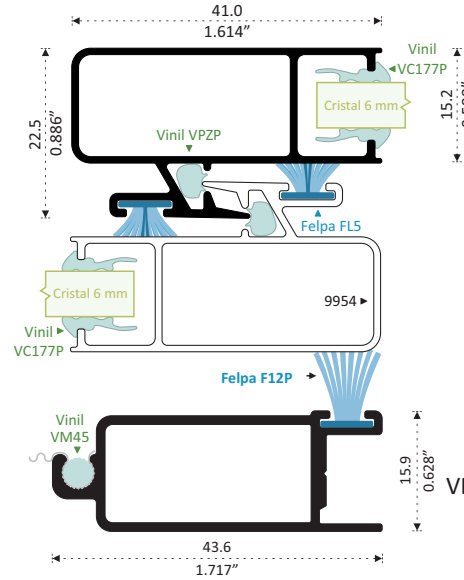

6534
MOSQUITERO VERTICAL VENTANA
Longitud 4.60 m
6534-L 6.10 m

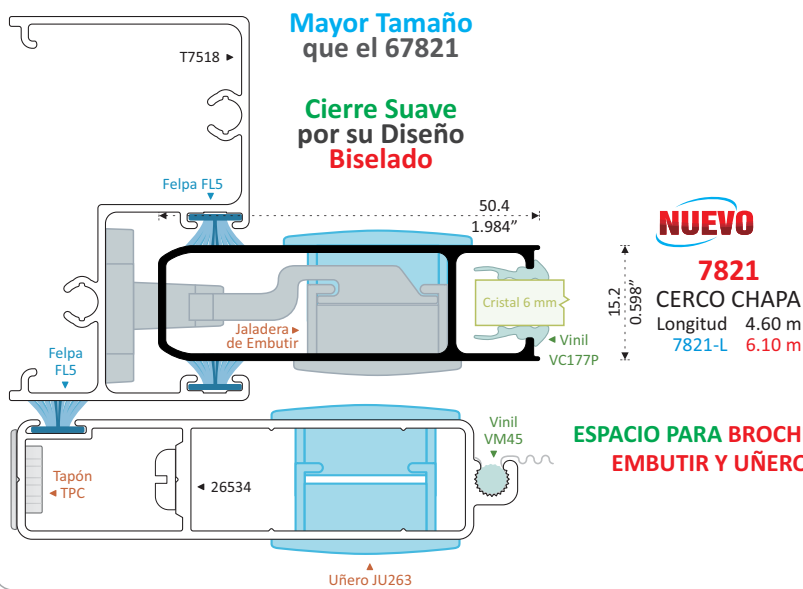
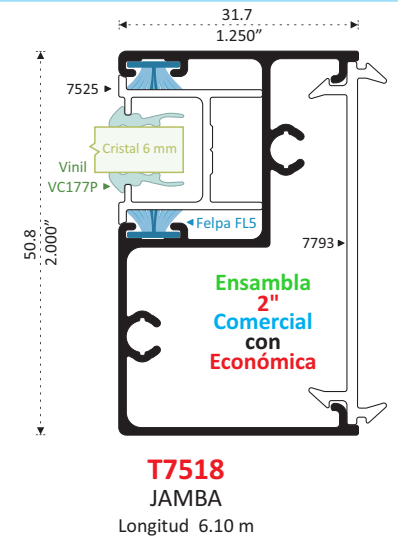

9955 PATENTE
TRASLAPE
Longitud 4.60 m
9955-L 6.10 m

ESPACIO PARA BROCHE DE EMBUTIR Y UÑERO

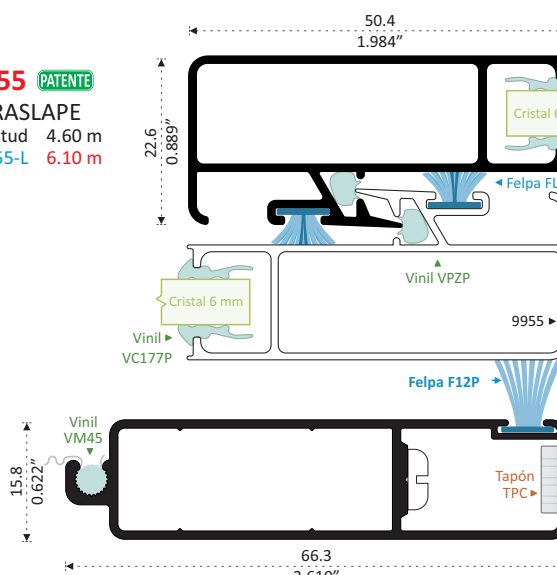

26534 PATENTE
MOSQUITERO VERTICAL PUERTA
Longitud 6.10 m

7525 PATENTE
CERCO FIJO
Longitud 6.10 m

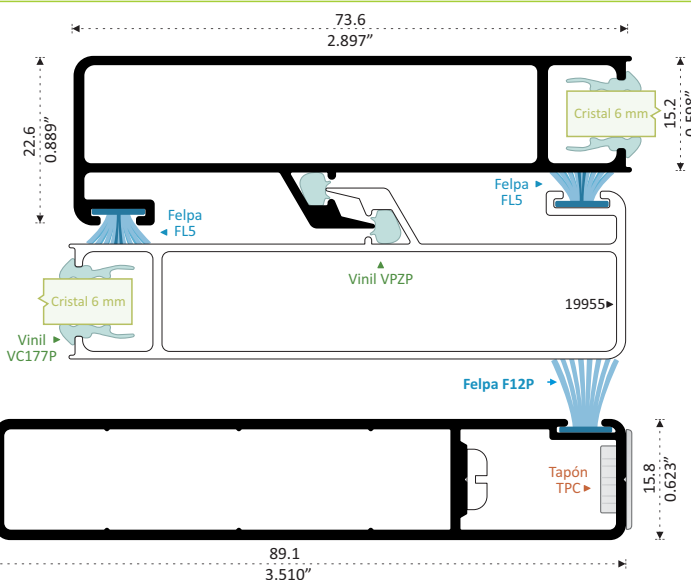
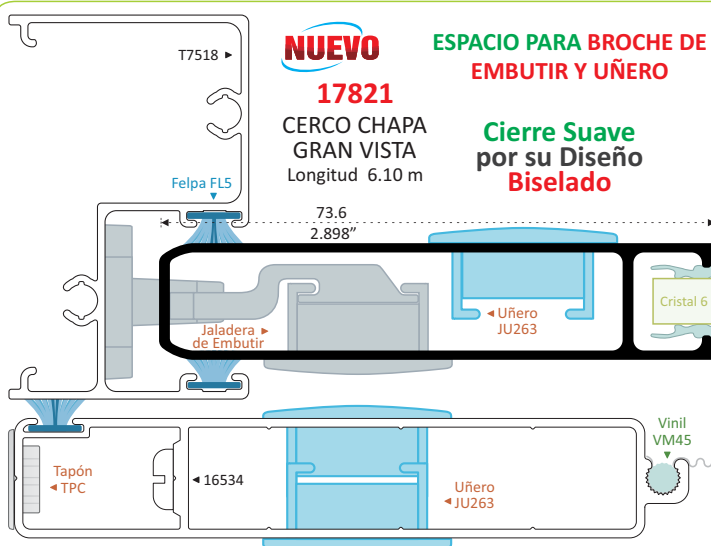
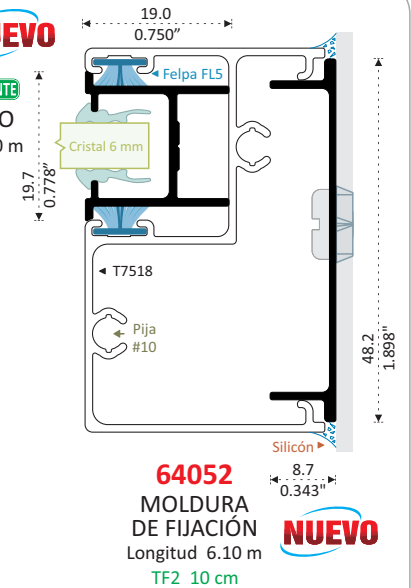

19955 PATENTE
TRASLAPE
Longitud 6.10 m

16534 PATENTE
MOSQUITERO VERTICAL GRAN VISTA
Longitud 6.10 m

Colocar en Traslape de Hoja Móvil

CTA2
Traslape

1.27 cm
6 cm
3 cm

NUEVO

Ventana y Puerta Línea 2" Cubiertas Traslape

Herraje CTA2 Par

MOSQUITEROS

CORREDIZOS HORIZONTALES

PUERTA GRAN VISTA

ALTURA MÁXIMA 2.80 m

DOBLE PIJA
DANDO RESISTENCIA AL
MOVIMIENTO OSCILATORIO
DEL MOSQUITERO

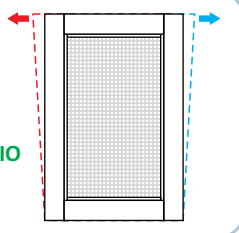

VENTANA
ALTURA MÁXIMA 2.10 m

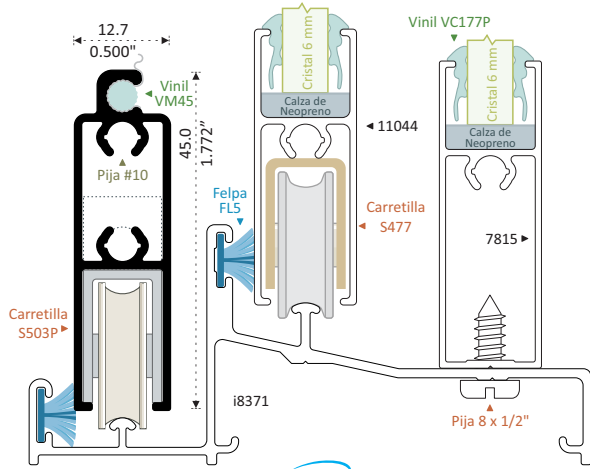

R6533
MOSQUITERO
HORIZONTAL DOBLE VENA
Longitud 6.10 m

NUEVO

VENTANA
ALTURA MÁXIMA 1.30 m

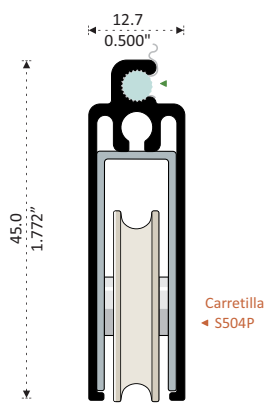

6533 PATENTE
MOSQUITERO
HORIZONTAL VENTANA
Longitud 6.10 m

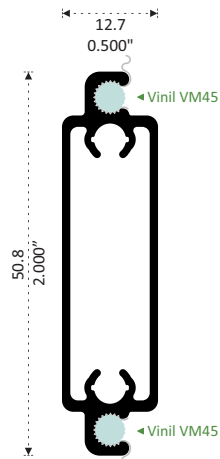

7101
INTERMEDIO
MOSQUITERO
Longitud 6.10 m

PUERTA
ALTURA MÁXIMA 2.40 m

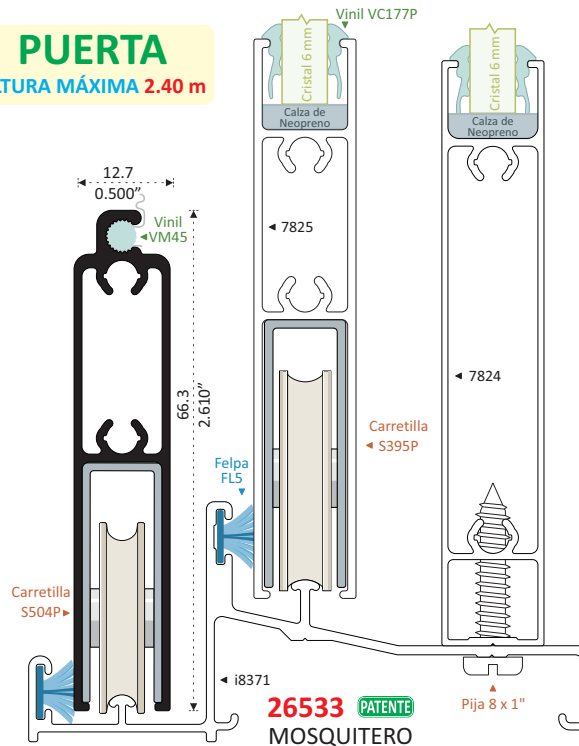

26533 PATENTE
MOSQUITERO
HORIZONTAL PUERTA
Longitud 6.10 m

7816 PATENTE
CABEZAL
ADAPTADOR
MOSQUITERO
Longitud 6.10 m

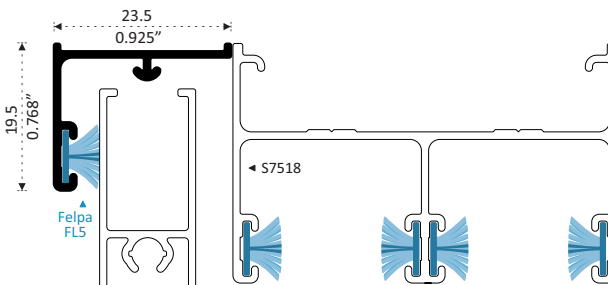

7817 PATENTE
RIEL ADAPTADOR
MOSQUITERO
Longitud 6.10 m

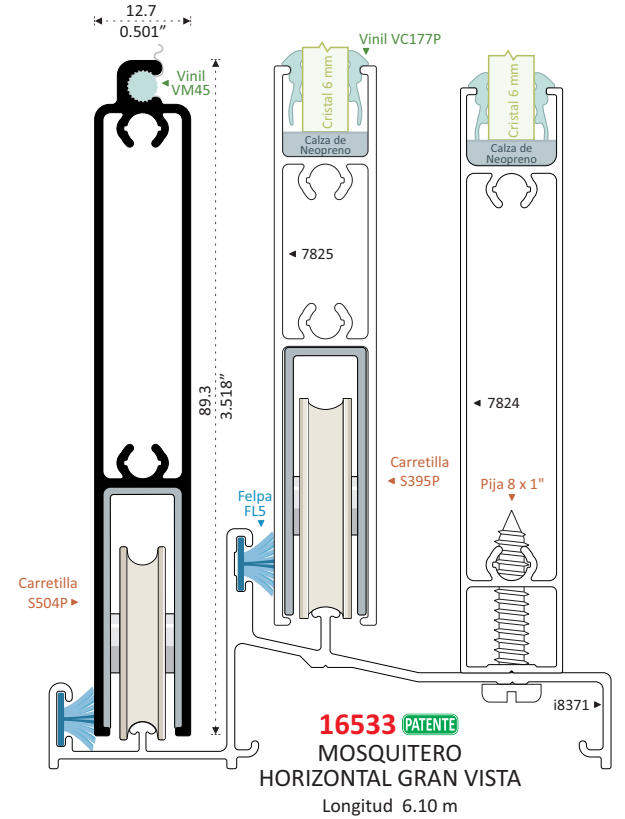
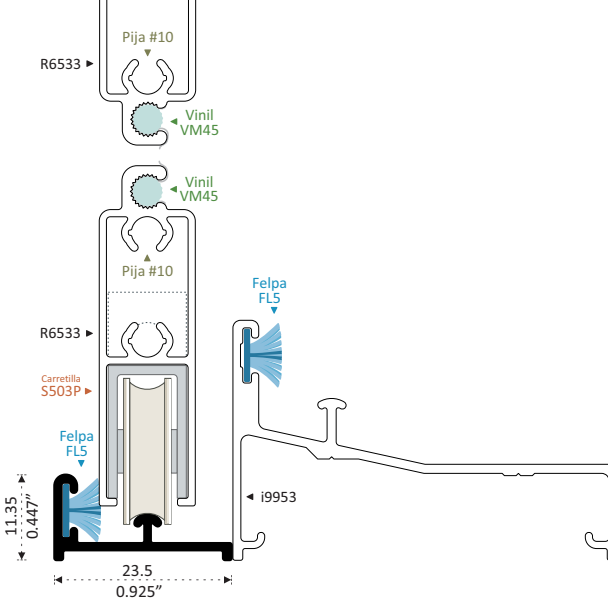

16533 PATENTE
MOSQUITERO
HORIZONTAL GRAN VISTA
Longitud 6.10 m

EN LLUVIAS HASTA 120 Km/h
SIN FILTRACIONES
CON JUNTA DE ESTANQUEIDAD



7336
MOSQUITERO FIJO
Longitud 6.10 m

Entrada de Agua a Partir de 20 Km/h
Con Mosquiteros Fijos 7333 y 67333

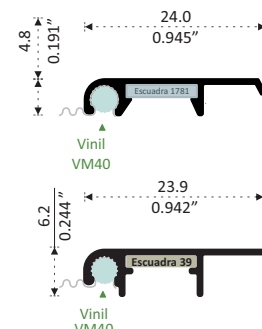

7333
MOSQUITERO FIJO
Longitud 6.10 m

67333 PATENTE
MOSQUITERO FIJO
Longitud 6.10 m

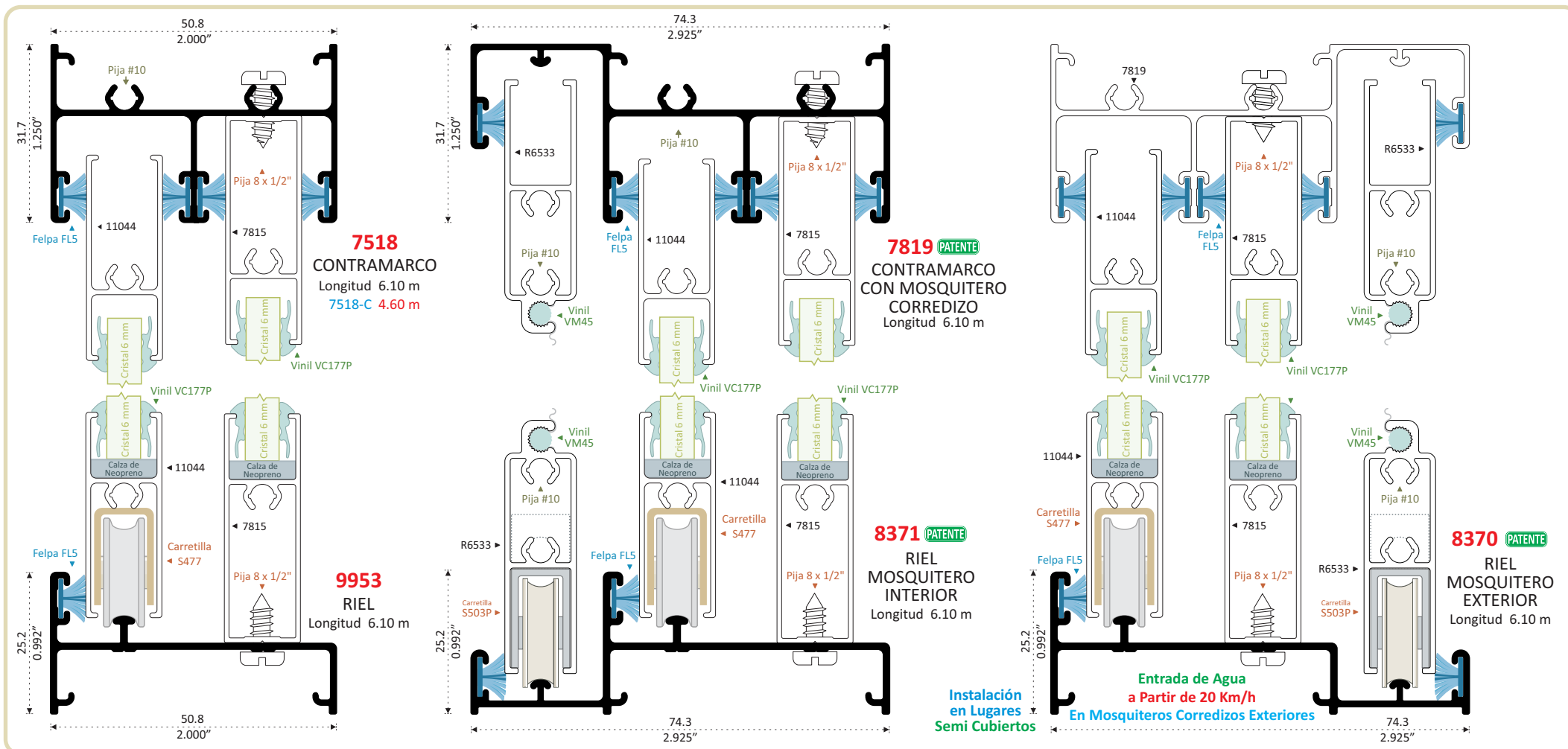

COMPLEMENTOS

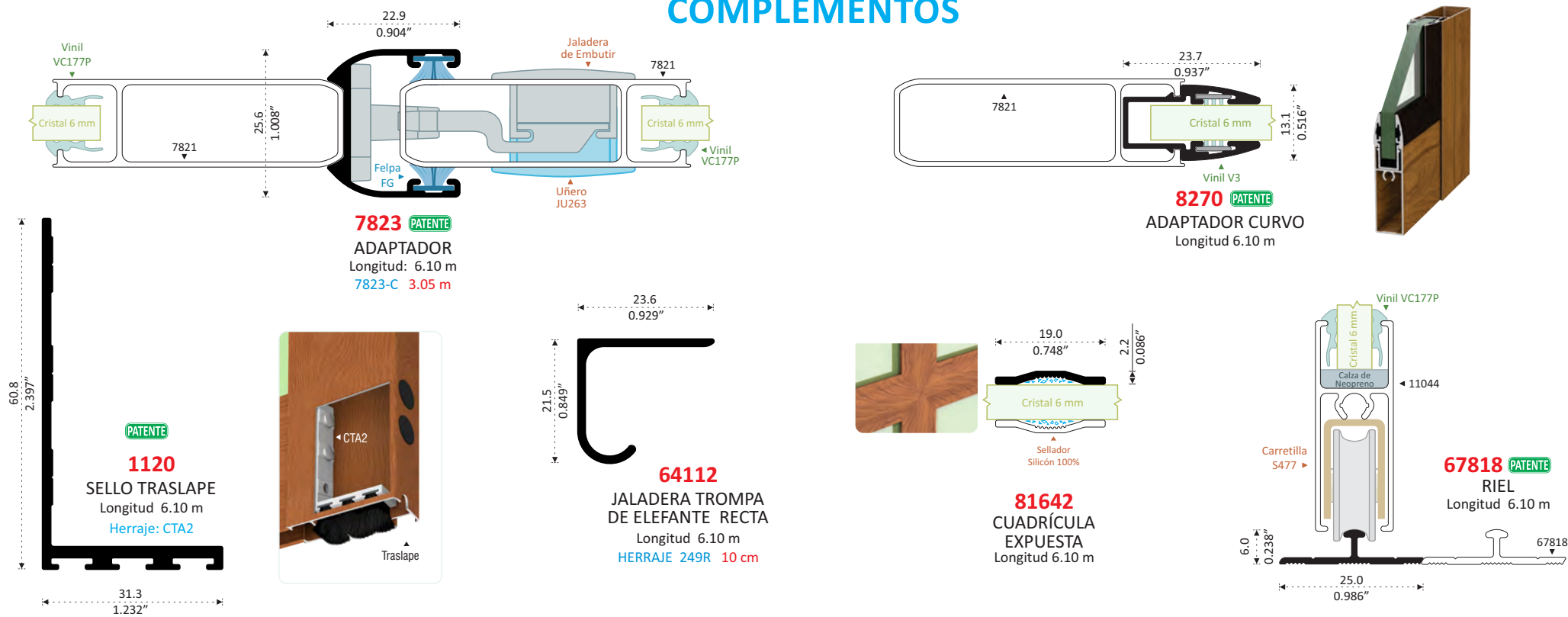

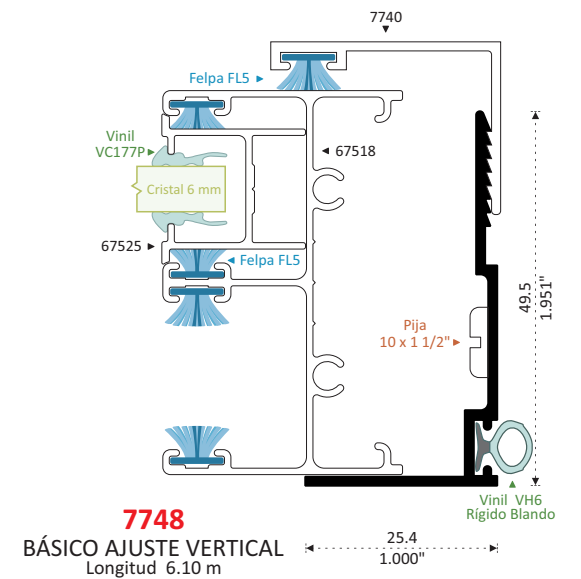
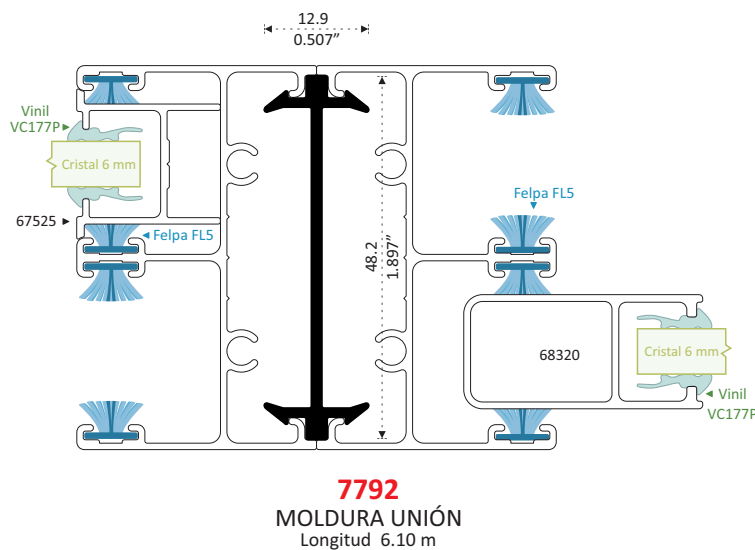
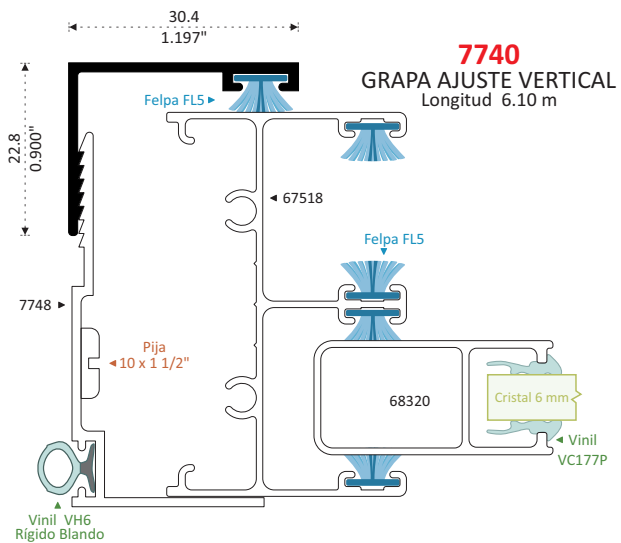
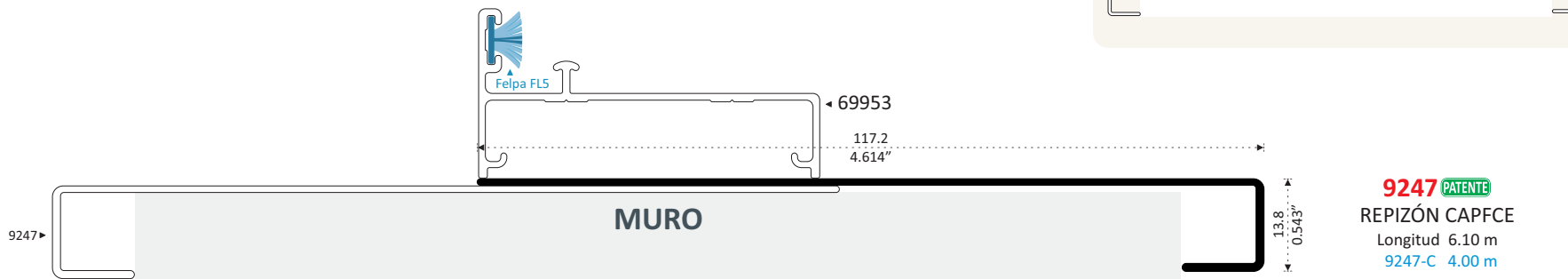
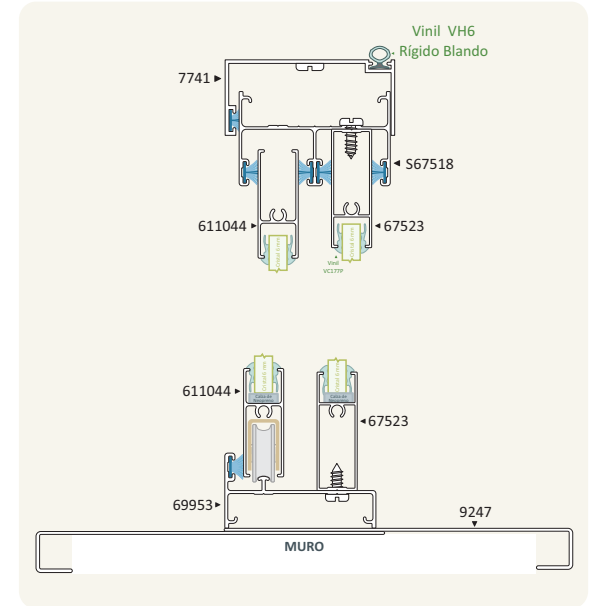
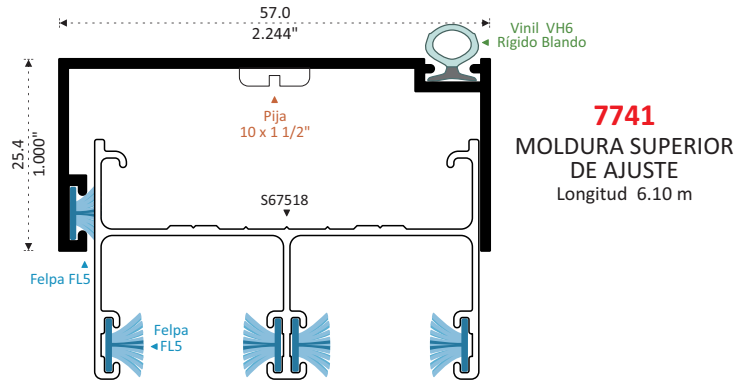

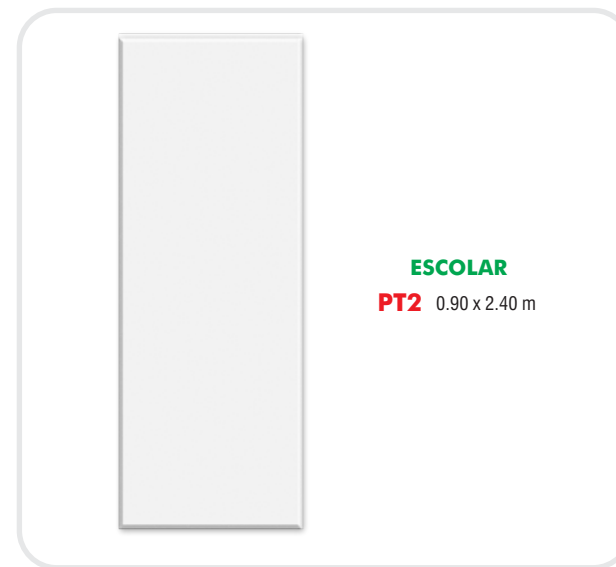
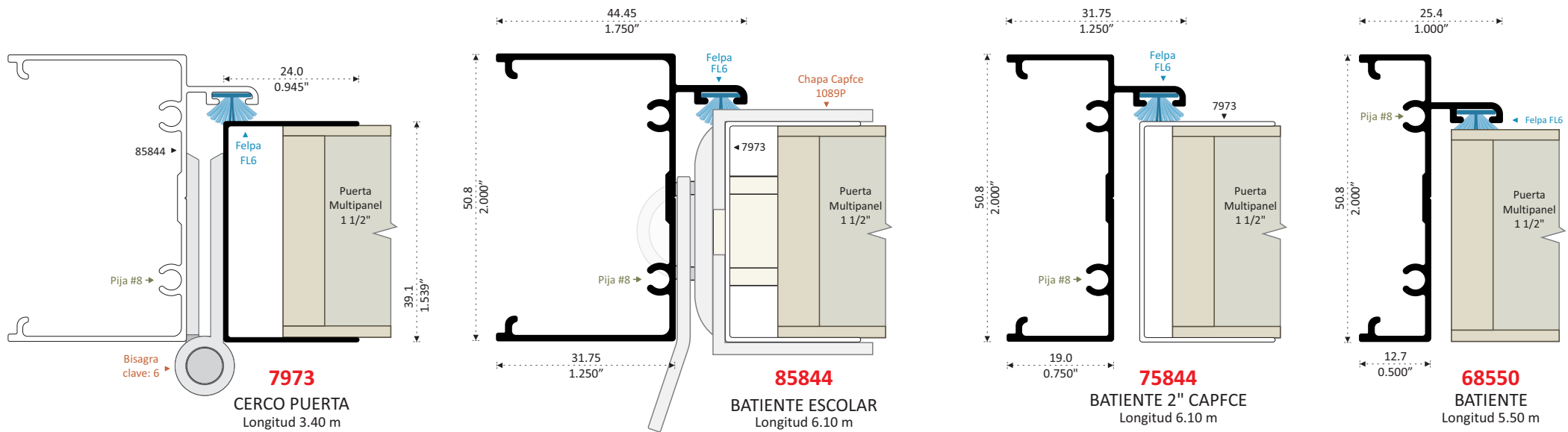

CHAPAS ESCOLARES

PERFILETTO
1,000,000 CICLOS



Llave- Llave
1089P

Natural Mate

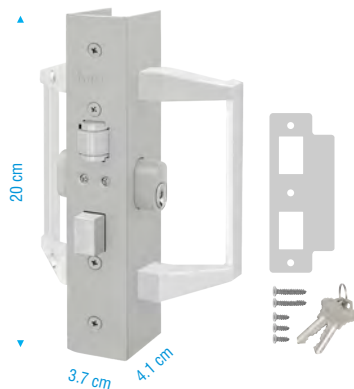

Resbalón y Contra **Resistentes a la Corrosión**

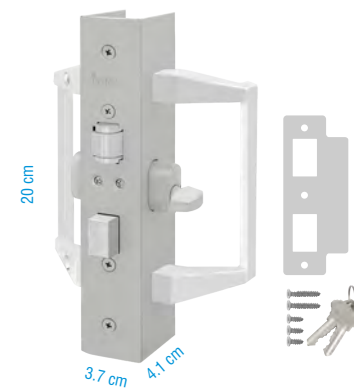

Llave- Mariposa
472P

Natural Mate

Línea 2" Ventana de Guillotina

Convierte un Producto Perfiletto En Algo Extraordinario

Felpas en Traslapes
Aumenta Hermeticidad a:
Polvo, Ruido y Viento

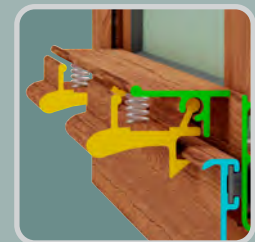
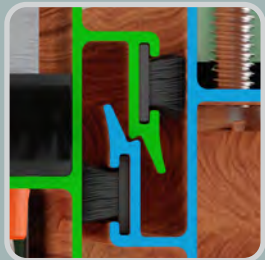

2 Broches Jaladeras
al Cierre

Salida de Agua Eficiente
Por su Inclínación

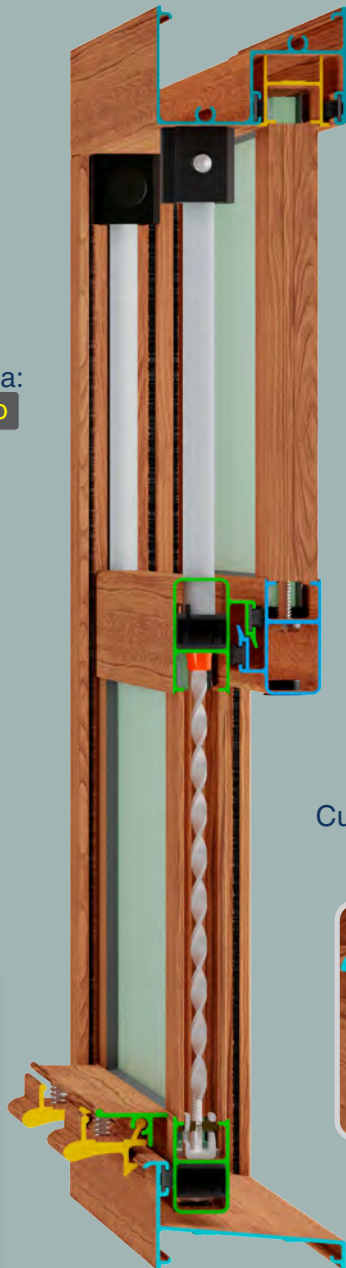
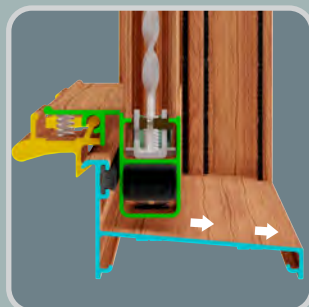

Desplazamiento Suave
Que Permite Detener en
Cualquier Parte del Recorrido



Cierre Suave
por Esquina
Redondeada

Juego de Herraje Incluye:

Piezas Superior con Tapón



- Mantiene el Balancin en Vertical
- Oculta la Pija por su Tapón
- Tope en Apertura Máxima



Guias Centrales con Felpa



- En Apertura y Cierre:
- Sin Juego de Hoja Móvil
 - Fijación Directa Sin Ajuste
 - Suave Desplazamiento por sus Felpas Laterales



Guias Inferiores con Felpa

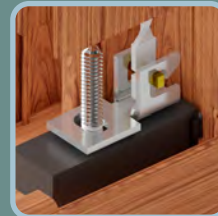

- En Apertura y Cierre:
- Sin Juego de Hoja Móvil
 - Fijación Directa Sin Ajuste
 - Suave Desplazamiento por sus Felpas Laterales
 - Refuerza el Atornillado del Bracket

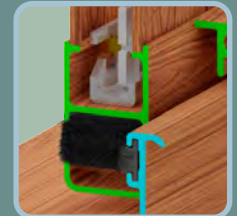

Descubre otras Opciones para tu Cancelería

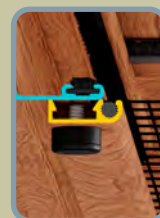

Mosquitero
Fijo

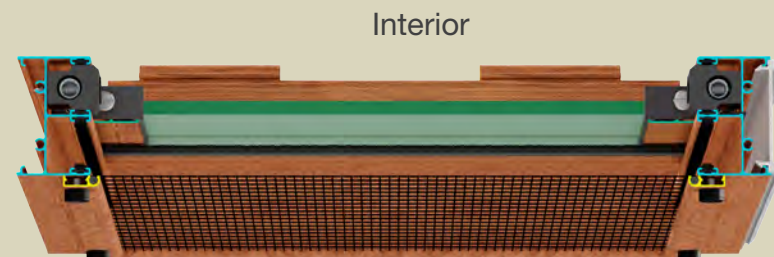

Interior

Exterior

Ensamble
de la Línea
con
Moldura Unión

■ Aislamiento Acústico Con 79954 37.0 Decibles
Con 79955 38.1 Decibles

■ Permeabilidad a Viento y Polvo Aire que Detiene 87 %

■ Resistencia A Vientos Sin Deformar el Perfil 120 Km/h

PRUEBAS EN NUESTRO CENTRO DE INVESTIGACIÓN Y DESARROLLO
Armadas con Perfiles y Complementos Esenciales 100% Perfiletto

AISLAMIENTO ACÚSTICO
REALIZADO CON 120 DECIBELES AL EXTERIOR
MEDIDA 1.00 x 1.00 m

AISLAMIENTO
37.0
Decibeles
CRISTAL DE 6 mm

LÍNEA EXCLUSIVA PERFILETTO

AISLAMIENTO
38.1
Decibeles
CRISTAL DE 6 mm

PERMEABILIDAD AL AGUA DURANTE 20 MINUTOS
VENTANA 1.00 x 1.00 m

VELOCIDAD KM/H	Agua	Aire
20	50%	50%
40	50%	50%
60	50%	50%
80	50%	50%
100	50%	50%
120	60%	40%

SIN MOSQUITERO
Sin Filtraciones

MOSQUITERO FIJO 67333
Sin Filtraciones

PERMEABILIDAD AL VIENTO Medida 1.00 x 1.00 m

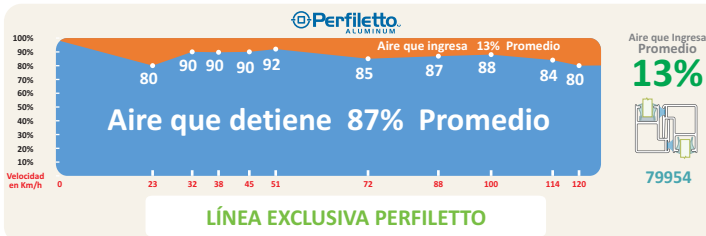

RESISTENCIAS A VIENTOS

VENTANA
Prueba Realizada
30 Repeticiones de 1 Minuto c/u
A 120 Km/h
Medida 1.00 x 1.00 m
Cristal 6 mm
LOS PERFILES SIN DEFORMACIÓN CONSERVAN SU FUNCIONAMIENTO

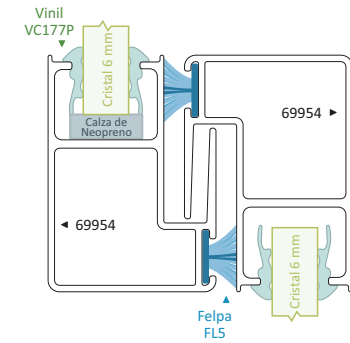
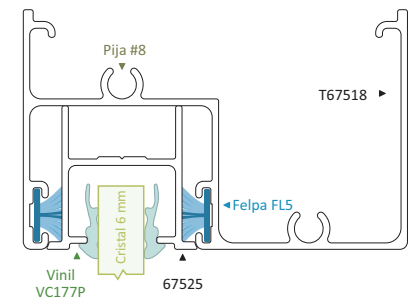

11763
MOSQUITERO FIJO
Longitud 6.10 m

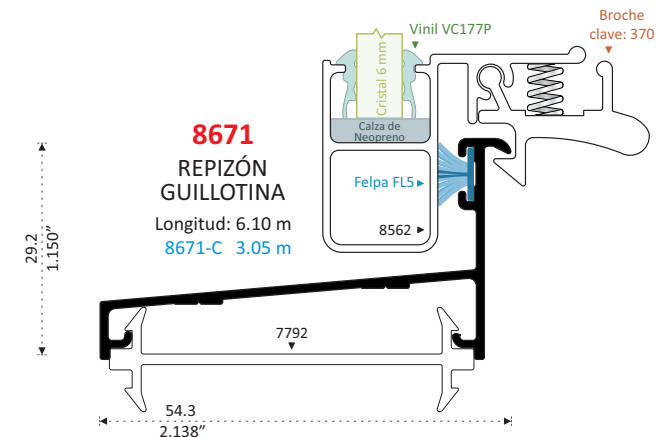
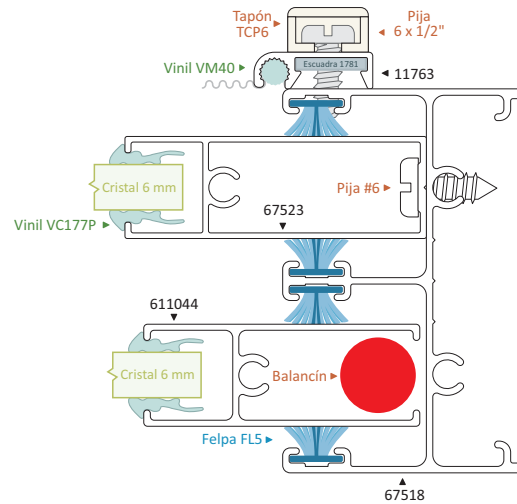
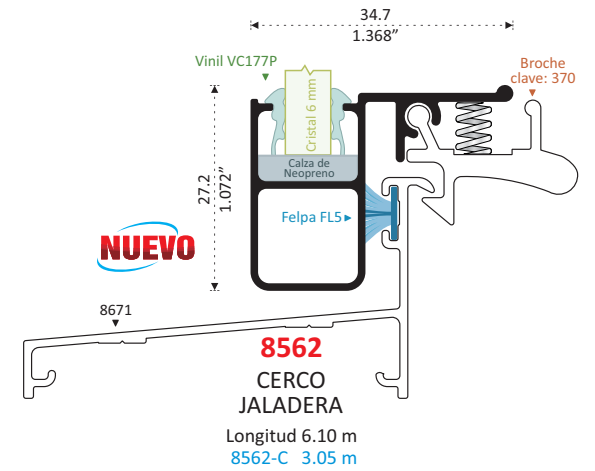
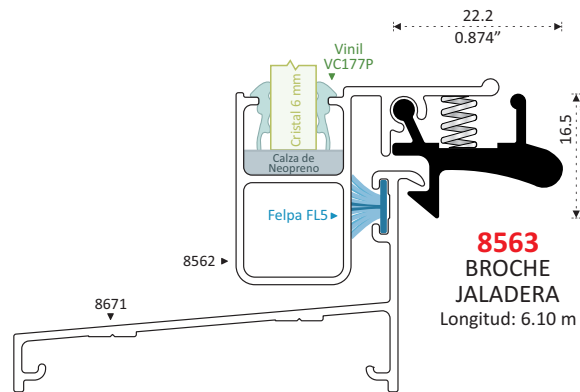
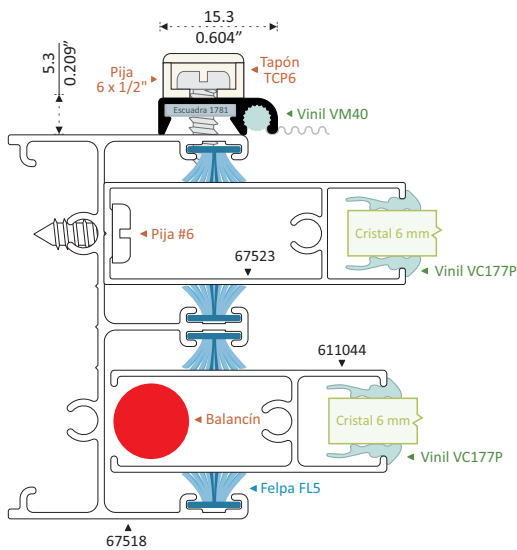

Línea 2" Sifón

Convierte un Producto Perfiletto En Algo Extraordinario

Línea que Permite Mayor Vista y Ventilación

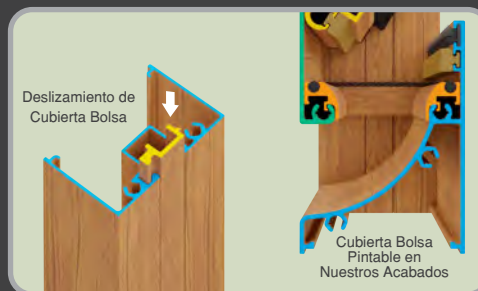
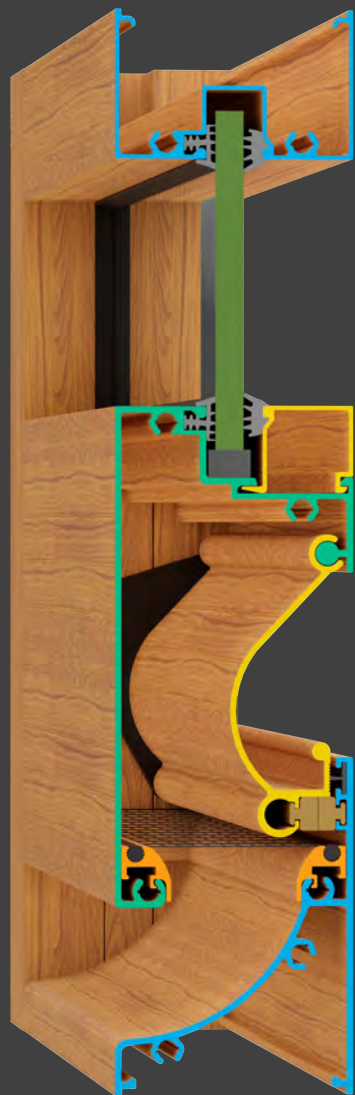

Cubierta Bolsa

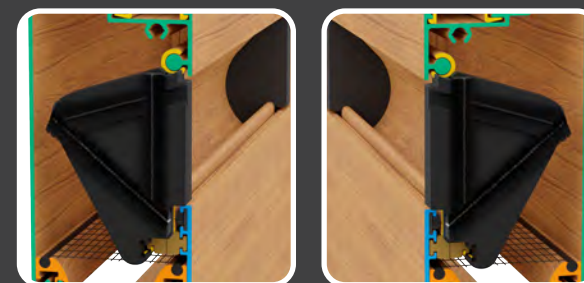

Sello Hermético por sus 2 Tapas Laterales de 3 Felpas con Aletas



Vista de Bolsa con Cubierta Bolsa

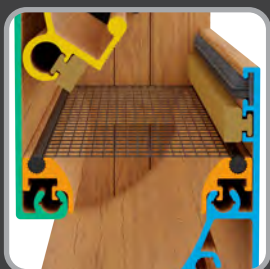

Mosquitero Horizontal Oculto

Colocación por el Exterior

Cierre con Imanes

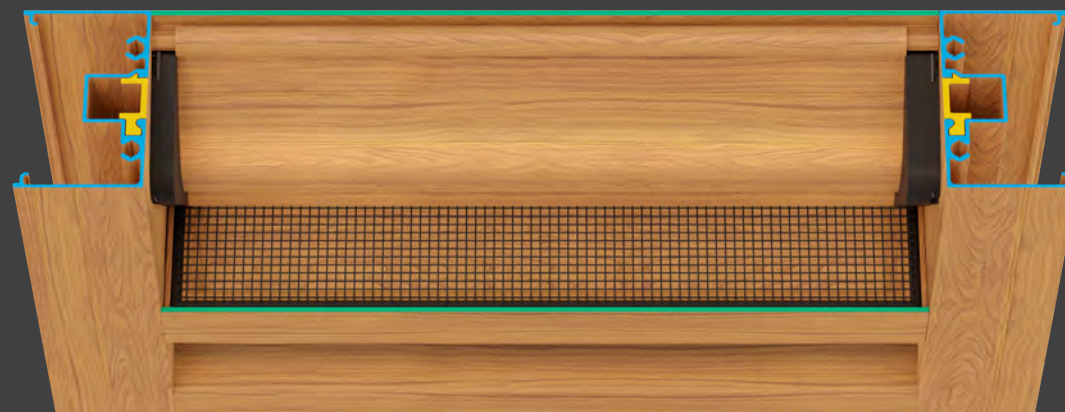

Descubre otras Opciones para tu Cancelería

Poste Intermedio Listo para Ensamblar



Colocación como Máximo cada 1.50 m de Ancho

Colocar en el Mismo Acabado

Cristal Doble

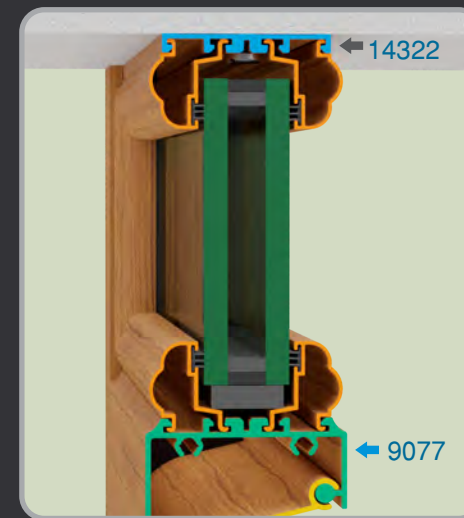

Sello Hermético y Cierre Suave por sus 2 Tapas Laterales de 3 Felpas con Aletas

CERRADO

Mayor Entrada de Aire Por su Diseño Aerodinámico

ABIERTO

■ Aislamiento Acústico
Cristal Sencillo 38.4 Decibles
Cristal Doble 42.8 Decibles

■ Permeabilidad a Viento y Polvo
Aire que Detiene 99 %

■ Resistencia A Vientos Sin Deformar el Perfil 120 Km/h

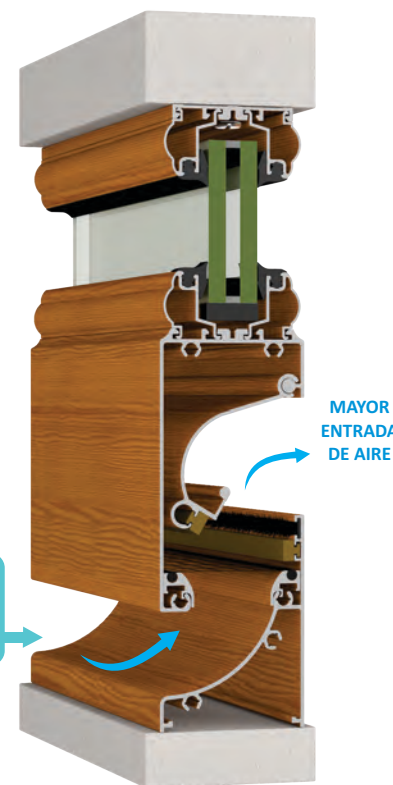
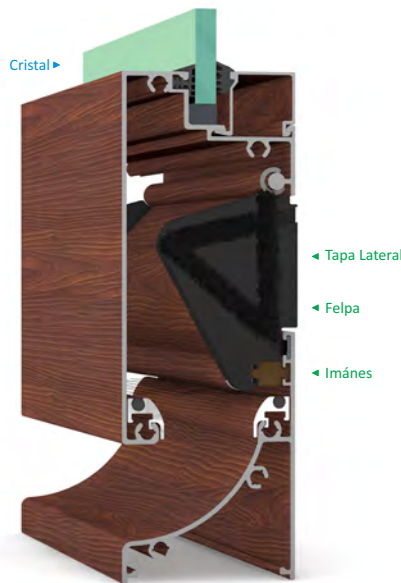

9080 PATENTE
ESCALONADO SIFÓN
Longitud 6.10 m
9080-C 3.05 m

9088 PATENTE
JUNQUILLO
Longitud 6.10 m

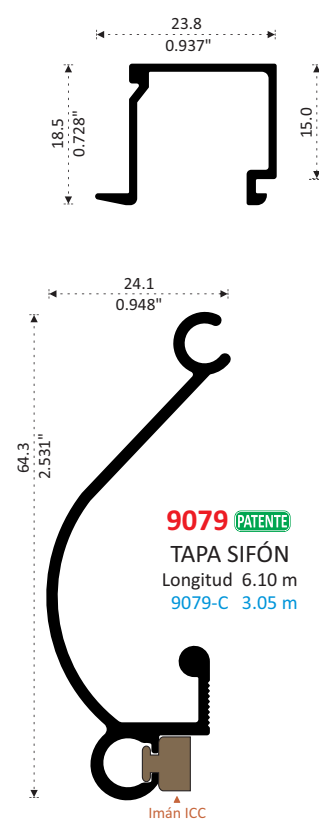
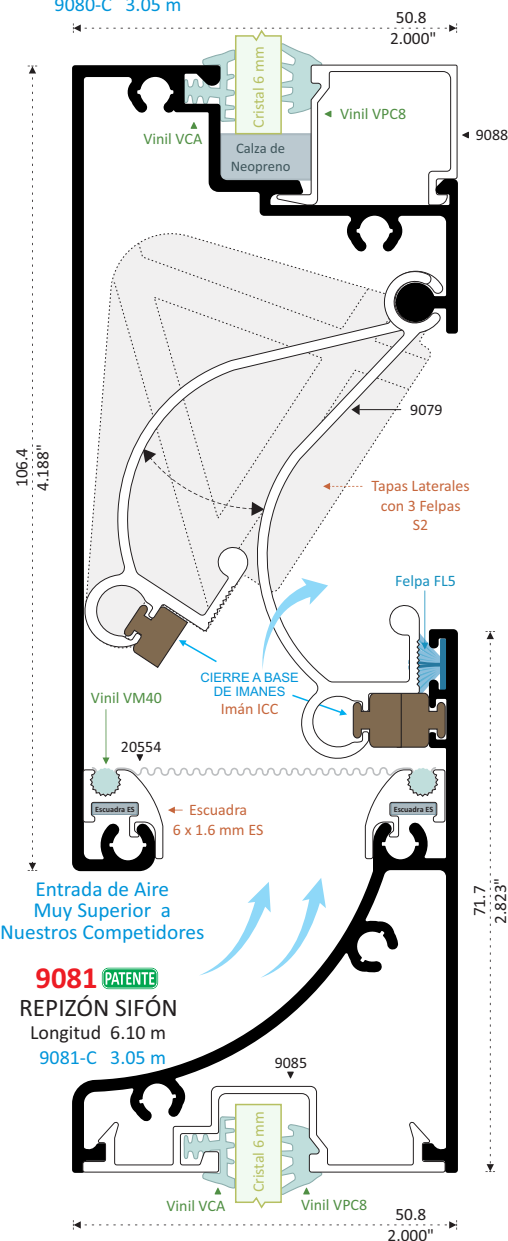

9079 PATENTE
TAPA SIFÓN
Longitud 6.10 m
9079-C 3.05 m

**MOSQUITERO SIFÓN
CON MAYOR VENTILACIÓN**

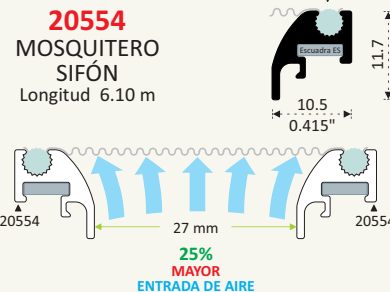

20554
MOSQUITERO
SIFÓN
Longitud 6.10 m

Probada en Nuestros Laboratorios a 200 Km/h
Logrando una Gran Hermeticidad



S2
Herrajes para Sifón de 2"

- Incluye:
- * Tapas Laterales, Izquierda y Derecha
 - * Cubiertas Bolsa Aluminio Anodizado
 - * Felpas con Labios de Plástico



ICC
Imán por Metro

Ancho Máximo Sugerido por Cajón : 1.50 m.
Listo para Ensamblar

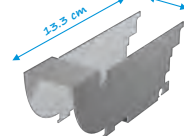

PS2
Intermedio 2"

- Blanco
- NM
- Champagne
- Electro
- Negro

Elija el Mismo Acabado, ya que queda expuesto

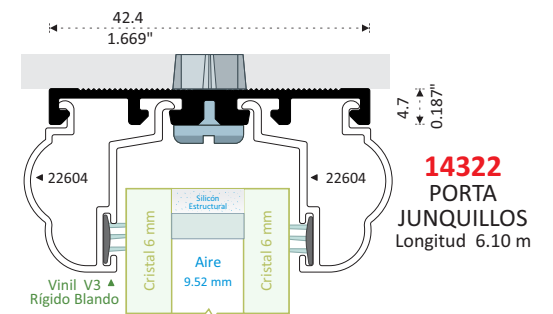

14322
PORTA
JUNQUILLOS
Longitud 6.10 m

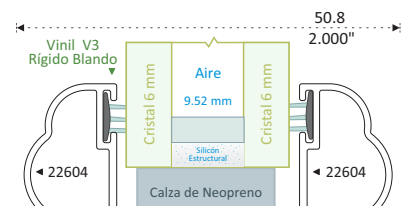

9077
PORTA
JUNQUILLOS
SIFÓN
Longitud 6.10 m

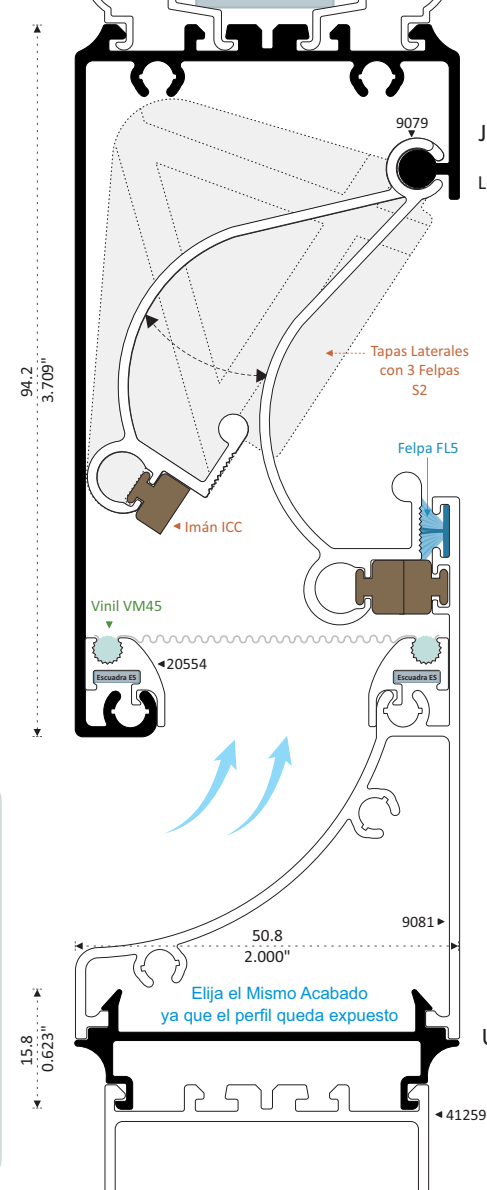

4050
MOLDURA
UNIÓN CURVA
Longitud 6.10 m

LÍNEA 2" BATIENTE O PROYECCIÓN

Proyección



Manija Batiente - Proyección

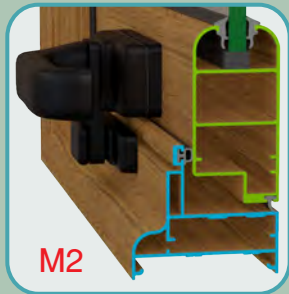

Guías Para Instalación de:



Brazos de Proyección



- Brazos Fricción



- Bisagras

Abatible



Armado Rápido de Marco con Escuadra de Botón EM35



Armado Rápido de Contramarco con Escuadra de Botón EC35



Ventajas Vinilos Base Rigida

- Colocación Rápida
- No se Contrae después de su Colocación
- Alta Resistencia a la Intemperie

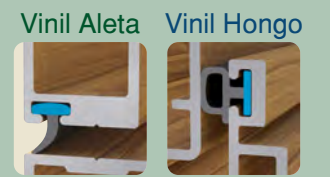

Aumentan la Hermeticidad:

- Acústica
- Viento
- Polvo
- Agua

Vista Frontal Sencilla y Elegante sin Vinil en el Marco



DESCUBRE OTRAS OPCIONES PARA TU CANCELERÍA

ELIGE EL ESTILO DE MOSQUITERO

Batiente Multi-Líneas



Cierre con Imanes

Fijo



Apertura y Cierre Con Operador de Brazo

■ Aislamiento Acústico Con 52274 44.3 Decibles

■ Permeabilidad a Viento y Polvo Con 52274 Aire que Detiene 96 %

■ Resistencia A Vientos Sin Deformar el Perfil 120 Km/h

PRUEBAS EN NUESTRO CENTRO DE INVESTIGACIÓN Y DESARROLLO

Armadas con Perfiles y Complementos Esenciales 100% Perfiletto

🔊 AISLAMIENTO ACÚSTICO

REALIZADO CON 120 DECIBELES AL EXTERIOR

MEDIDA 1.00 x 1.00 m



LÍNEA EXCLUSIVA PERFILETTO

PERMEABILIDAD AL AGUA DURANTE 20 MINUTOS

VENTANA MEDIDA 1.00 x 1.00 m

VELOCIDAD KM/H	Agua	Aire
20	50%	50%
40	50%	50%
60	50%	50%
80	50%	50%
100	50%	50%
120	60%	40%

SIN MOSQUITERO

Sin
Filtraciones

MOSQUITERO FIJO
15173

Sin
Filtraciones

PERMEABILIDAD AL VIENTO Medida 1.00 x 1.00 m

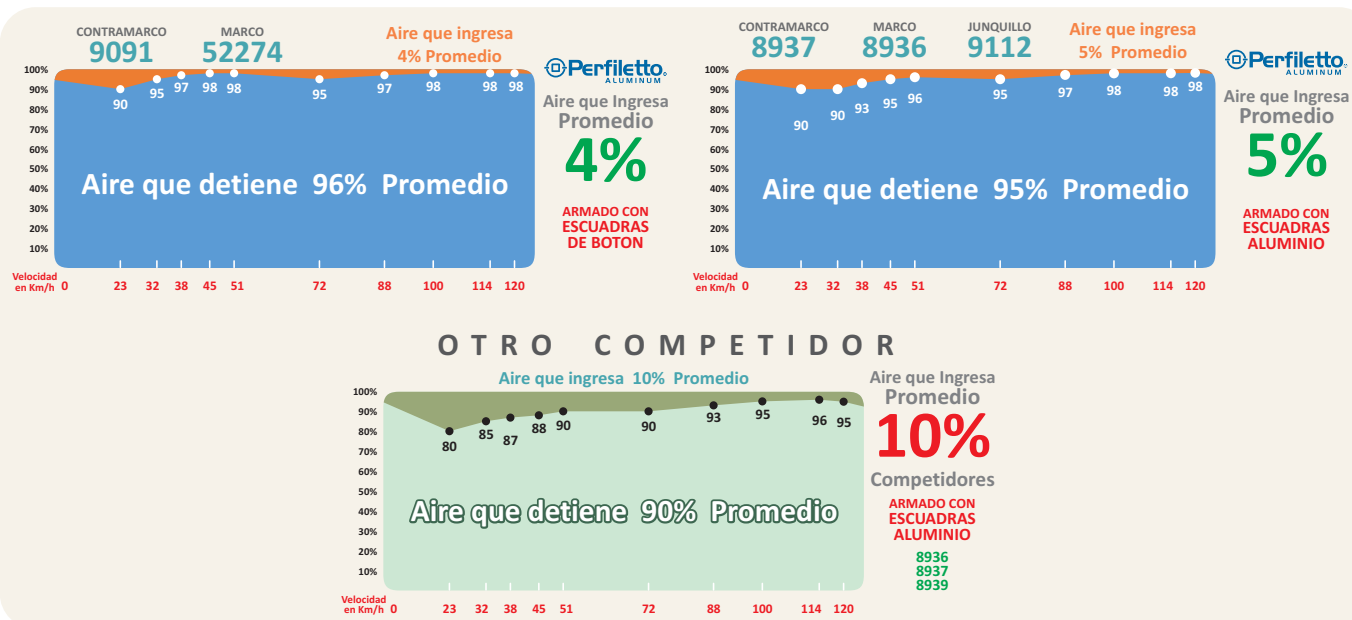

RESISTENCIAS A VIENTOS

VENTANA

Prueba Realizada
30 Repeticiones de 1 Minuto c/u
A 120 Km/h

Medida 1.00 x 1.00 m
Cristal 6 mm

**LOS PERFILES SIN DEFORMACIÓN
CONSERVAN SU
FUNCIONAMIENTO**

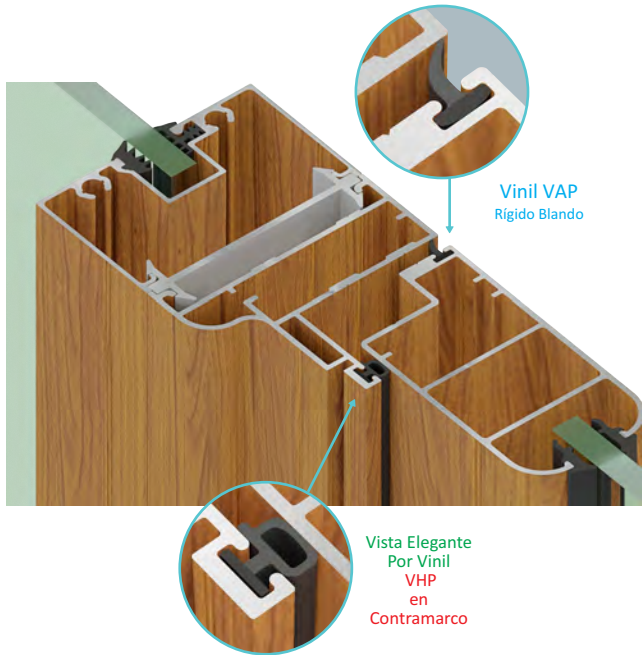

32274 PATENTE
MARCO COLONIAL
Longitud 6.10 m

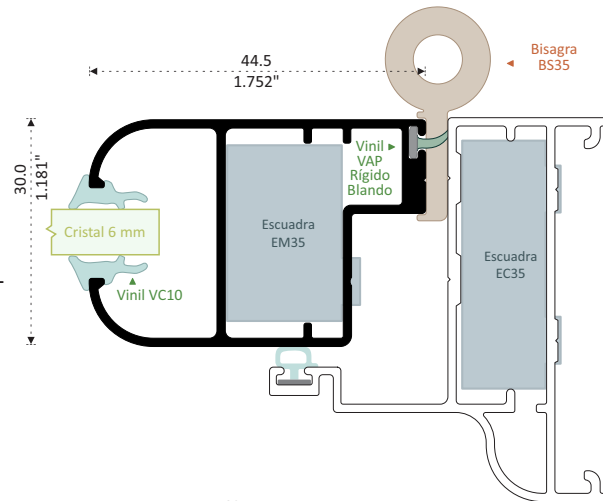

VENTANA BATIENTE

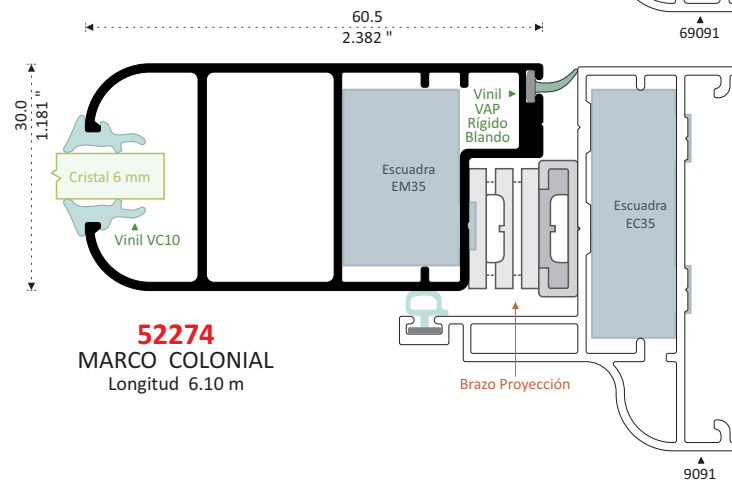

VENTANA PROYECCIÓN



52274
MARCO COLONIAL
Longitud 6.10 m

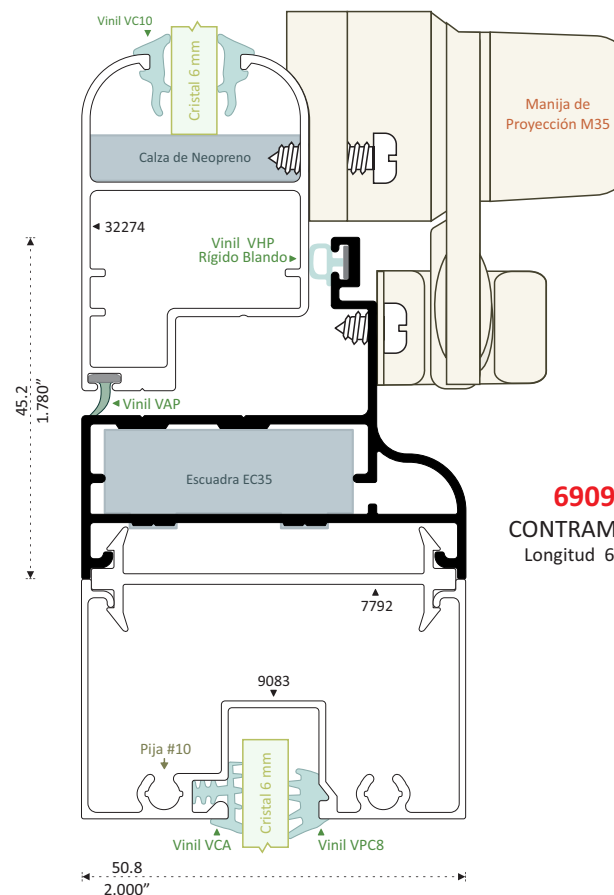
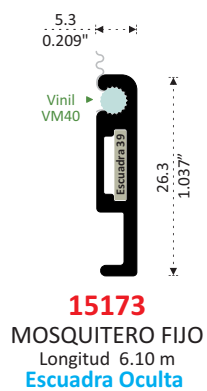
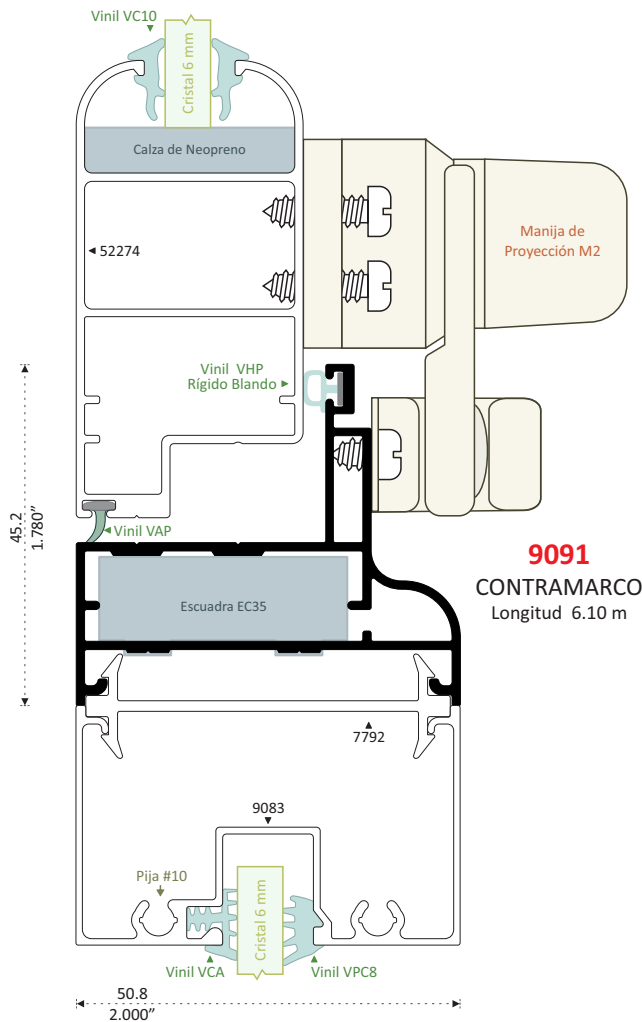

Armado de Marco con Escuadra EM35

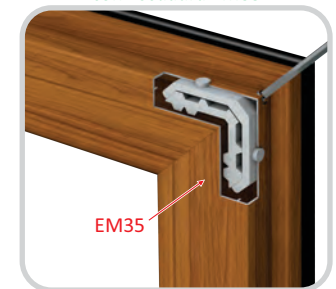

AJUSTA Y CIERRA EL CORTE

Armado de Contramarco con Escuadra EC35



AJUSTA Y CIERRA EL CORTE

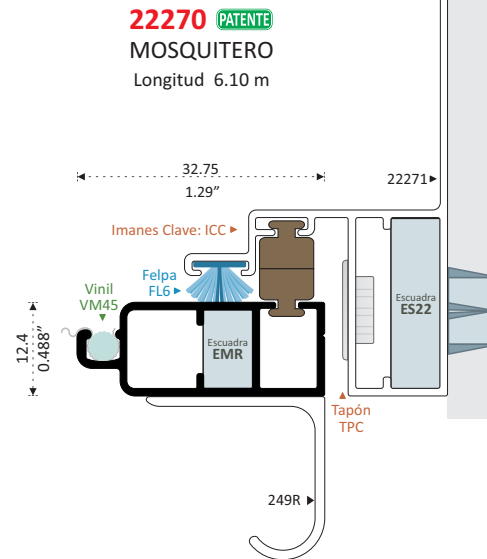
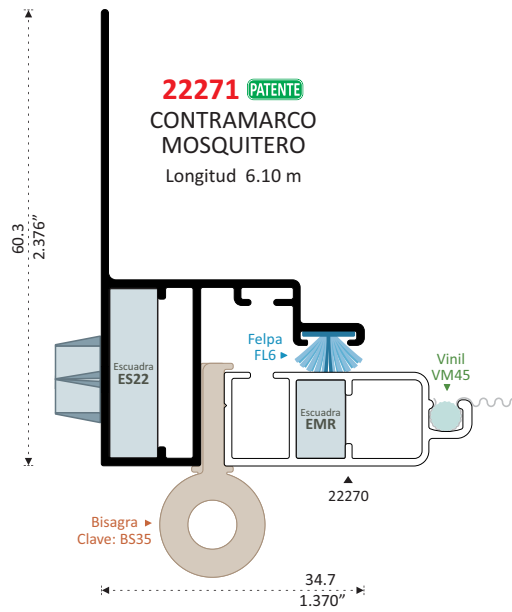

Mosquitero
Batiente
Multilíneas

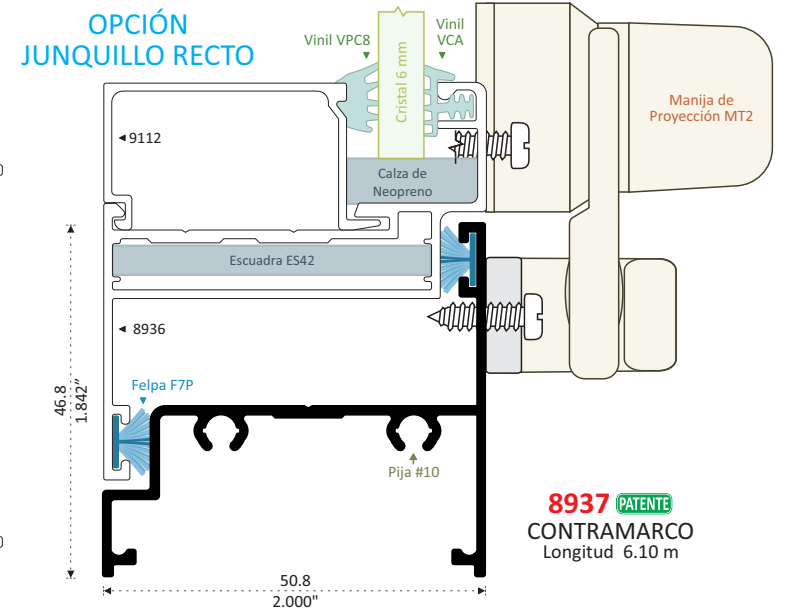
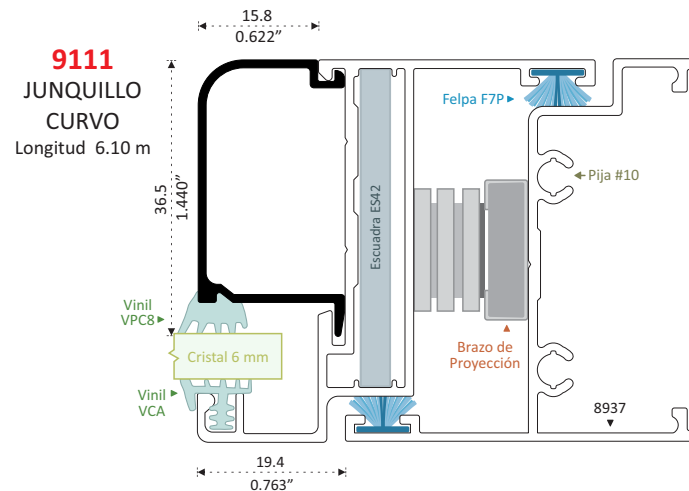
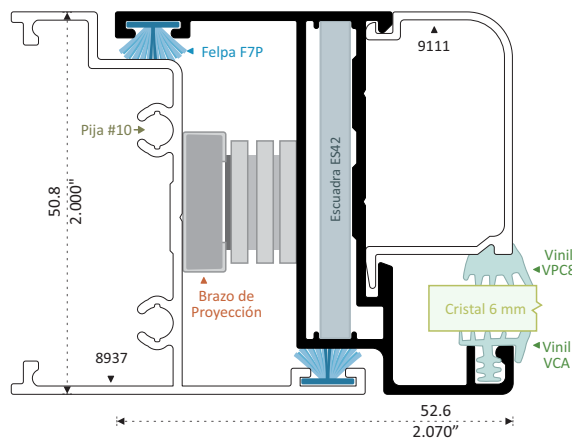

BATIENTES PUERTA

MADERA "o" MULTIPANEL

PUERTA 1 3/8"

PUERTA 1 1/2"

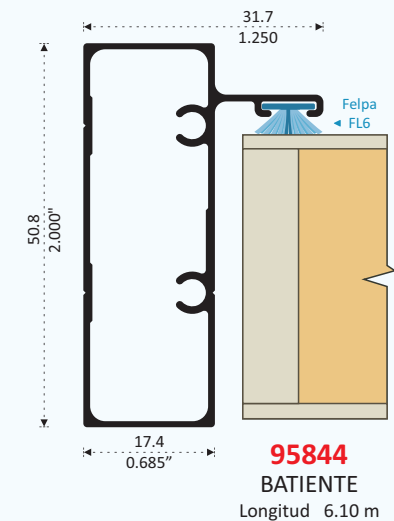
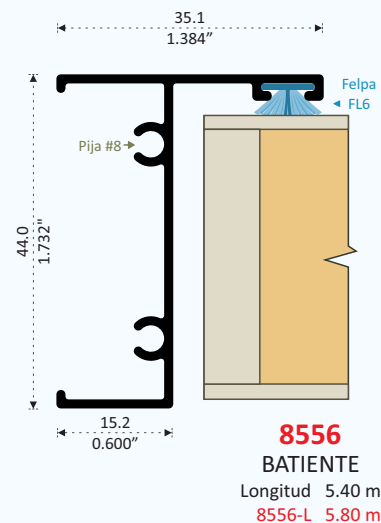
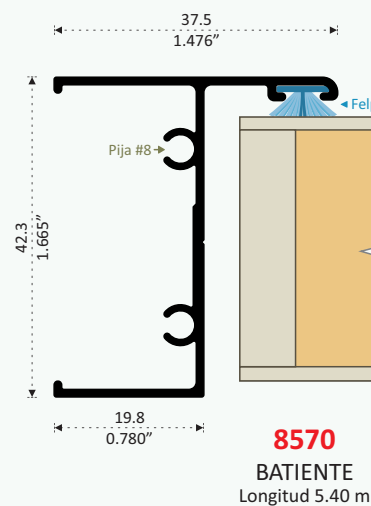
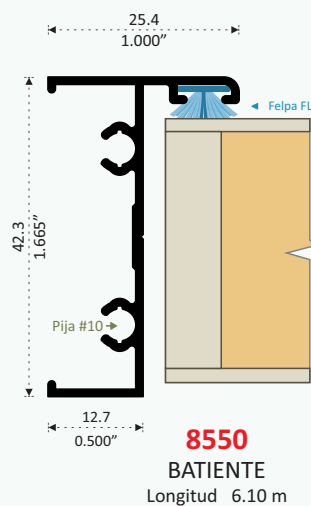

NUEVO

LÍNEA 2" PUERTA BATIENTE COMERCIAL

PRUEBAS EN NUESTRO CENTRO DE INVESTIGACIÓN Y DESARROLLO
Armadas con Perfiles y Complementos Esenciales 100% Perfiletto



FELPA F11P



VC12 Ambos lados



FELPA FL6



BISAGRA 1524L



AISLAMIENTO ACÚSTICO

REALIZADO CON 120 DECIBELES AL EXTERIOR
MEDIDA 0.95 X 2.20 m



COMPETIDORES

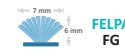

FELPA FG



BISAGRA LIBRO



PERMEABILIDAD AL AGUA

DURANTE 20 MINUTOS

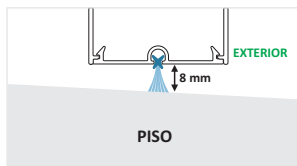

Desnivel de Piso
3° Grados

Sin
Filtraciones

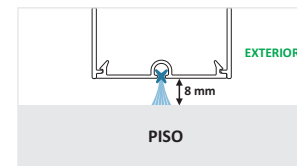

Desnivel de Piso
0° Grados

Con
Filtraciones

PERMEABILIDAD AL VIENTO

Medida 1.00 x 1.00 m



BATIENTE 35844



CERCO CHAPA 69204



SELO HERMETICIDAD 19188



FELPA FL6



FELPA F11P



FELPA F12P



Aire que Ingresa Promedio
19%

RESISTENCIAS A VIENTOS

PUERTA

Prueba Realizada
 30 Repeticiones de 1 Minuto c/u
 A 120 Km/h
 Medida 0.95 X 2.20 m
 Cristal 6 mm
 Duela 16617

LOS PERFILES SIN DEFORMACIÓN
 CONSERVAN SU
 FUNCIONAMIENTO

COMPETIDORES

CERRADA INGRESA ALTAS CANTIDADES DE AIRE Y POLVO

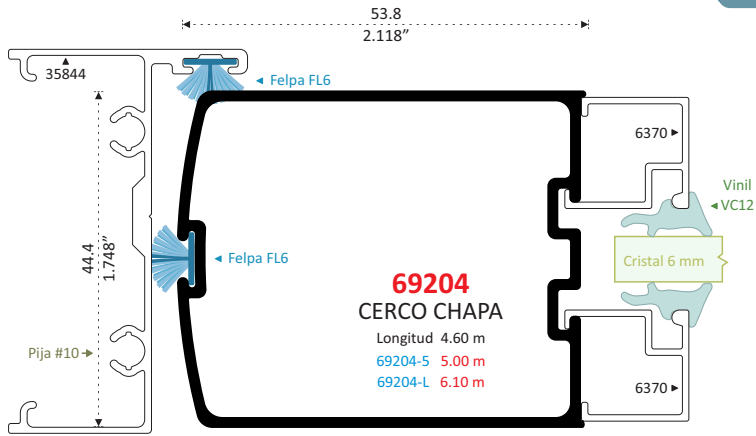

1524L EXCLUSIVA 69204
NO COMPATIBLES CON
OTRAS MARCAS DE PERFILES

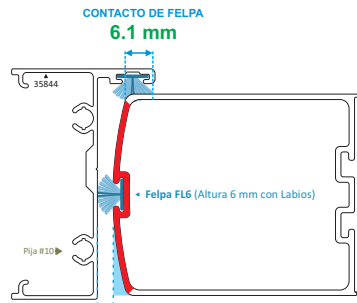

**CURVATURA
PERFILETTO**

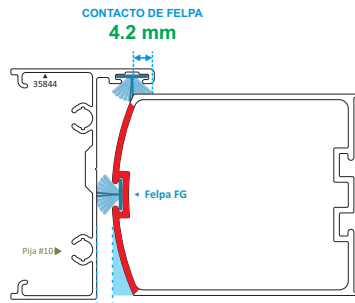

**CURVATURA
COMPETIDORES**

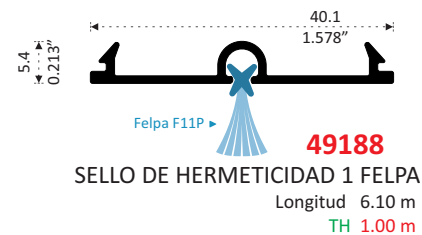
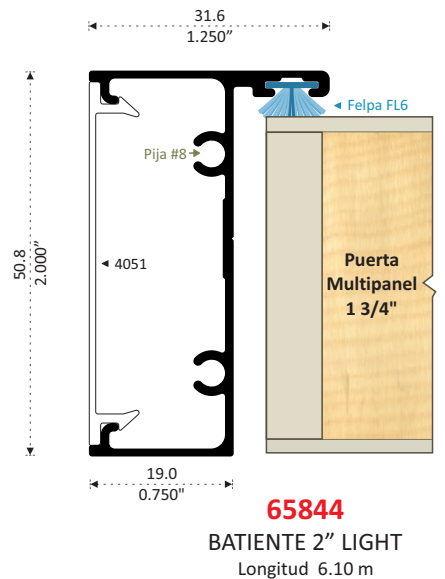
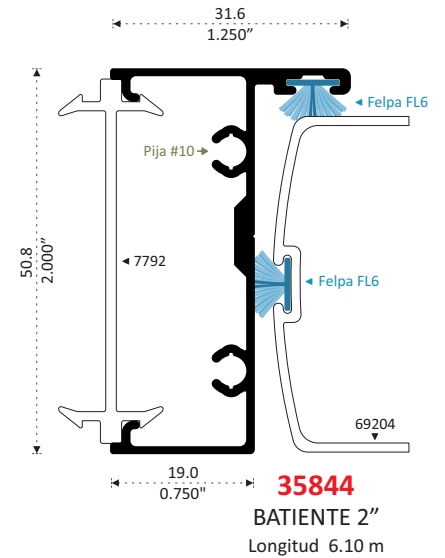
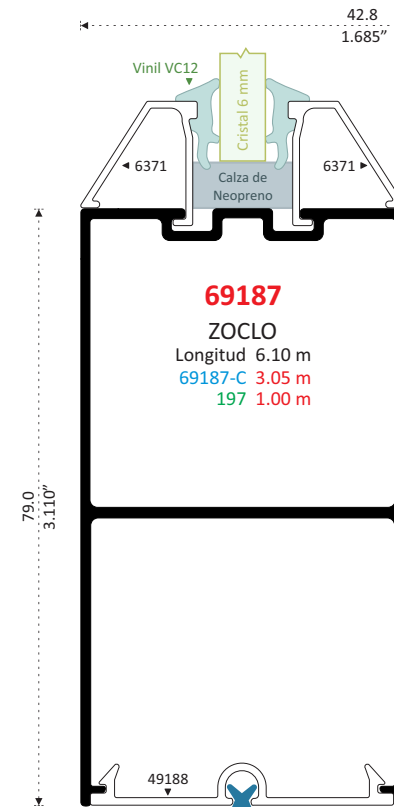
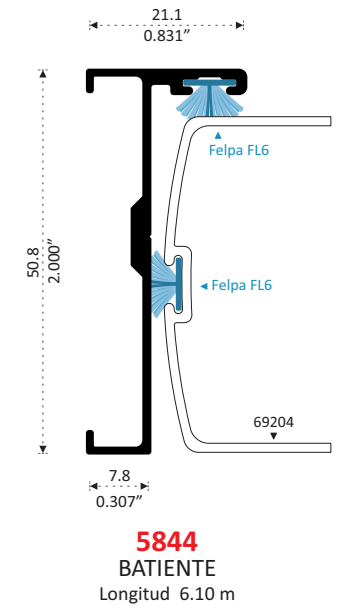
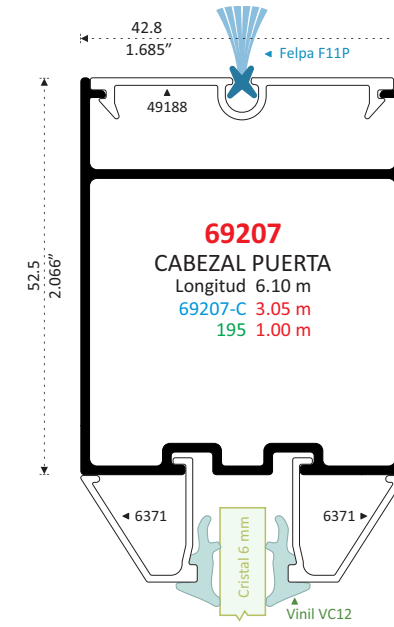
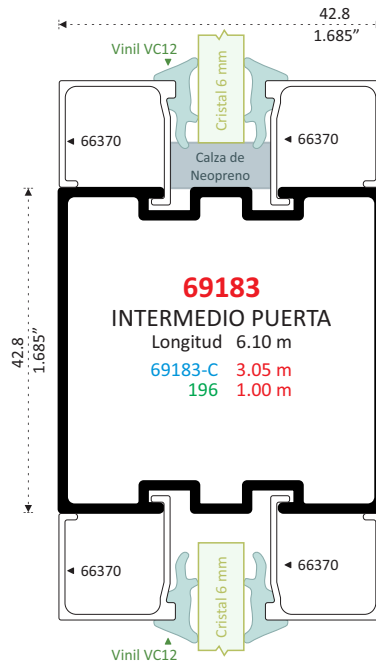
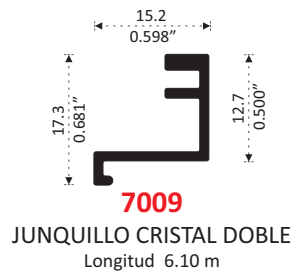
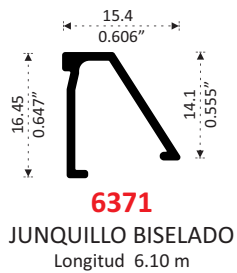
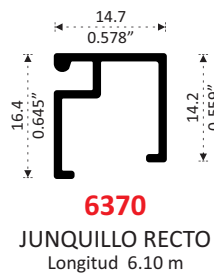
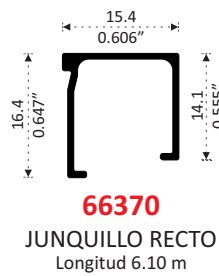

LÍNEA 3" ECONÓMICA HERMÉTICA

Convierte un Producto Perfiletto En Extraordinario

MAYORES GANANCIAS
Elige contramarco Horizontal sin venas



Armado Horizontal Superior

Armado Hoja Fija

MÁS RÁPIDO

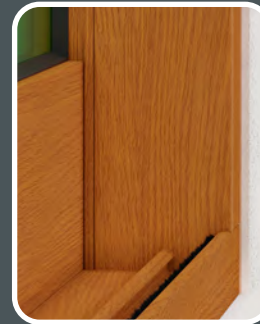
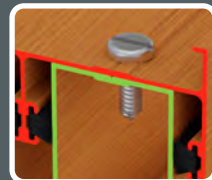

Vista Distinguida y Más Económica

Cerco Fijo da Apariencia de un Perfil Integrado al Contramarco

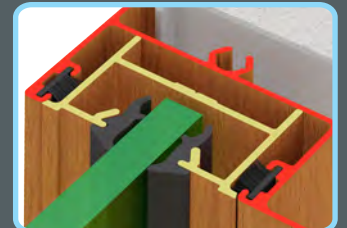

Más Acercamiento de Felpas logrando Mayor Hermeticidad

Atornille una sola vez los Traslapes, Acristale en Mesa Hojas Fija y Corrediza



Colocación Rápida de Hoja Corrediza y Hoja Fija Con Atornillado por el Exterior, en Zoclo y Cabezal

Pijas sin Contacto con el Cristal

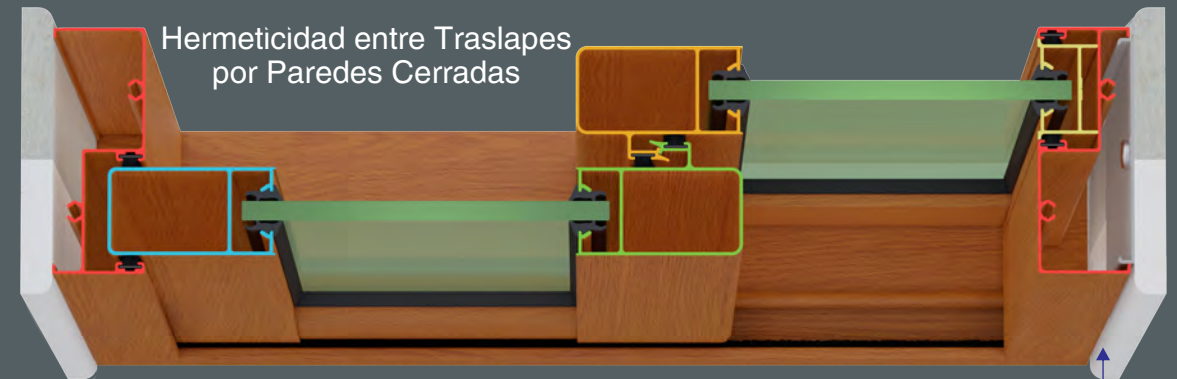

Hermeticidad entre Traslapes por Paredes Cerradas

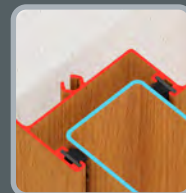

Ofrece la Experiencia de un Cierre Suave y Silencioso

Por Cerco con Esquinas Curvas y Contacto de Felpas al 100%

Fijación Invisible con Moldura de Fijación a Muro

CTA3



Ventana

Puerta

Cubiertas Traslapes

Maximiza la Hermeticidad a Viento y Polvo, entre Traslapes, Contramarco y Riel hasta un

85%



MAYOR ACERCAMIENTO de Felpa con Zoclo

Zoclo de Hoja Fija con Mayor Resistencia ante Ráfagas de Viento



Atornilla por Fuera

Descubre otras Opciones para tu Cancelería

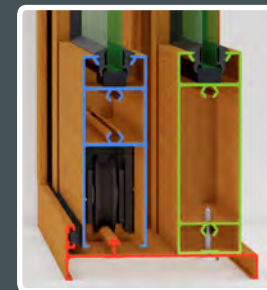

Zoclo Puerta



Mosquitero Horizontal Doble Vena R6533

■ Aislamiento Acústico 77848 36.2 Decibles

■ Permeabilidad a Viento y Polvo 77848 Aire que Detiene 92 %

■ Resistencia A Vientos Sin Deformar el Perfil Ventana 120 Km/h Puerta 110 Km/h

AISLAMIENTO ACÚSTICO
REALIZADO CON 120 DECIBELES AL EXTERIOR
MEDIDA 1.00 x 1.00 m



LÍNEA EXCLUSIVA PERFILETTO

PERMEABILIDAD AL AGUA DURANTE 20 MINUTOS

VELOCIDAD KM/H			VENTANA MEDIDA 1.00 x 1.00 m			MOSQUITERO CORREDIZO EXTERIOR 66533 y 66534			
Agua	Aire		SIN MOSQUITERO	MOSQUITERO FIJO 7336	MOSQUITERO CORREDIZO INTERIOR 6533 y 6534	Agua	Aire	Litros Filtrados	
20	50%	50%	Sin Filtraciones	Sin Filtraciones	Sin Filtraciones	20	50%	50%	1.21
40	50%	50%				40	50%	50%	1.49
60	50%	50%				60	50%	50%	1.62
80	50%	50%				80	50%	50%	1.65
100	50%	50%				100	50%	50%	1.70
120	60%	40%				120	60%	40%	1.78

Otros Mosquiteros Fijos Ocasionan Filtraciones Por su Altura Mayor Respecto al Riel

MOSQUITERO CORREDIZO EXTERIOR OCASIONA ALTA FILTRACIÓN DE AGUA

VELOCIDAD KM/H			PUERTA MEDIDA 1.00 x 1.00 m		MOSQUITERO CORREDIZO EXTERIOR 66533 y 66534			
Agua	Aire		SIN MOSQUITERO	MOSQUITERO CORREDIZO INTERIOR 6533 y 6534	Agua	Aire	Litros Filtrados	
20	50%	50%	Sin Filtraciones	Sin Filtraciones	20	50%	50%	1.23
40	50%	50%			40	50%	50%	1.53
60	50%	50%			60	50%	50%	1.65
80	50%	50%			80	50%	50%	1.69
100	50%	50%			100	50%	50%	1.73
120	60%	40%			120	60%	40%	1.80

MOSQUITERO CORREDIZO EXTERIOR OCASIONA ALTA FILTRACIÓN DE AGUA

PERMEABILIDAD AL VIENTO Medida 1.00 x 1.00 m

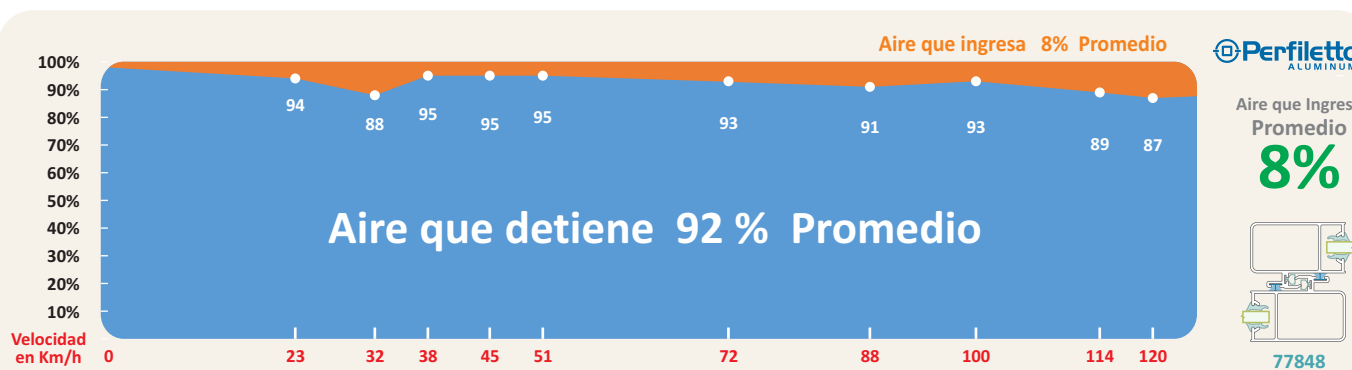

LÍNEA EXCLUSIVA PERFILETTO

RESISTENCIAS A VIENTOS

VENTANA
Prueba Realizada
30 Repeticiones de 1 Minuto c/u
A 120 Km/h
Medida 1.00 x 1.00 m
Cristal 6 mm
LOS PERFILES SIN DEFORMACIÓN
CONSERVAN SU FUNCIONAMIENTO

PUERTA
Prueba Realizada
30 Repeticiones de 1 Minuto c/u
A 110 Km/h
Medida 2.00 X 2.10 m
Cristal 6 mm
LOS PERFILES SIN DEFORMACIÓN
CONSERVAN SU FUNCIONAMIENTO

Ruptura de Cristal a 120 km/h

S77826

CONTRAMARCO SIN VENAS

Longitud 6.10 m

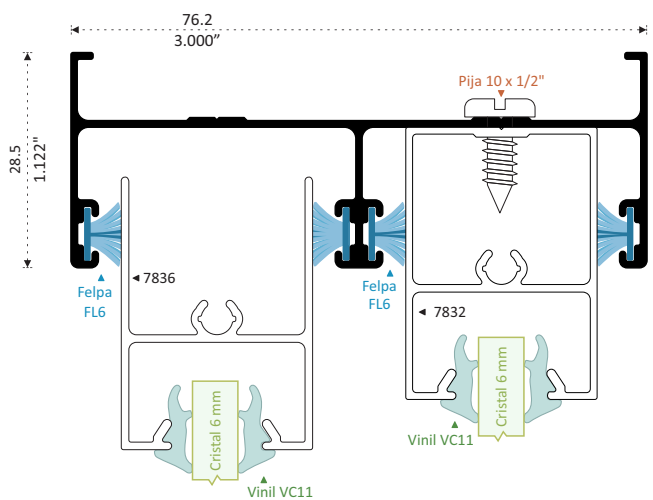

S77862 PATENTE

CONTRAMARCO MOSQUITERO CORREDIZO SIN VENAS

Longitud 6.10 m

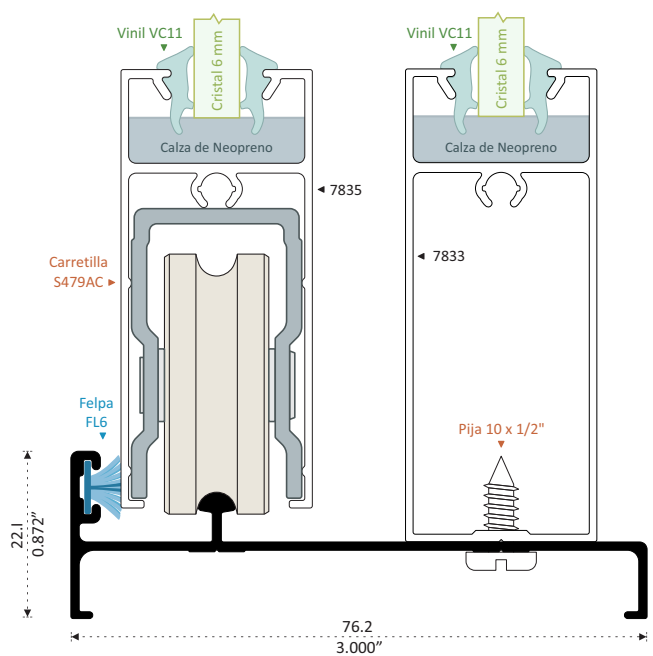
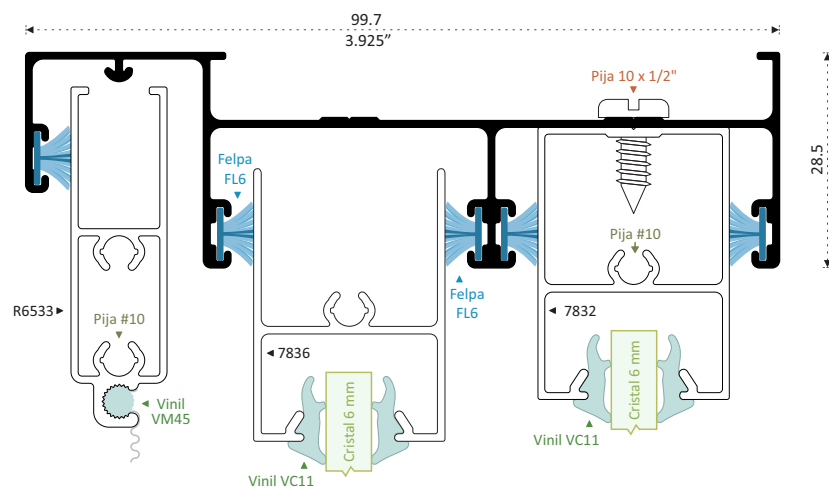

79957

RIEL

Longitud 6.10 m

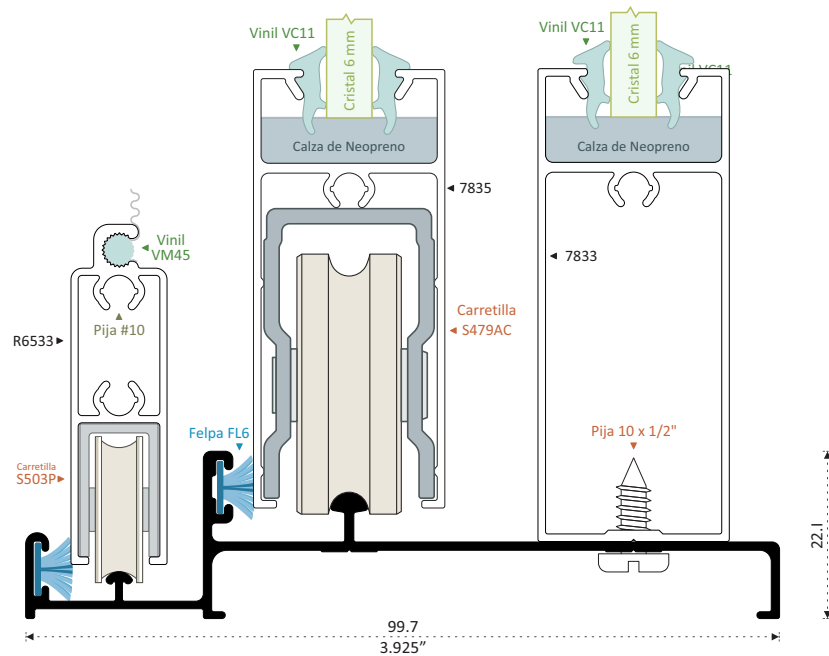

79274

RIEL CON MOSQUITERO INTERIOR

Longitud 6.10 m

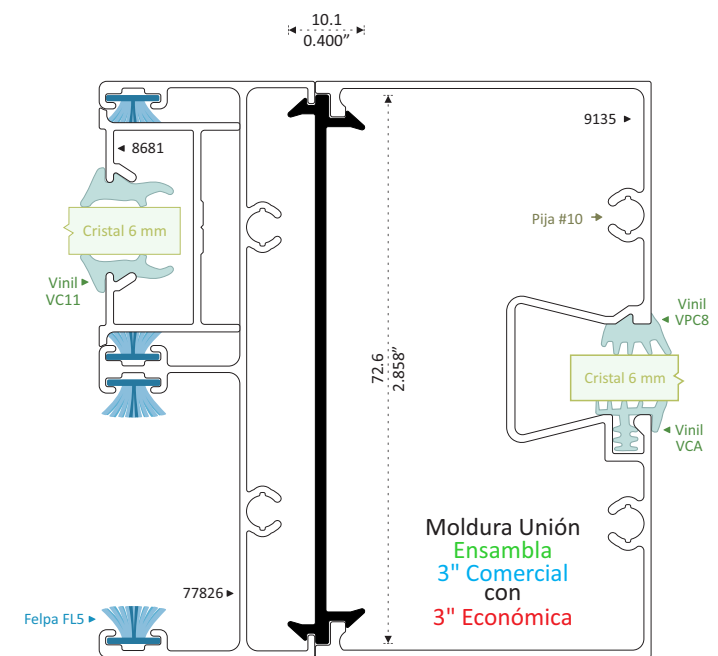
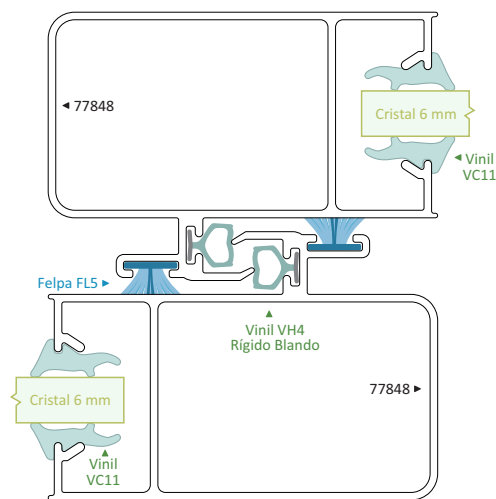
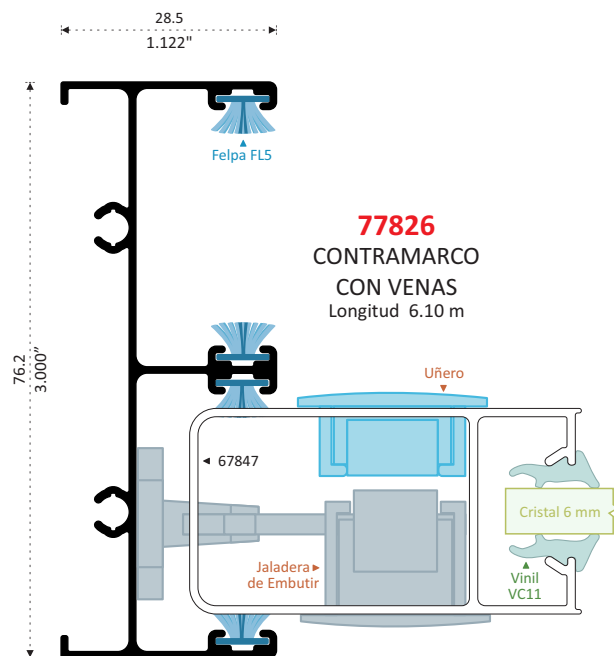
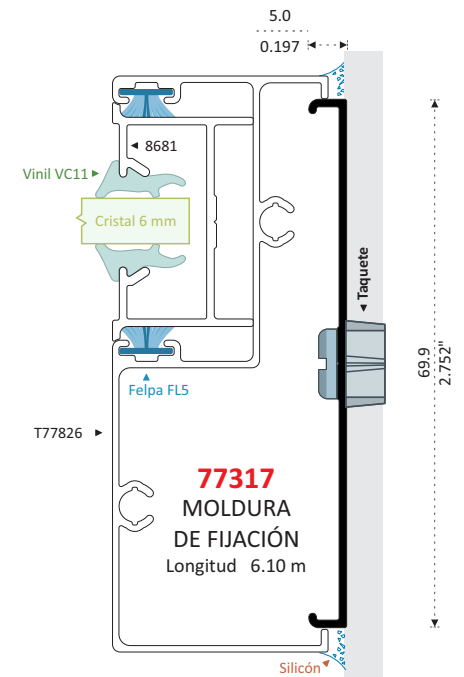
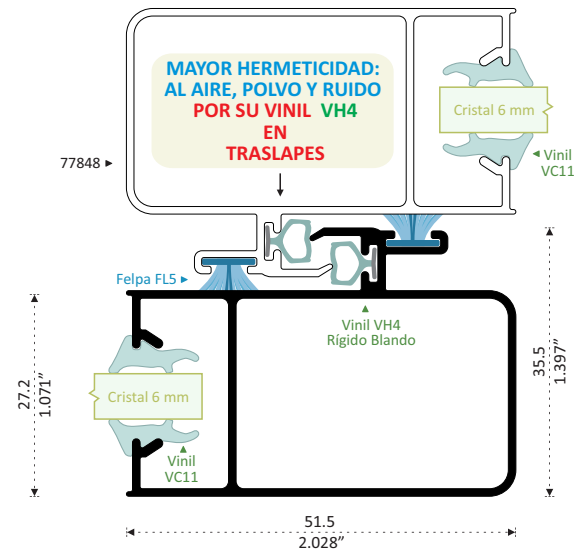
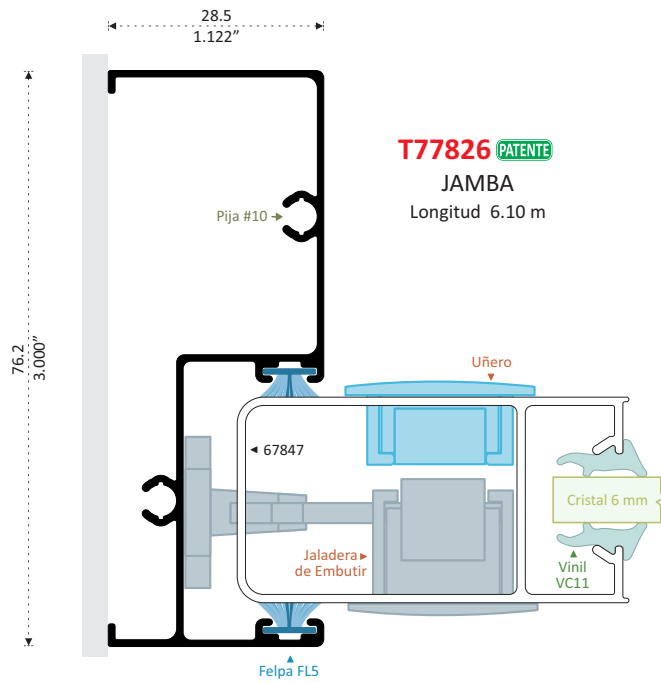

10265
**MOLDURA
UNIÓN**
Longitud 6.10 m

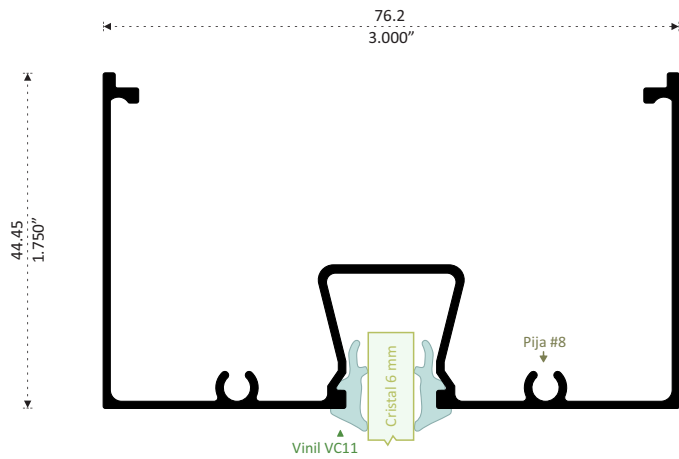

69135
BOLSA
Longitud 6.10 m

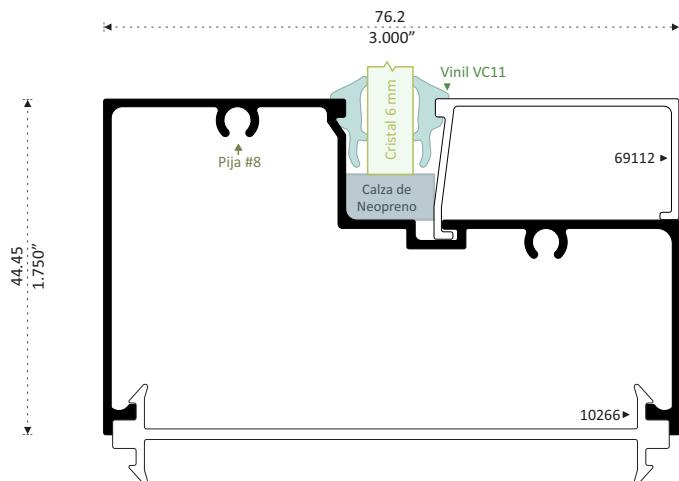
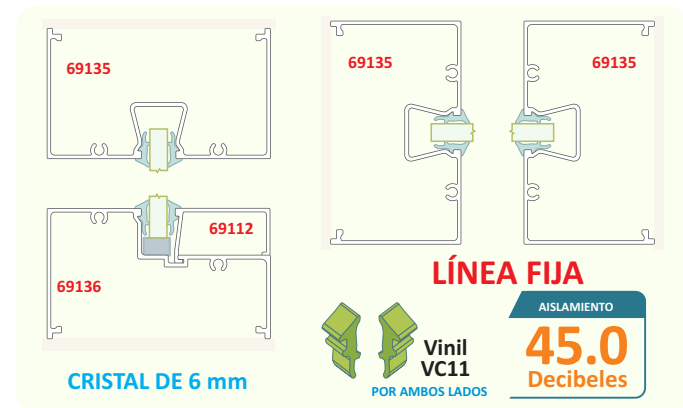

69136
ESCALONADO
Longitud 6.10 m

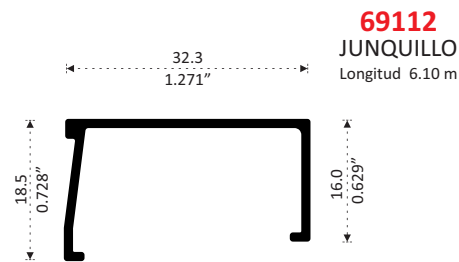

69112
JUNQUILLO
Longitud 6.10 m

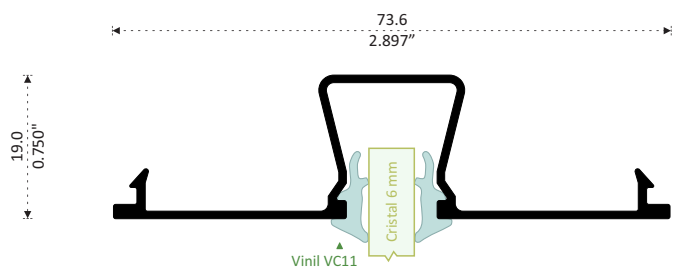

67315
TAPA BOLSA
Longitud 6.10 m

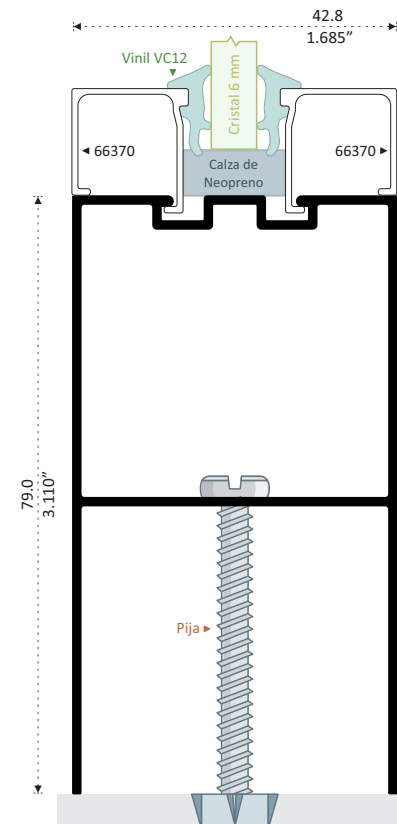

9131
ZOCLO FIJO LIGHT
Longitud 6.10 m



 **Perfiletto**[®]
ALUMINUM

LÍNEA 3" LIGHT HERMÉTICA

Convierte un Producto Perfiletto En Extraordinario

MAYORES GANANCIAS
utilizando contramarco sin venas



Armado Horizontal Superior

Armado hoja fija

MÁS RÁPIDO

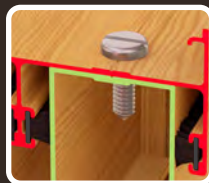

Vista Distinguida y Más Económica

Cerco Fijo da Apariencia de un Perfil Integrado al Contramarco



Más Acercamiento de Felpas logrando **MAYOR HERMETICIDAD**



Atornille una sola vez los Traslapes, Acristale en Mesa Hojas Fija y Corrediza



Colocación Rápida de Hoja Corrediza y Hoja Fija Con Atornillado por el Exterior, en Zoclo y Cabezal

Pijas sin Contacto con el Cristal



MAYOR ACERCAMIENTO de Felpa con Zoclo

Zoclo de Hoja Fija con Mayor Resistencia ante Ráfagas de Viento



ATORNILLAR POR FUERA

Vinil Hongo en Traslapes Aumenta Hermeticidad a: Polvo, Ruido y Viento

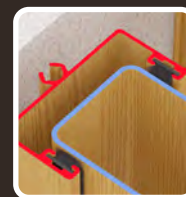

Ofrece la Experiencia de un Cierre Suave y Silencioso

Por Cerco con Esquinas Curvas y Contacto de Felpas al 100%

Fijación Invisible con Moldura de Fijación a Muro

Cubiertas Traslapes



Maximiza la Hermeticidad a Viento y Polvo, entre Traslapes, Contramarco y Riel hasta un **85%**

Descubre otras Opciones para tu Cancelería



Zoclo Puerta



Mosquitero Horizontal Doble Vena

■ Aislamiento Acústico 67848 39.5 Decibles

■ Permeabilidad a Viento y Polvo 67848 Aire que Detiene 91 %

■ Resistencia A Vientos Sin Deformar el Perfil Ventana 120 Km/h Puerta 110 Km/h

AISLAMIENTO ACÚSTICO
REALIZADO CON 120 DECIBELES AL EXTERIOR
MEDIDA 1.00 x 1.00 m

TRASLAPE 67848

DIVISIÓN TEXTIL 7 mm
Clave: FL6 Comercial
VH4 Vinil Hongo
VC11 Ambos lados

39.5 Decibeles



LÍNEA EXCLUSIVA PERFILETTO

PERMEABILIDAD AL AGUA DURANTE 20 MINUTOS

VENTANA MEDIDA 1.00 x 1.00 m

VELOCIDAD KM/H	Agua	Aire
20	50%	50%
40	50%	50%
60	50%	50%
80	50%	50%
100	50%	50%
120	60%	40%

SIN MOSQUITERO
Sin Filtraciones

MOSQUITERO FIJO 7336
Sin Filtraciones

MOSQUITERO CORREDIZO INTERIOR 6533 y 6534
Sin Filtraciones

VELOCIDAD KM/H	Agua	Aire	Litros Filtrados
20	50%	50%	1.21
40	50%	50%	1.49
60	50%	50%	1.62
80	50%	50%	1.65
100	50%	50%	1.70
120	60%	40%	1.78

MOSQUITERO CORREDIZO EXTERIOR 66533 y 66534
MOSQUITERO CORREDIZO EXTERIOR OCASIONA ALTA FILTRACIÓN DE AGUA

Otros Mosquiteros Fijos Ocasionan Filtraciones Por su Altura Mayor Respecto al Riel

PUERTA MEDIDA 1.00 x 1.00 m

VELOCIDAD KM/H	Agua	Aire
20	50%	50%
40	50%	50%
60	50%	50%
80	50%	50%
100	50%	50%
120	60%	40%

SIN MOSQUITERO
Sin Filtraciones

MOSQUITERO CORREDIZO INTERIOR 6533 y 6534
Sin Filtraciones

VELOCIDAD KM/H	Agua	Aire	Litros Filtrados
20	50%	50%	1.23
40	50%	50%	1.53
60	50%	50%	1.65
80	50%	50%	1.69
100	50%	50%	1.73
120	60%	40%	1.80

MOSQUITERO CORREDIZO EXTERIOR 66533 y 66534
MOSQUITERO CORREDIZO EXTERIOR OCASIONA ALTA FILTRACIÓN DE AGUA

PERMEABILIDAD AL VIENTO Medida 1.00 x 1.00 m

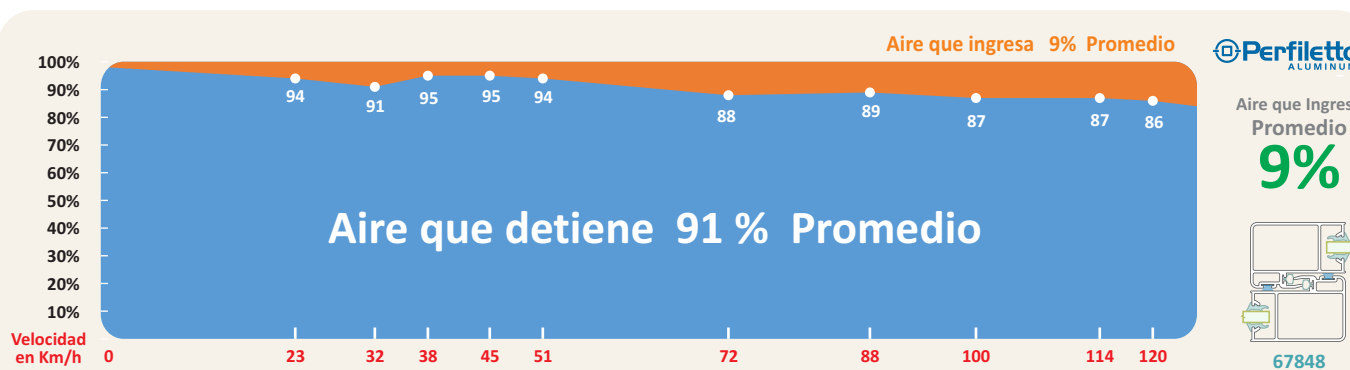

LÍNEA EXCLUSIVA PERFILETTO

RESISTENCIAS A VIENTOS

VENTANA
Prueba Realizada
30 Repeticiones de 1 Minuto c/u
A 120 Km/h
Medida 1.00 x 1.00 m
Cristal 6 mm
LOS PERFILES SIN DEFORMACIÓN
CONSERVAN SU FUNCIONAMIENTO

PUERTA
Prueba Realizada
30 Repeticiones de 1 Minuto c/u
A 110 Km/h
Medida 2.00 X 2.10 m
Cristal 6 mm
LOS PERFILES SIN DEFORMACIÓN
CONSERVAN SU FUNCIONAMIENTO

Ruptura de Cristal a 120 km/h

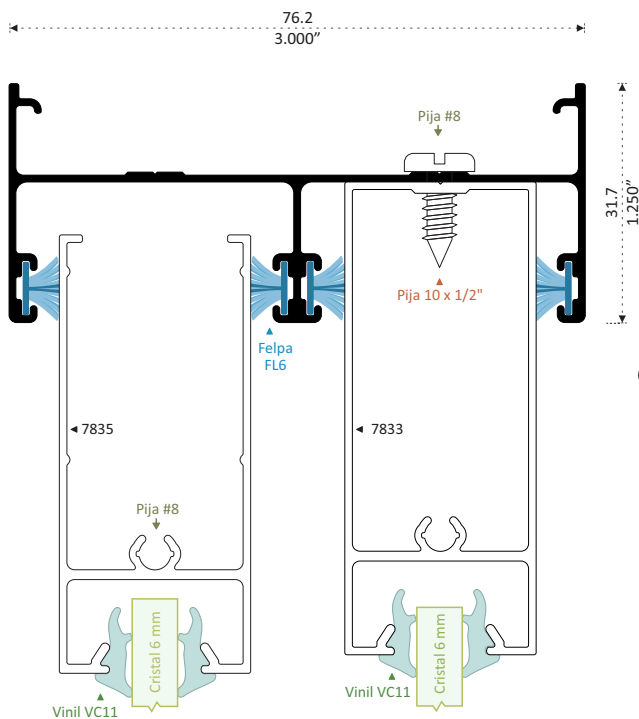

S67826
CONTRAMARCO
HORIZONTAL
SIN VENAS
Longitud 6.10 m

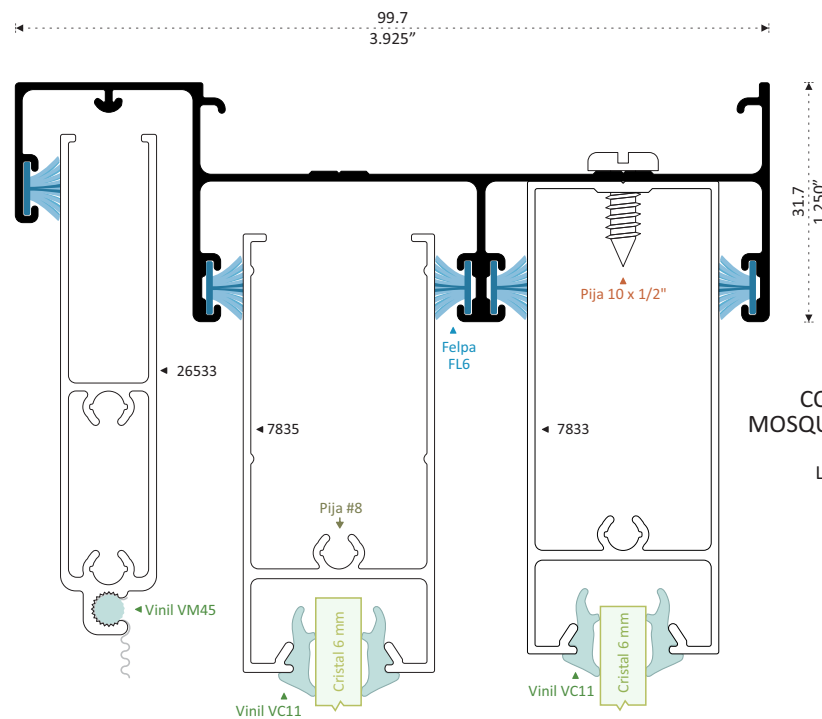

S67862
CONTRAMARCO
MOSQUITERO CORREDIZO
SIN VENAS
Longitud 6.10 m

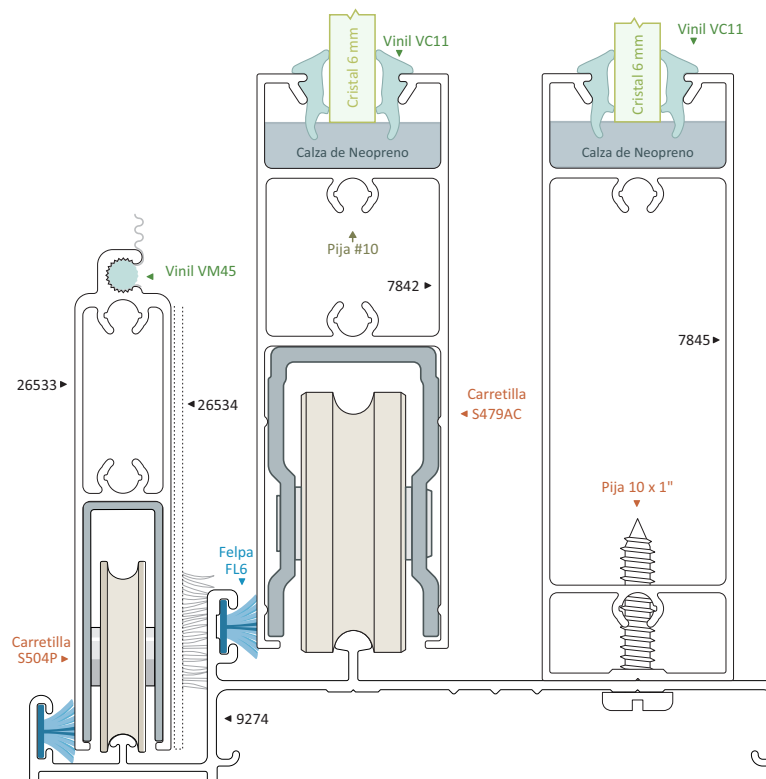
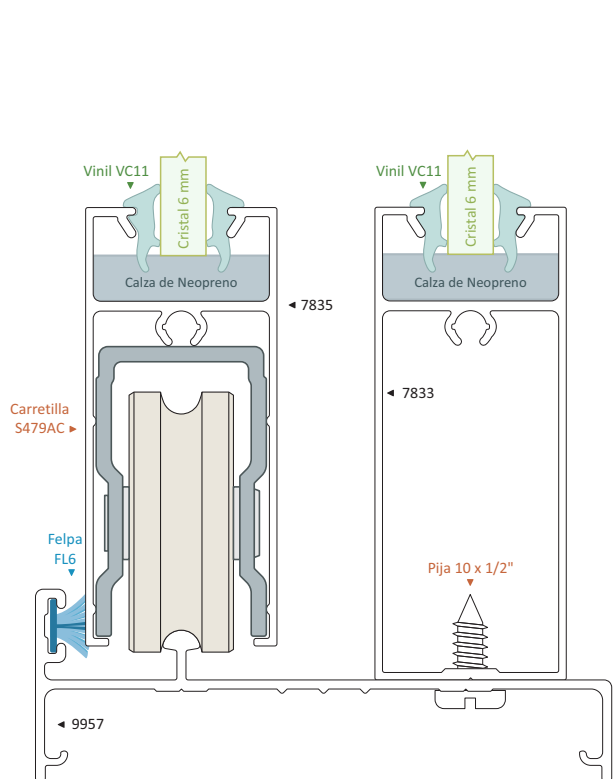

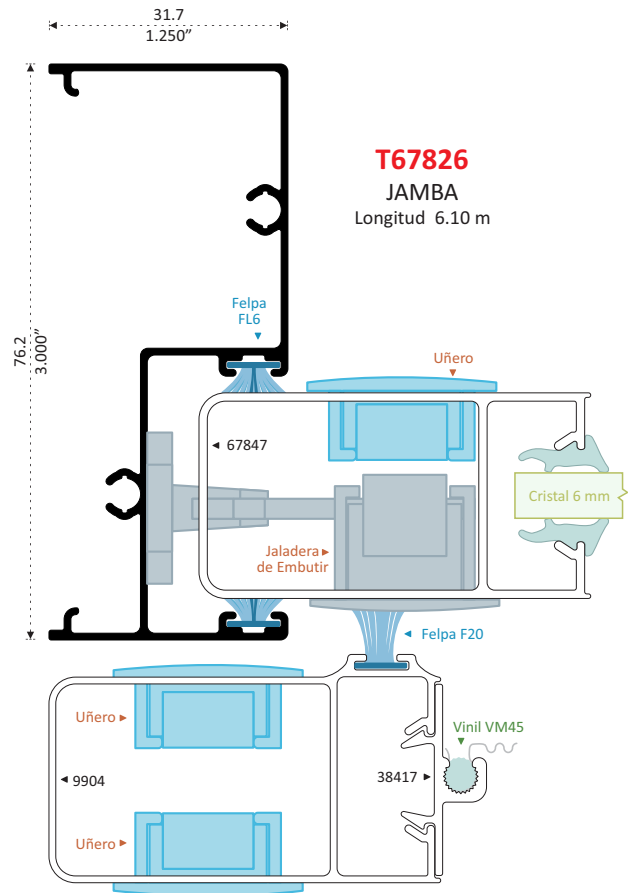

67848 PATENTE
TRASLAPE
Longitud 4.60 m
67848-5.1 5.10 m
67848-L 6.10 m

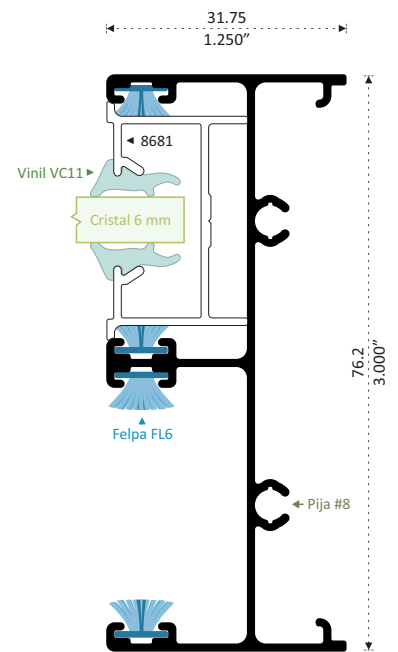
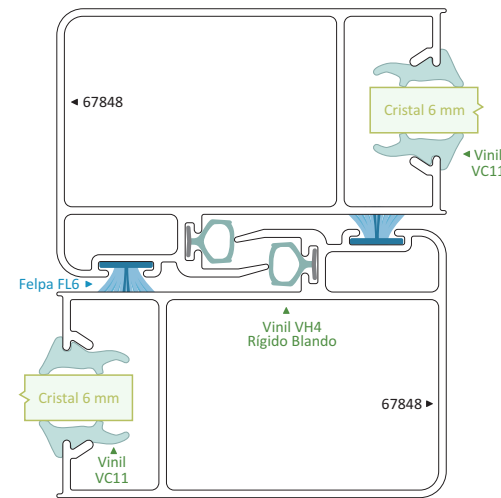
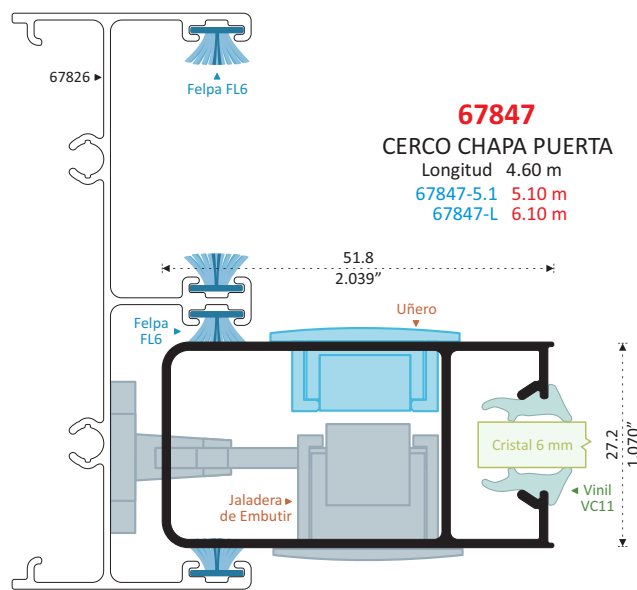
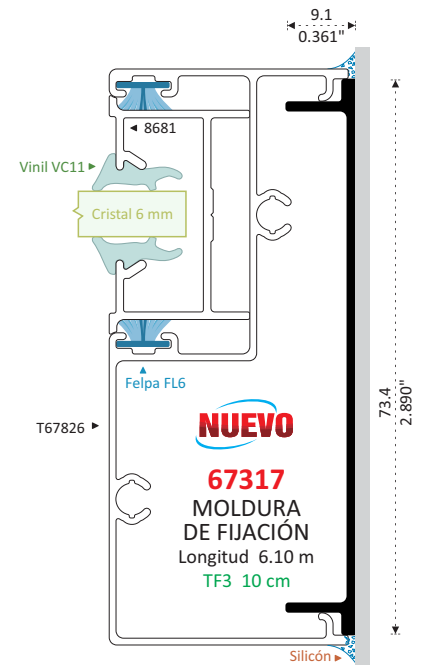
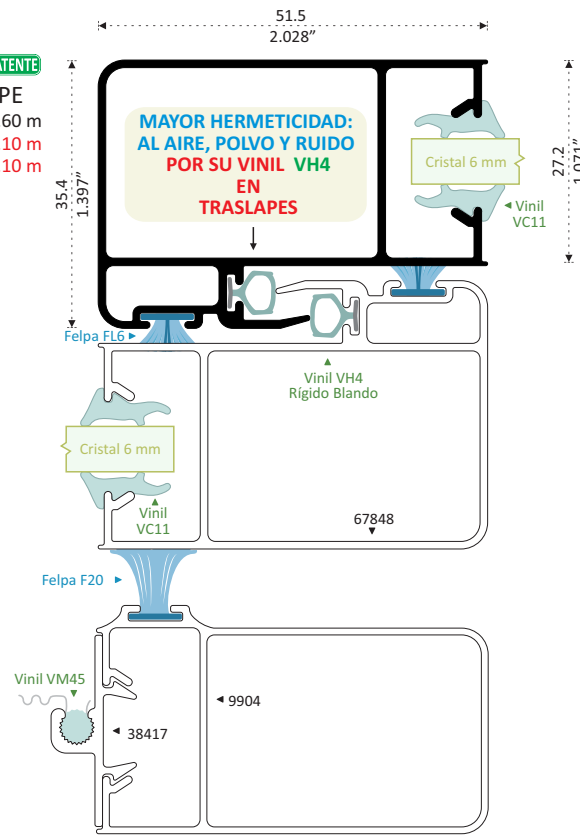

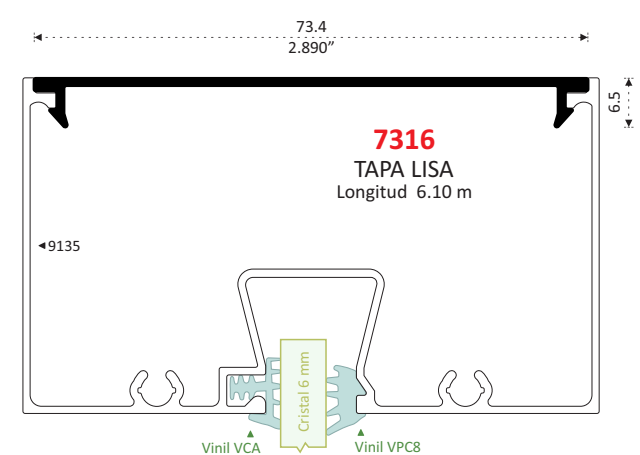
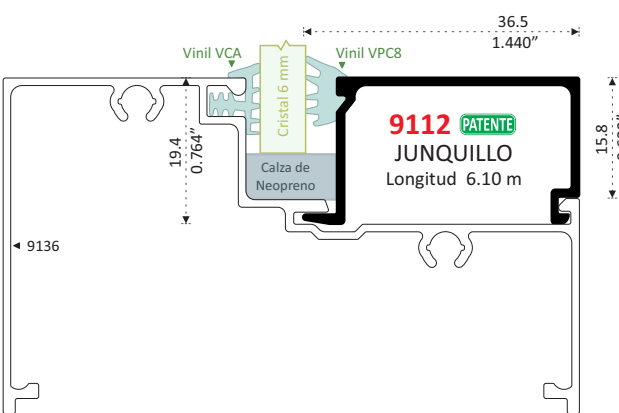
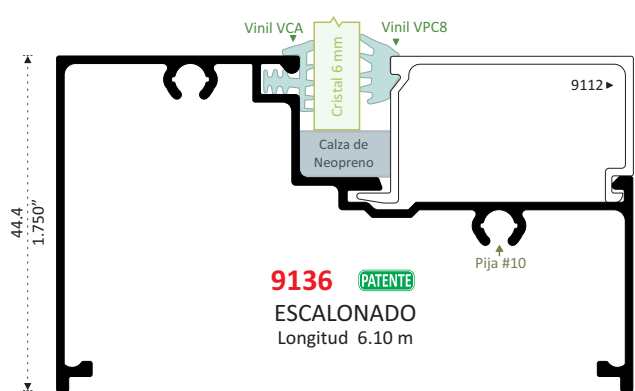
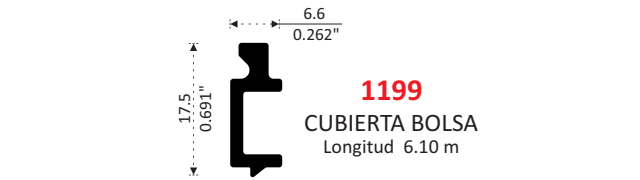
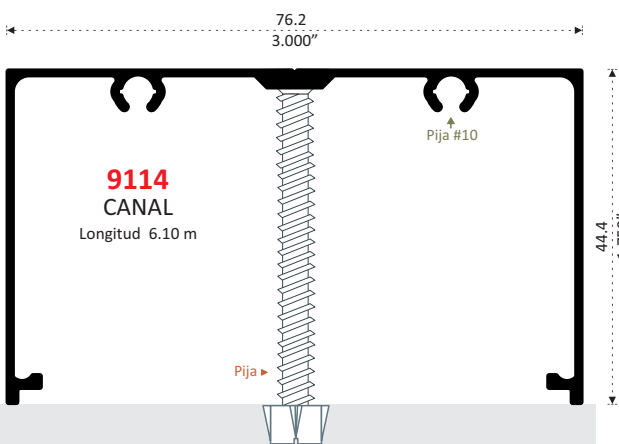
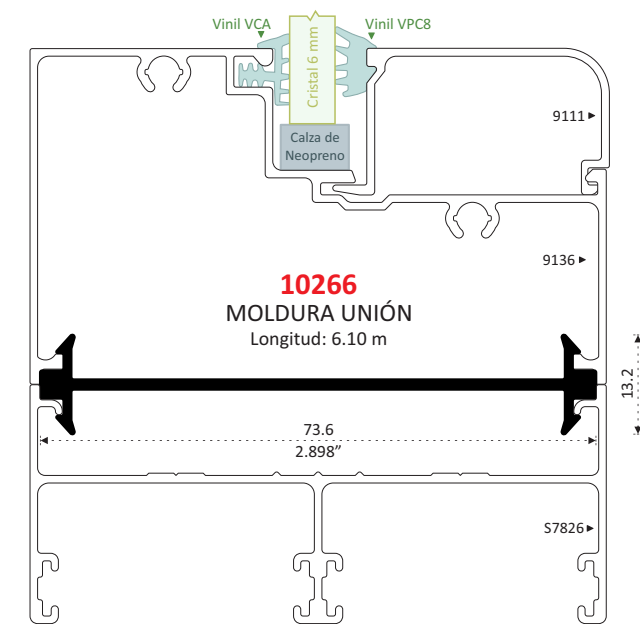
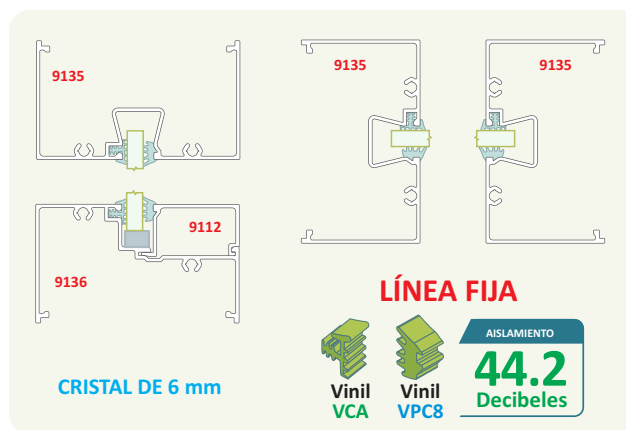
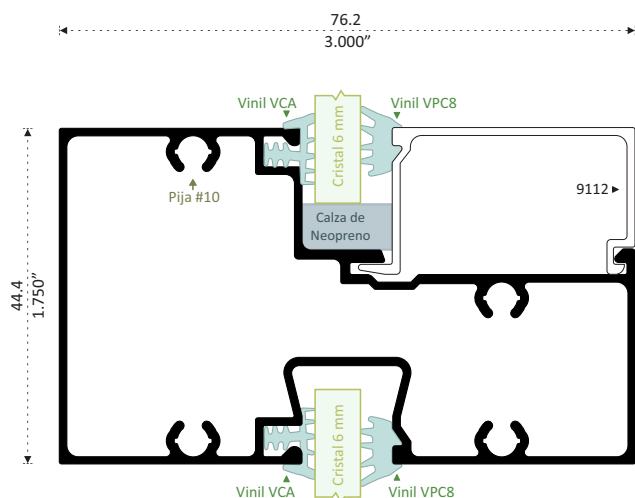
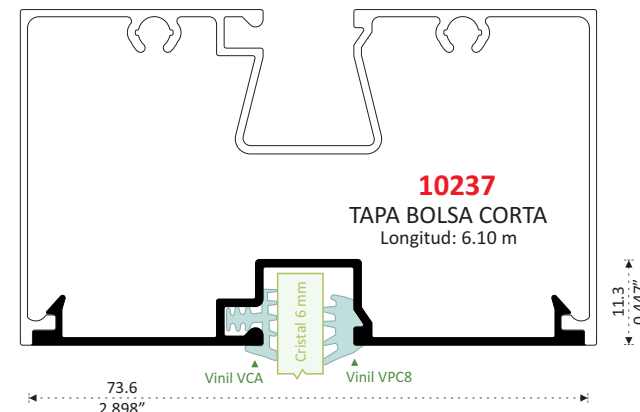
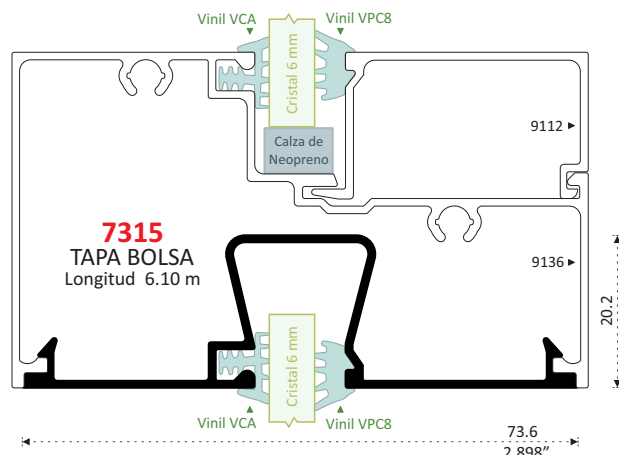
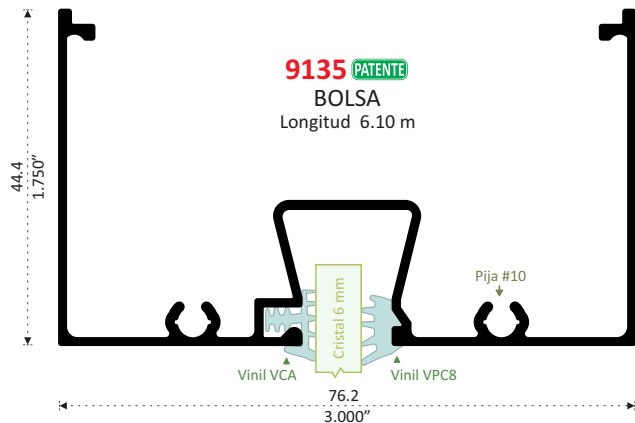

Perfil Cerrado 4 Venas
Mayor Resistencia
Armado Horizontal "ó" Vertical

9105
BOLSA CORTA
TEMPLE T1
Longitud: 6.10 m

**PERFIL ESPECIAL
PARA ROLAR**

Es Alterado El Temple T1,
durante el Proceso de
Pintura Electrostática

10235
BOLSA CORTA
Longitud: 6.10 m

9115
ESQUINERO
Longitud: 6.10 m

9138 PATENTE
ESQUINERO REGULABLE
Longitud: 6.10 m
9138-C 3.05 m

9137 PATENTE
ESQUINERO REGULABLE
Longitud: 6.10 m
9137-C 3.05 m

Ajustable
Hasta 139°

LÍNEA 3" COMERCIAL HERMÉTICA

Convierte un Producto Perfiletto En Extraordinario

MAYORES GANANCIAS
utilizando contramarco sin venas



Armado Horizontal Superior

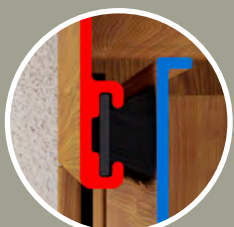

Más Acercamiento de Felpas logrando **MAYOR HERMETICIDAD**

MAYOR ACERCAMIENTO de Felpa con Zoclo



Sellado entre Riel y Jambas con Juntas de Estanqueidad

Riel con Inclinación

Evite Filtraciones de Agua y Humedades a Muros



Atornillado de hoja fija

MÁS RÁPIDO



Atornille una sola vez los Traslapes, Acristale en Mesa Hojas Fija y Corrediza



Colocación Rápida de Hoja Corrediza y Hoja Fija **Con Atornillado por el Exterior, en Zoclo y Cabezal**

Pijas sin Contacto con el Cristal

Zoclo de Hoja Fija con Mayor Resistencia ante Ráfagas de Viento



ATORNILLAR POR FUERA

Optimiza tus Compras Perfiles con Diferentes Longitudes

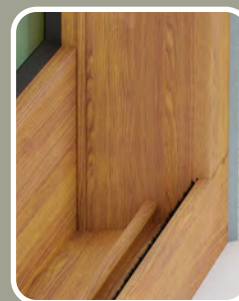

Vista Distinguida y Más Económica

Vinil Hongo en Traslapes Aumenta Hermeticidad a: **Polvo, Ruido y Viento**

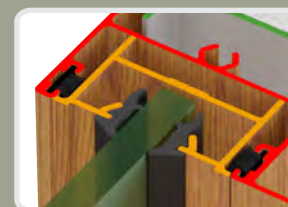

Instalado da Apariencia de un Perfil Integrado al Contramarco

Fijación Invisible con Moldura de Fijación a Muro

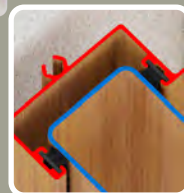

Ofrece la Experiencia de un Cierre Suave y Silencioso

Por Cerco con Esquinas Curvas y Contacto de Felpas al 100%

Cubiertas Traslapes

Maximiza la Hermeticidad a Viento y Polvo, entre Traslapes, Contramarco y Riel hasta un **85%**



Descubre otras Opciones para tu Cancelería

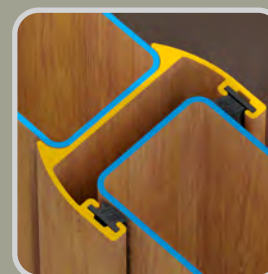

Adaptador Cierre al Centro 2 Hojas

Excelente vista por su Cierre al Centro

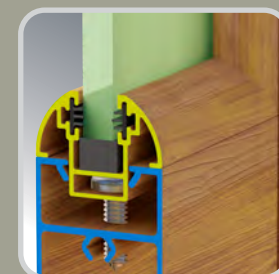

Adaptador Curvo

Mejor Vista por sus vinilos ocultos

■ Aislamiento Acústico 7848 40.3 Decibles

■ Permeabilidad a Viento y Polvo 7848 Aire que Detiene 93 %

■ Resistencia A Vientos Sin Deformar el Perfil Ventana 120 Km/h Puerta 110 Km/h

AISLAMIENTO ACÚSTICO
REALIZADO CON 120 DECIBELAS AL EXTERIOR
MEDIDA 1.00 x 1.00 m

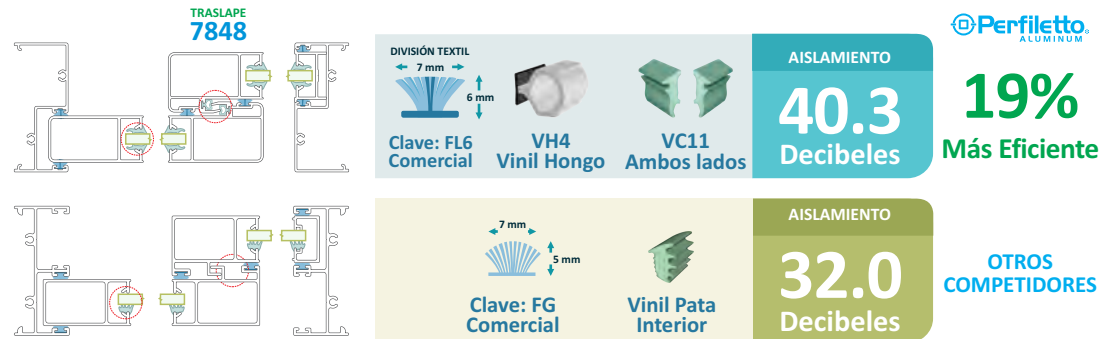

PERMEABILIDAD AL AGUA DURANTE 20 MINUTOS



PERMEABILIDAD AL VIENTO Medida 1.00 x 1.00 m

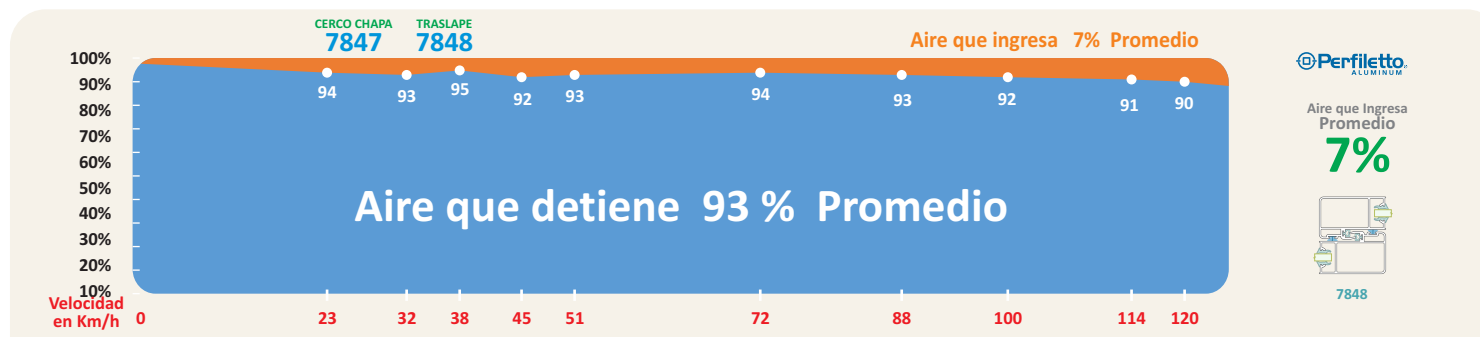

OTROS COMPETIDORES

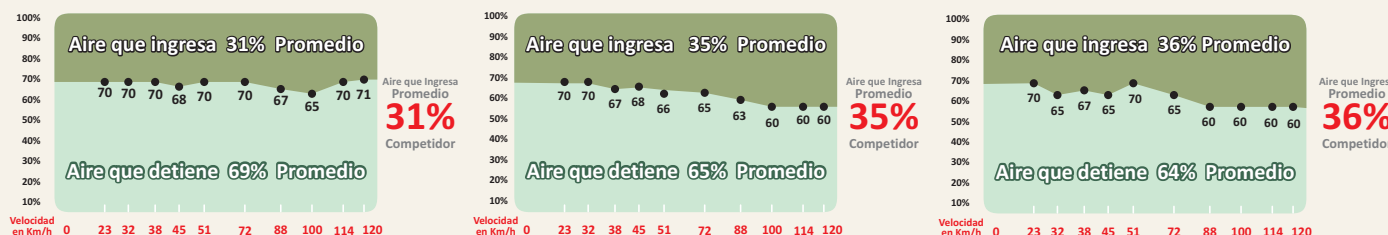

RESISTENCIAS A VIENTOS



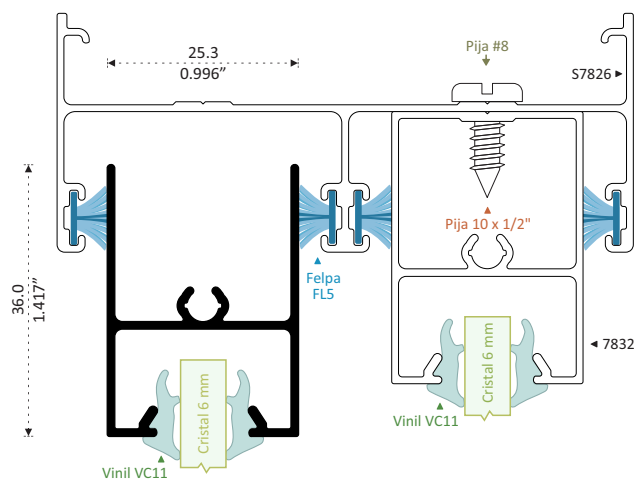
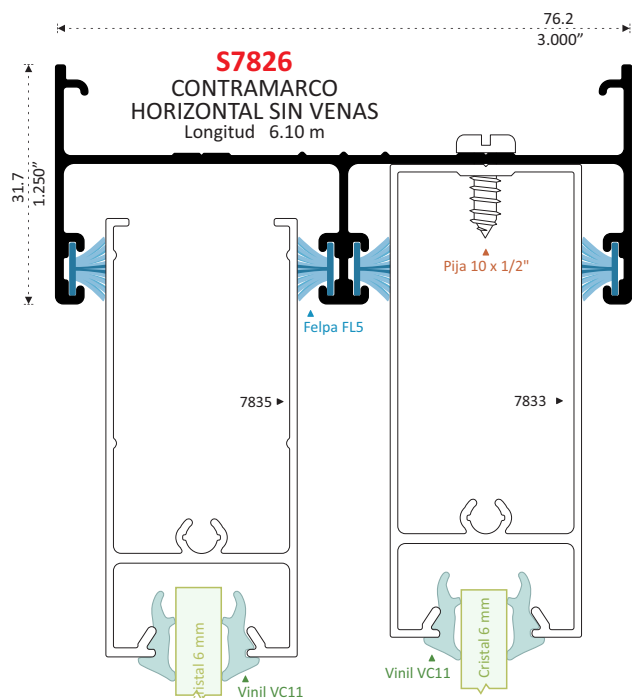

7836
CABEZAL
Longitud 6.10 m

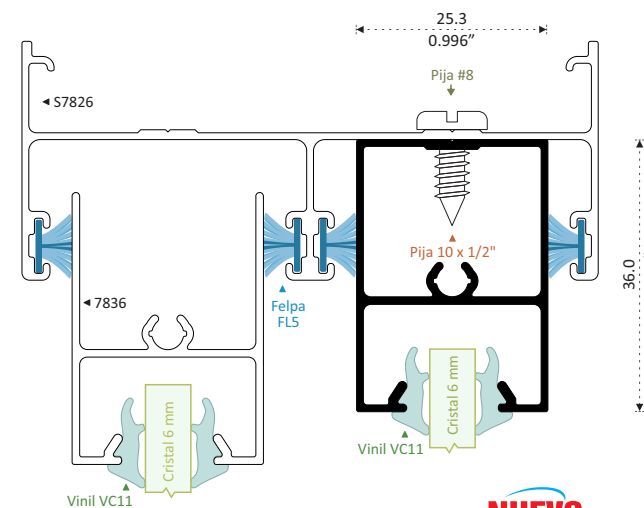

NUEVO

7832
CABEZAL FIJO
Longitud 6.10 m
7832-C 3.05 m

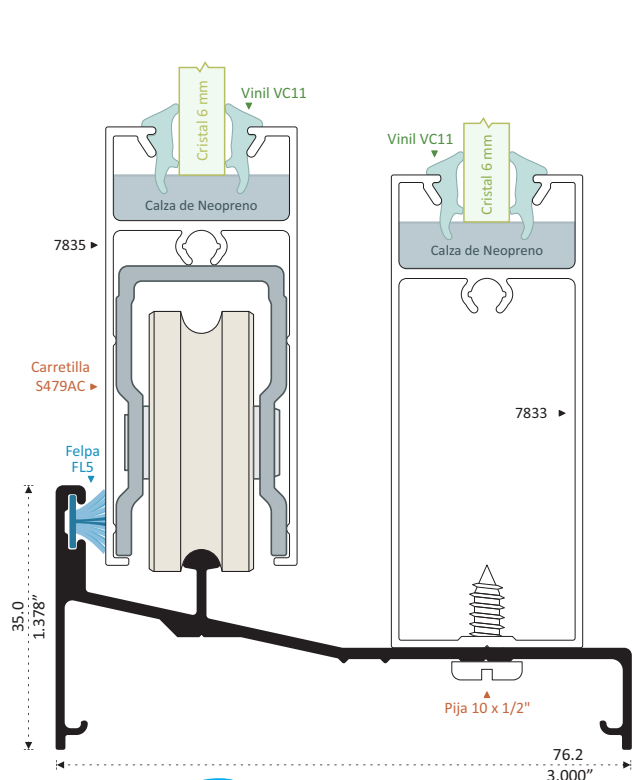

NUEVO i9957
RIEL 3" CON INCLINACIÓN
Longitud 6.10 m

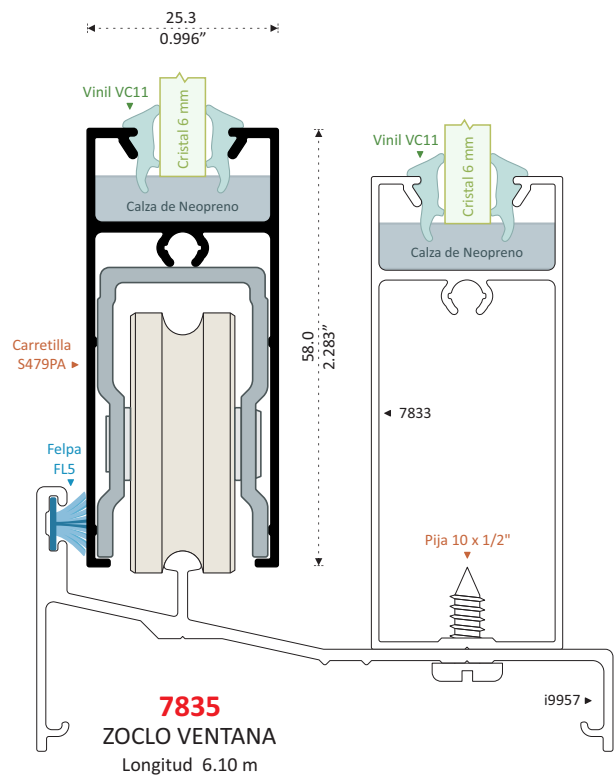

7835
ZOCLO VENTANA
Longitud 6.10 m

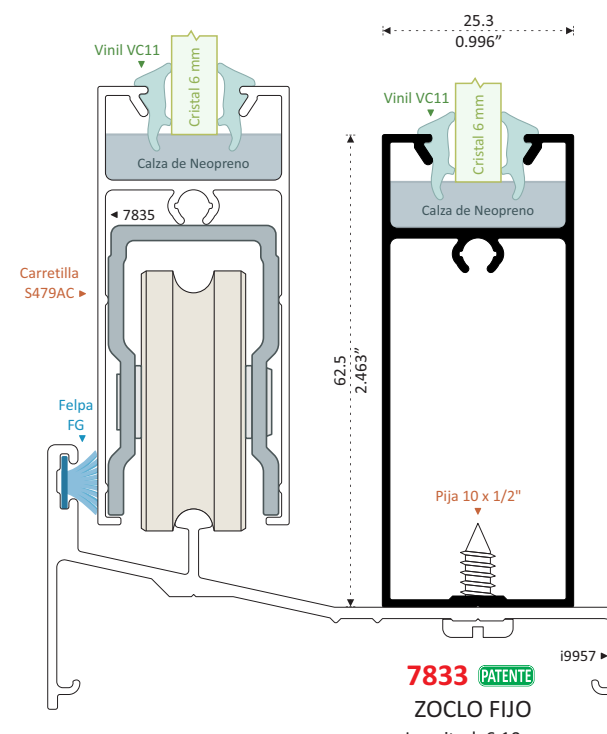

7833 PATENTE
ZOCLO FIJO
Longitud 6.10 m
7833-C 3.05 m

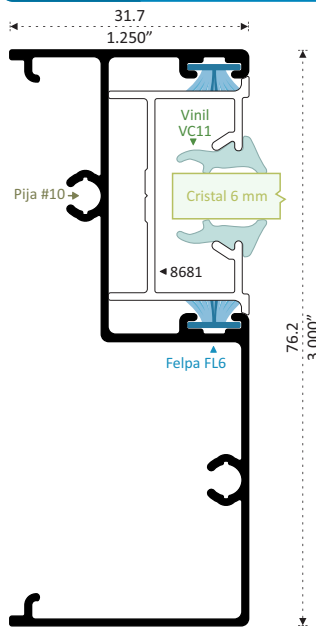

T7826 PATENTE
JAMBA
Longitud 6.10 m

**MAYOR HERMETICIDAD:
AL AIRE, POLVO Y RUIDO
POR SU VINIL VH4
EN
TRASLAPES**

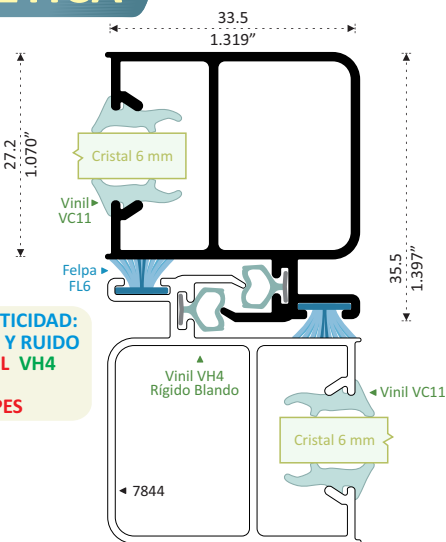

NUEVO
7844 PATENTE
TRASLAPE
Longitud 6.10 m

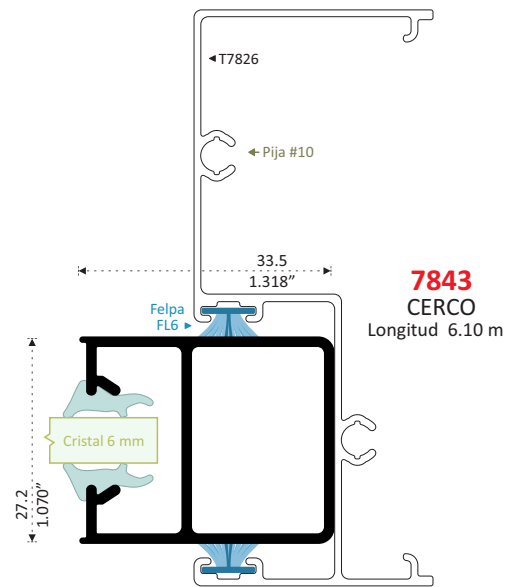

7843
CERCO
Longitud 6.10 m

**Logrando Mayor
Hermeticidad al Viento y Polvo**

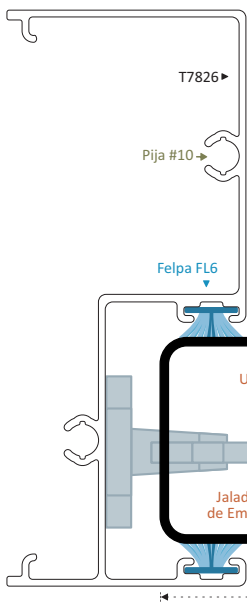

7847
CERCO CHAPA
Longitud 4.60 m
7847-5.1 5.10 m
7847-L 6.10 m

NUEVO

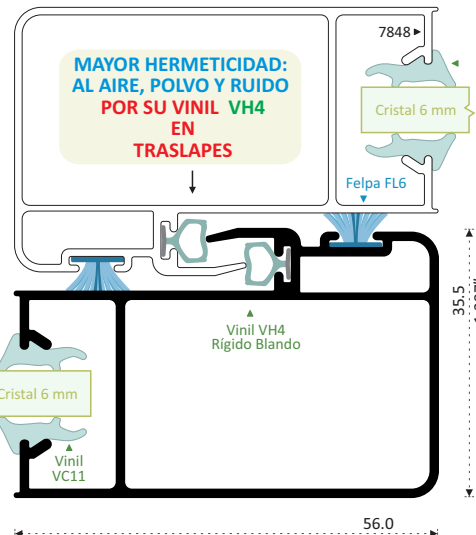

NUEVO
7848 PATENTE
TRASLAPE
Longitud 4.60 m
7848-5.1 5.10 m
7848-L 6.10 m



NUEVO
8681 PATENTE
CERCO FIJO
Longitud 6.10 m

NUEVO
67317
MOLDURA
DE FIJACIÓN
Longitud 6.10 m
TF3 10 cm

Mayor Tamaño y Vista en Cerco Chapa y Traslape

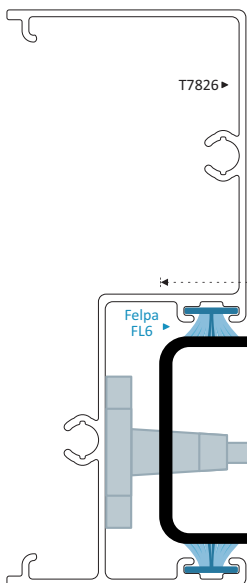

17847
CERCO CHAPA GRAN VISTA
Longitud 6.10 m
17847-C 4.60 m

**MAYOR HERMETICIDAD
POR SU VINIL VH4
EN
TRASLAPES**

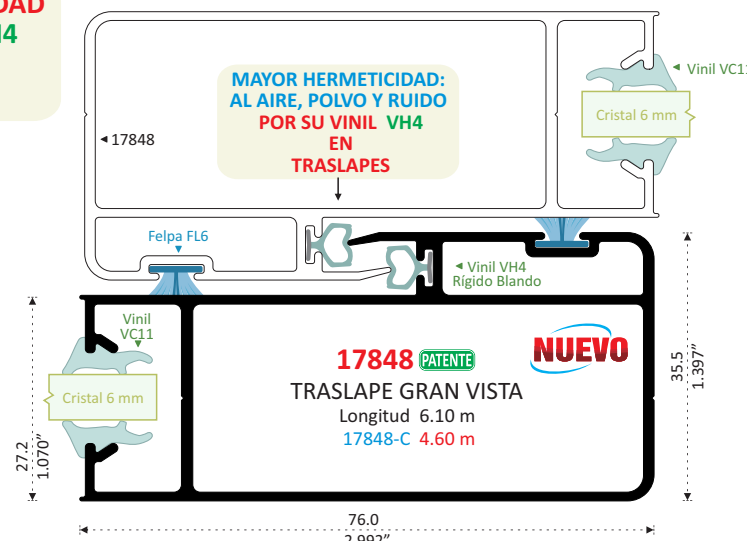

17848 PATENTE
TRASLAPE GRAN VISTA
Longitud 6.10 m
17848-C 4.60 m

NUEVO

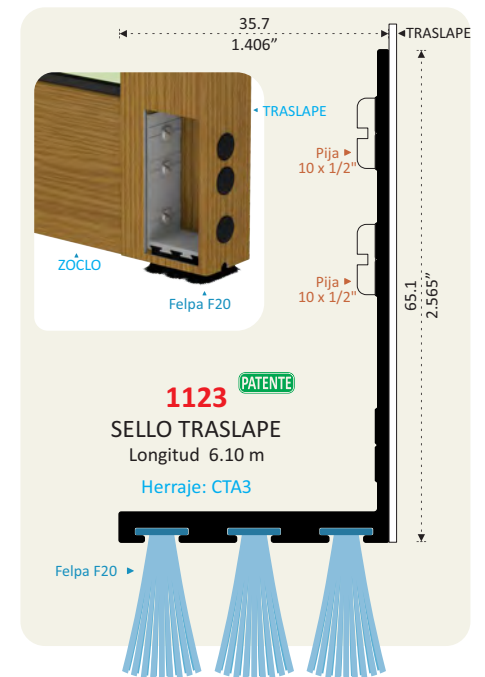

1123 PATENTE
SELLO TRASLAPE
Longitud 6.10 m
Herraje: CTA3

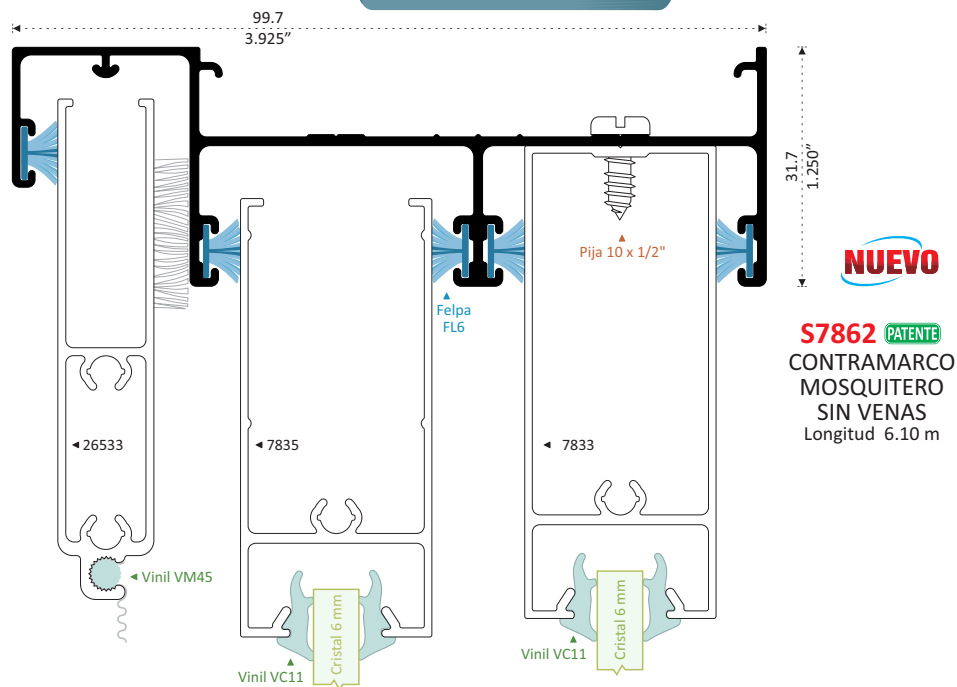

NUEVO

7837 PATENTE
INTERMEDIO
Longitud 6.10 m
7837-C 3.05 m
IPF 0.87 m

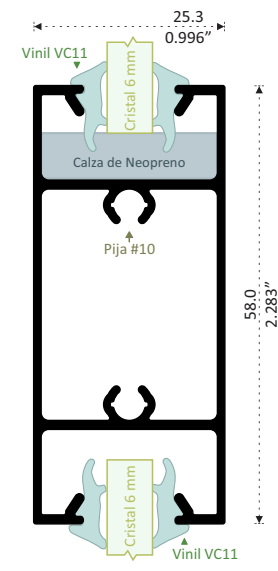

9082
INTERMEDIO
Longitud 6.10 m

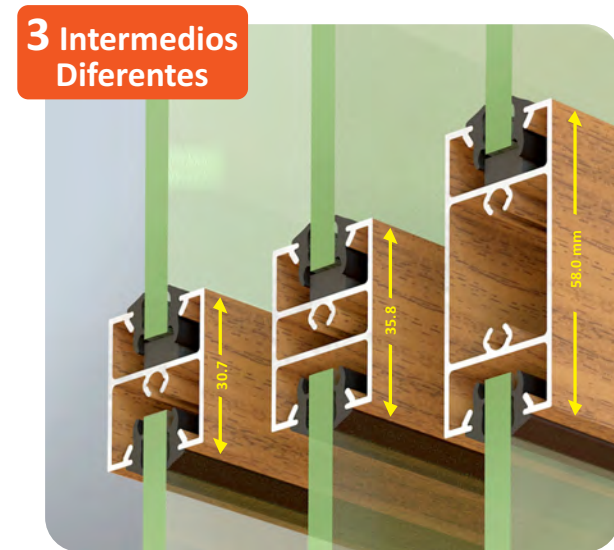

69082
INTERMEDIO
Longitud 6.10 m

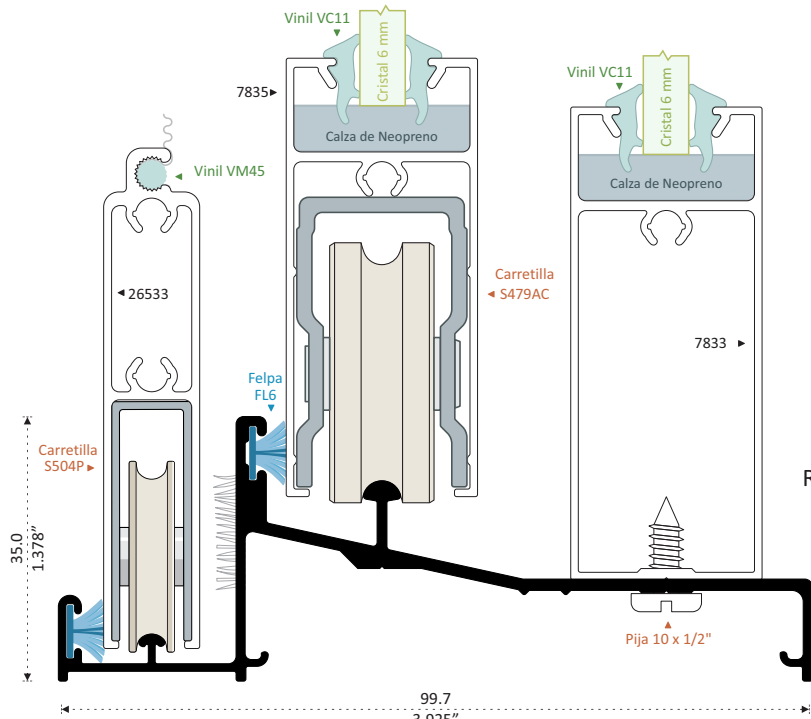
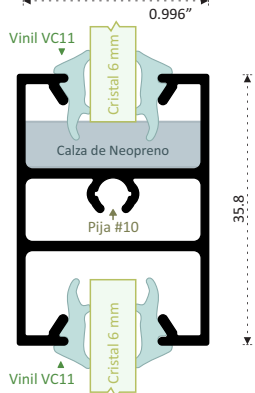
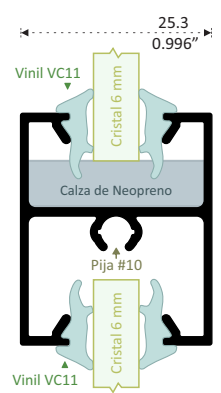

NUEVO

i9274 PATENTE
RIEL MOSQUITERO
INTERIOR
Longitud 6.10 m

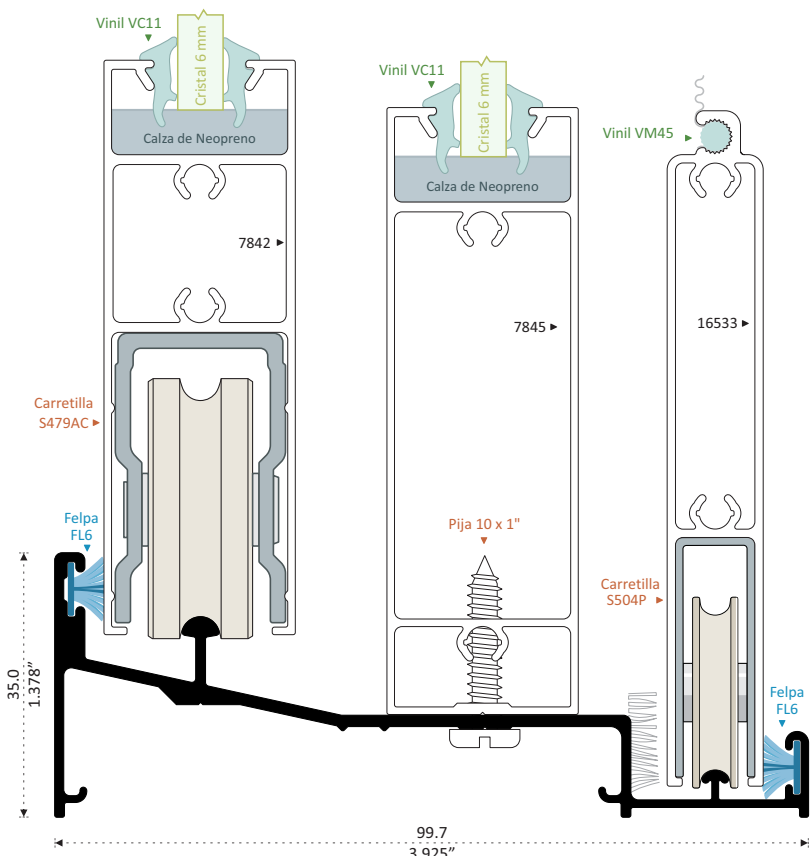

NUEVO

i9274 PATENTE
RIEL MOSQUITERO
EXTERIOR
Longitud 6.10 m

ARMADO MÁS RÁPIDO



**Colocación Rápida
de Hoja Corrediza
y Hoja Fija
Con Atornillado
por el Exterior,
en Zoclo y Cabezal**

**Atornille una sola vez
los Traslapes,
Acrístale en Mesa
Hojas Fija y Corrediza**

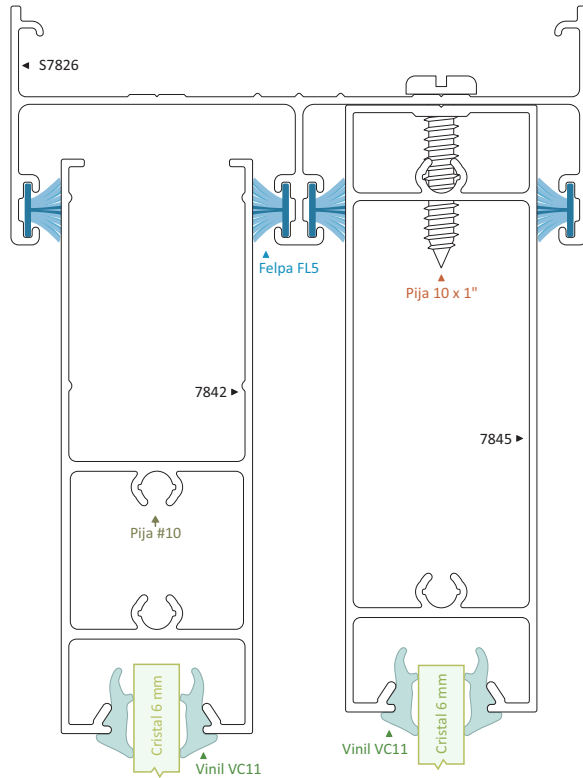

7840
ZOCLO
PUERTA 5"
Longitud 6.10 m

25.3
0.996"

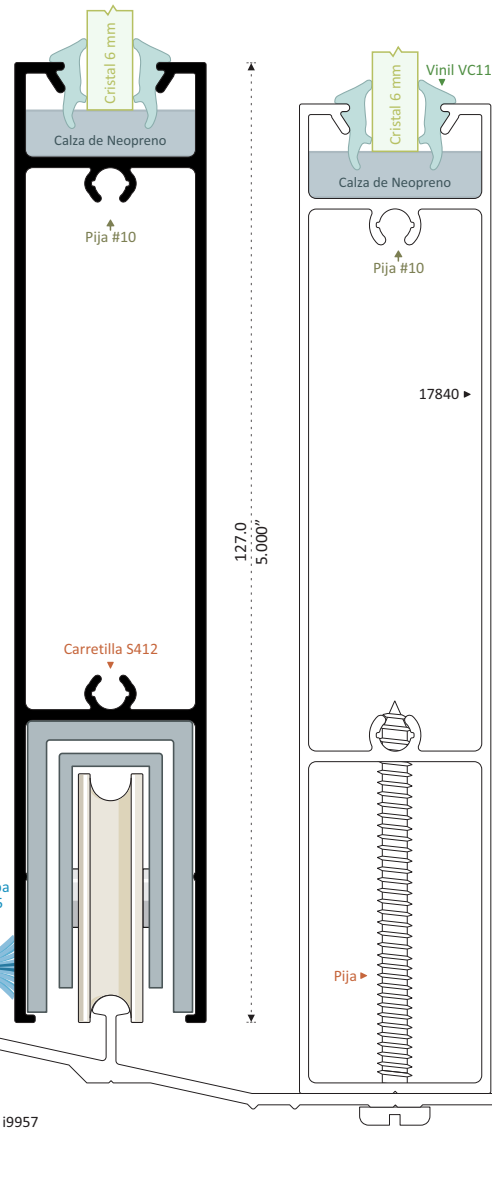

17840
ZOCLO FIJO 5"
Longitud 6.10 m

25.3
0.996"

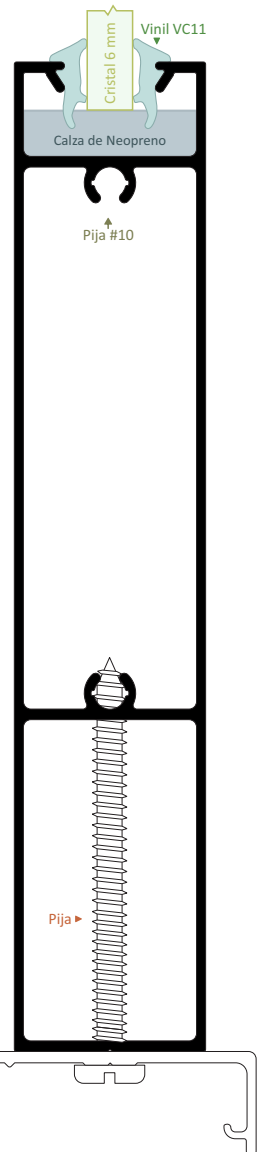

7842
ZOCLO PUERTA
Longitud 6.10 m

25.3
0.996"

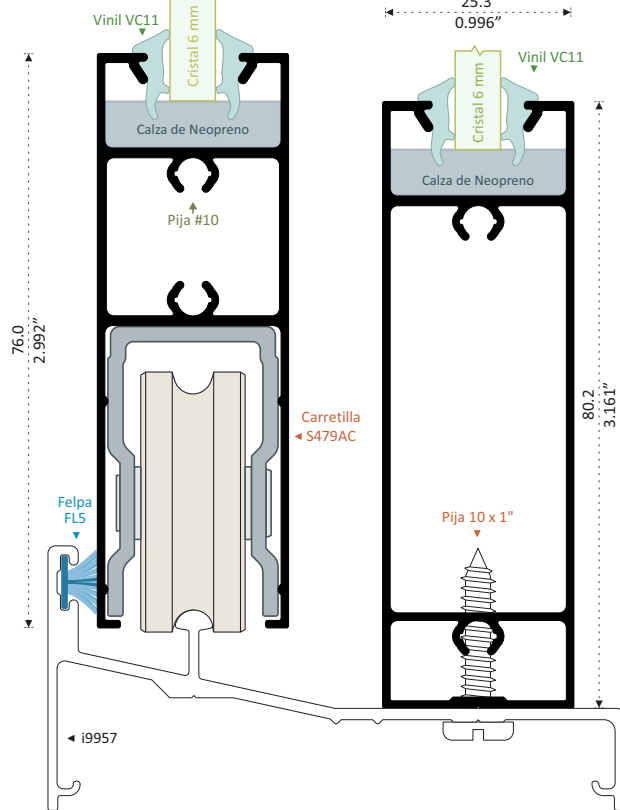

7845
ZOCLO CON BASE
Longitud 6.10 m

25.3
0.996"

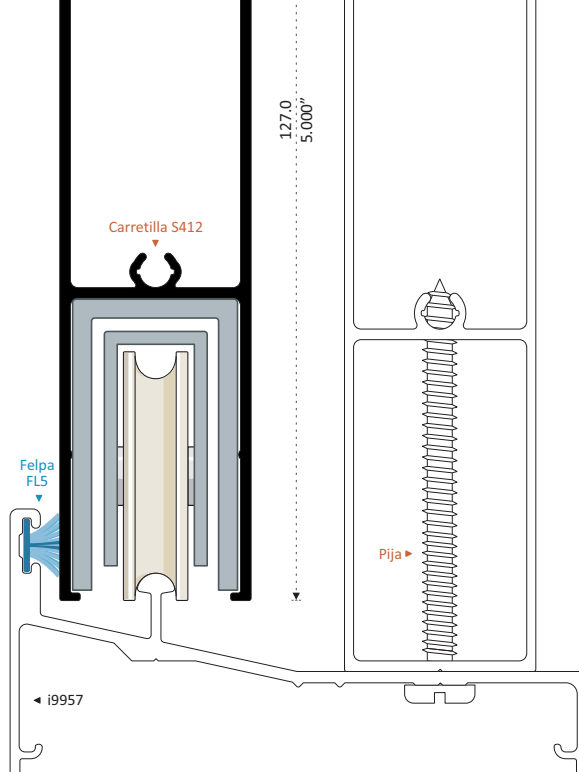

CUATRO OPCIONES MOSQUITERO CORREDIZO

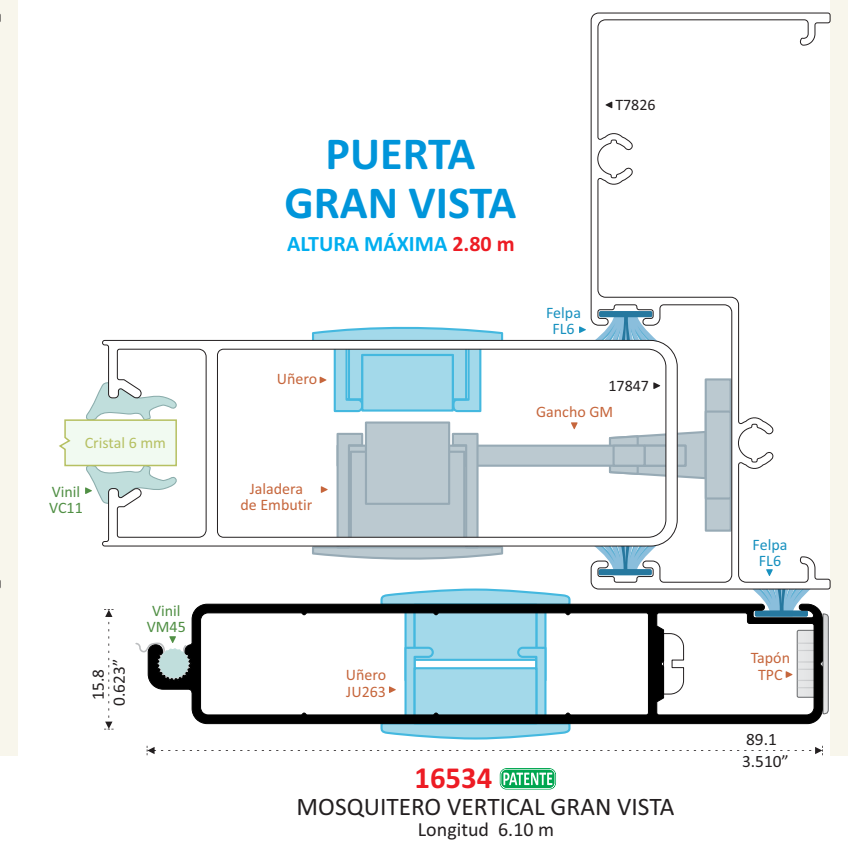
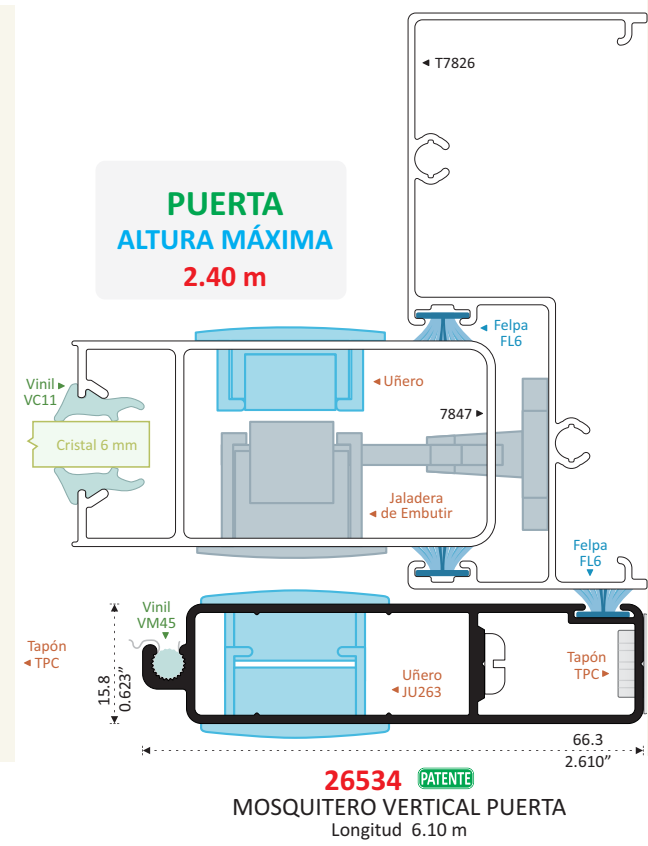
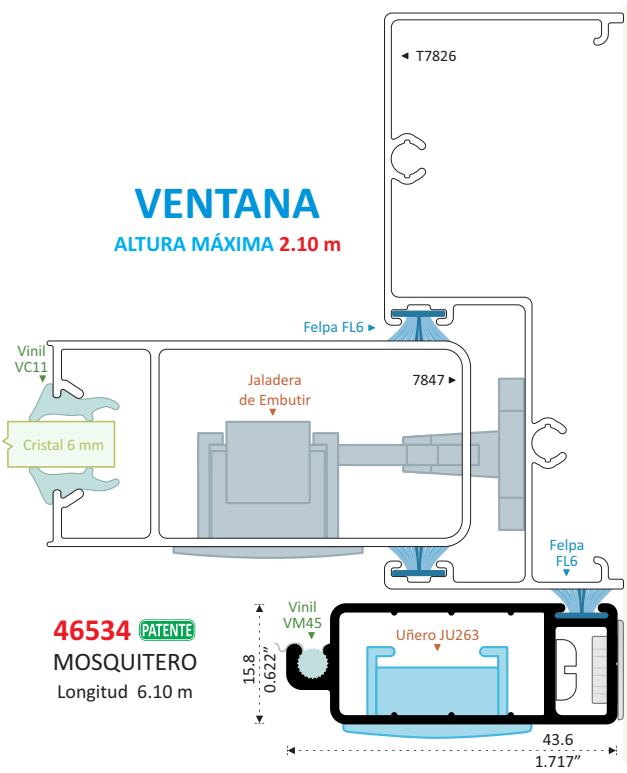
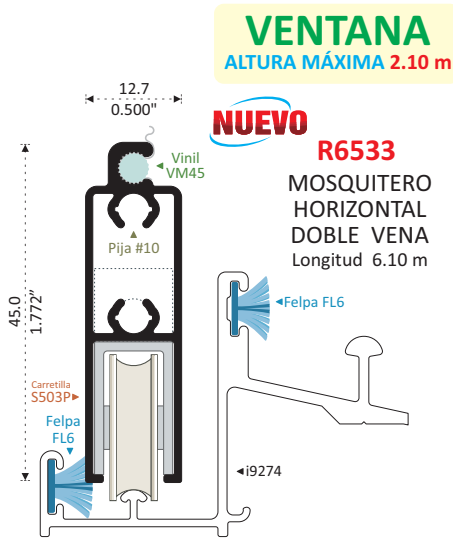
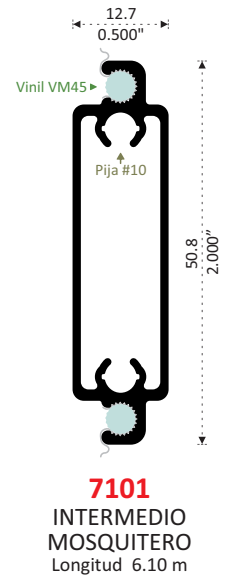
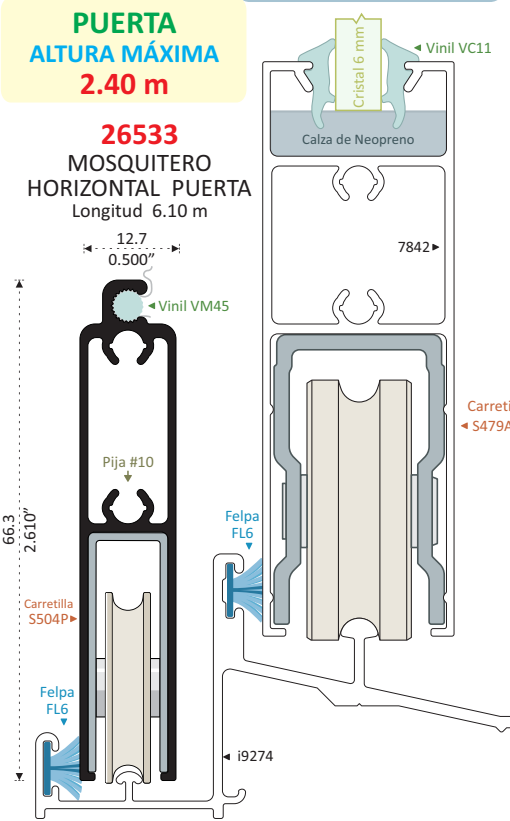
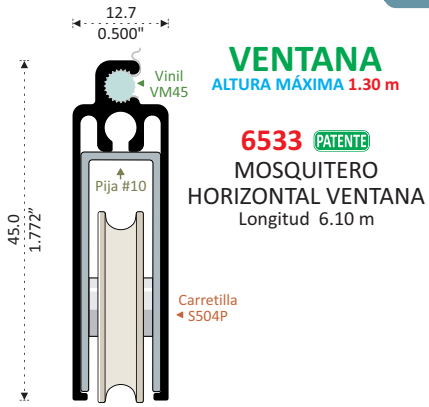

10220
ADAPTADOR
Longitud 6.10 m

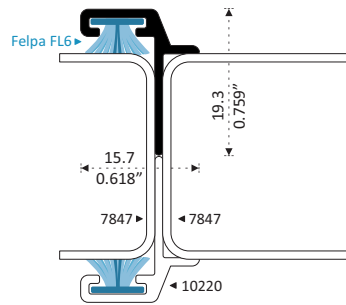

7851 PATENTE
ADAPTADOR
Longitud 6.10 m
7851-C 3.05 m

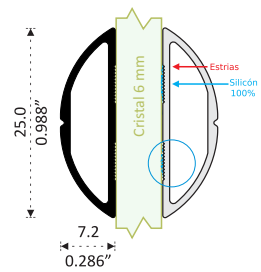
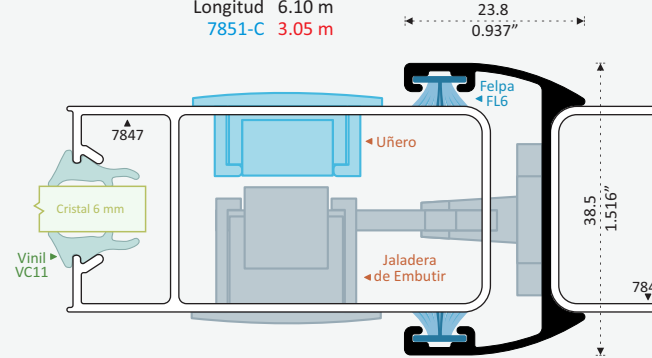

8272
MARQUETERÍA
EXPUESTA
CURVA
Longitud 6.10 m

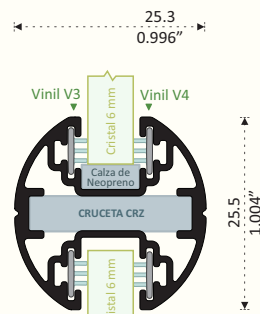

8271 PATENTE
INTERMEDIO CURVO
Longitud 6.10 m

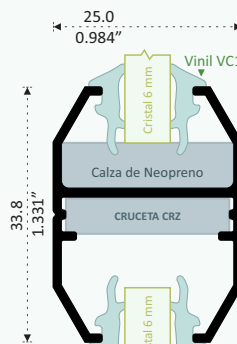

614918
INTERMEDIO
BISELADO
Longitud 6.10 m

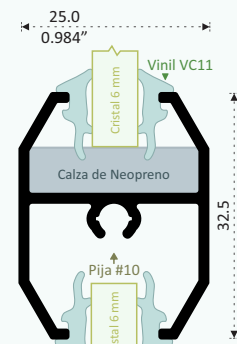

14918
INTERMEDIO
BISELADO
Longitud 6.10 m

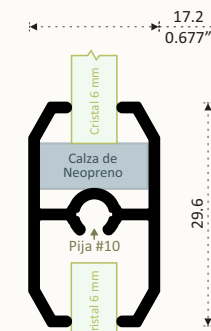

12394
BARROTILLO
Longitud 6.10 m

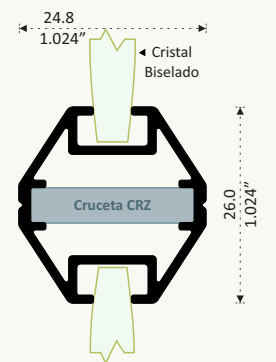

8267 PATENTE
INTERMEDIO BISELADO
Longitud 6.10 m

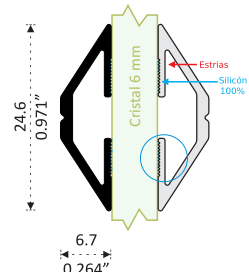

8264
MARQUETERÍA
EXPUESTA
BISELADA
Longitud 6.10 m

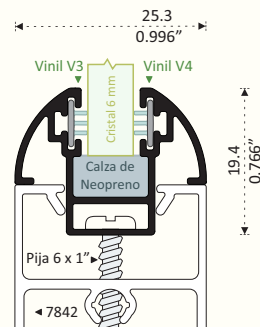

8269
ADAPTADOR CURVO
Longitud 6.10 m

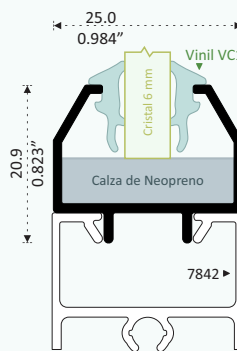

614702
ADAPTADOR
BISELADO
Longitud 6.10 m

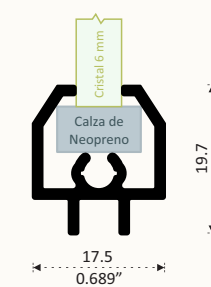

12395
RESERCADO
Longitud 6.10 m

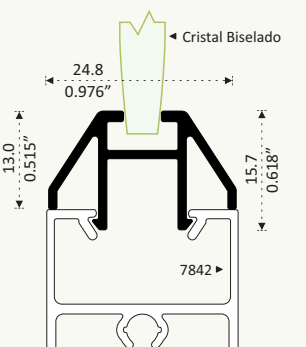

8265 PATENTE
ADAPTADOR BISELADO
Longitud 6.10 m

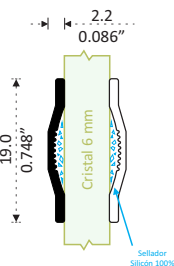

81642
CUADRÍCULA
EXPUESTA
Longitud 6.10 m



VINIL
OCULTO

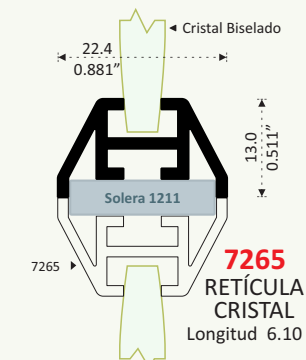

7265
RETÍCULA
CRISTAL
Longitud 6.10 m

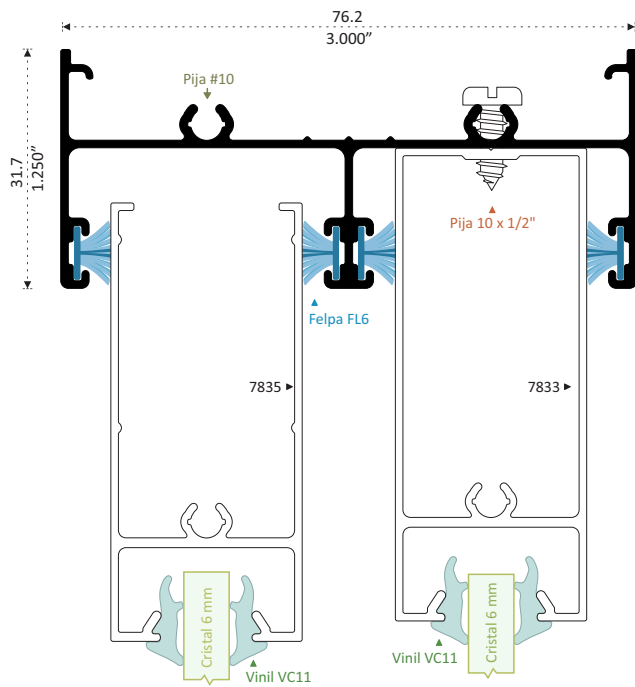

7826
CONTRAMARCO
Longitud 6.10 m
7826-C 4.60 m

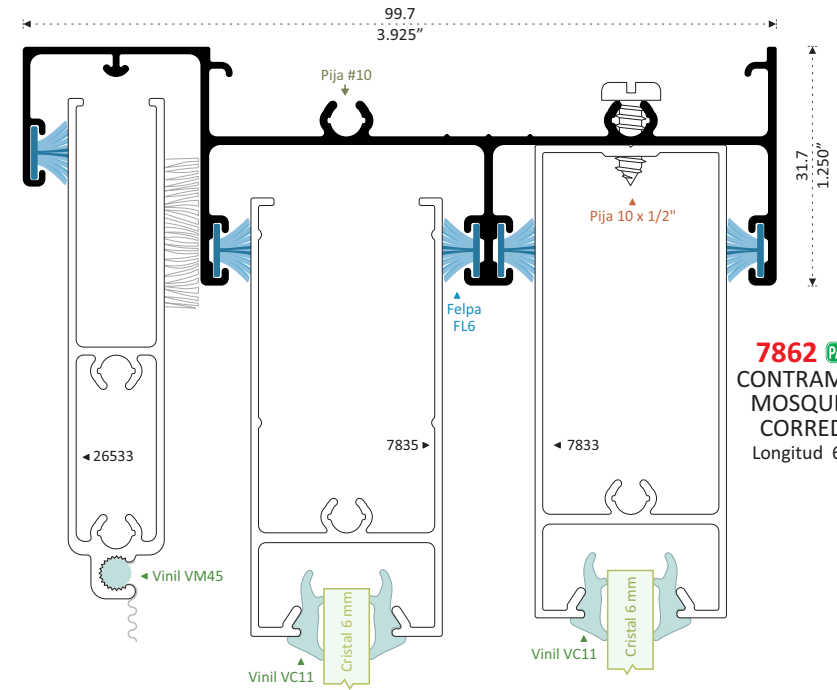

7862 PATENTE
CONTRAMARCO
MOSQUITERO
CORREDIZO
Longitud 6.10 m

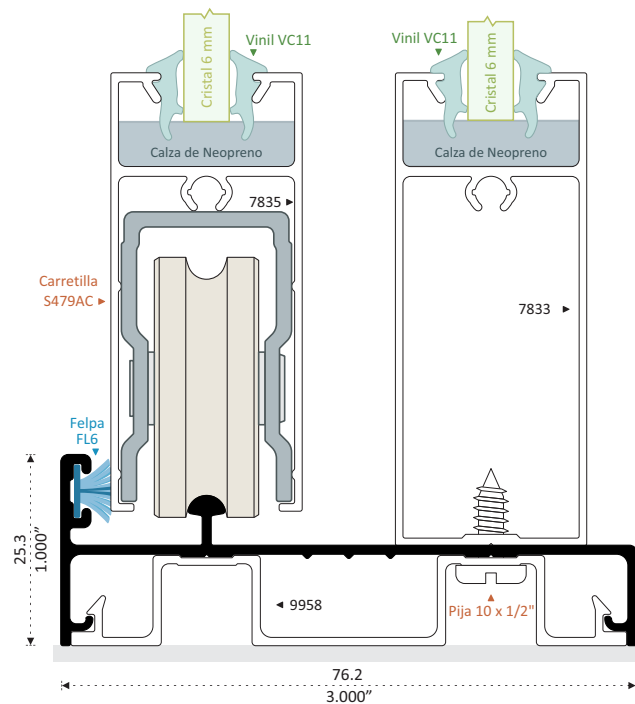

9957
RIEL
Longitud 6.10 m

Utilizar 9958 como Soporte del Riel en Cristales Grandes ó Dobles

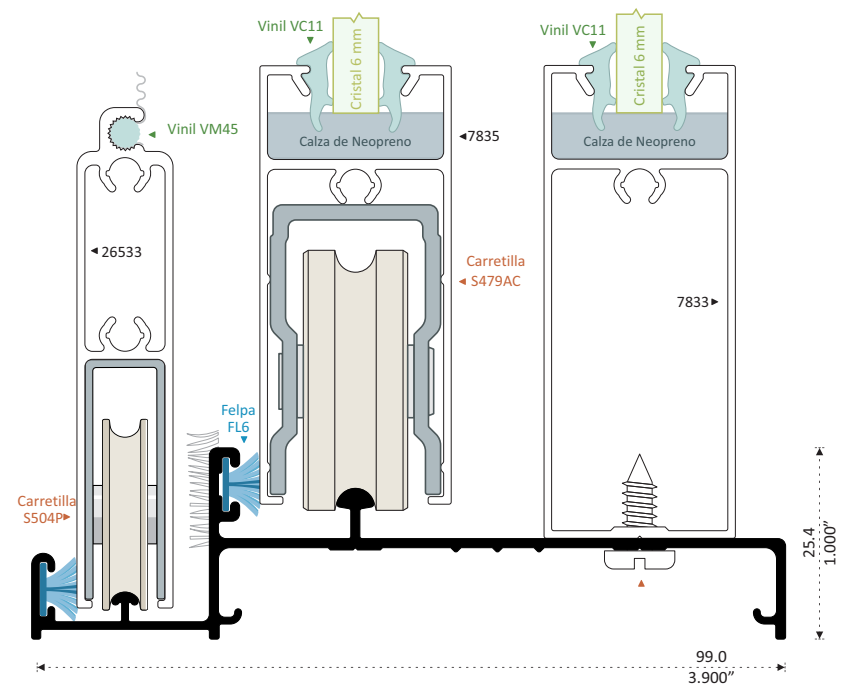

9274 PATENTE
RIEL CON MOSQUITERO INTERIOR
Longitud 6.10 m

7863
CONTRAMARCO MOSQUITERO
CORREDIZO SIN VENAS
Longitud 6.10 m

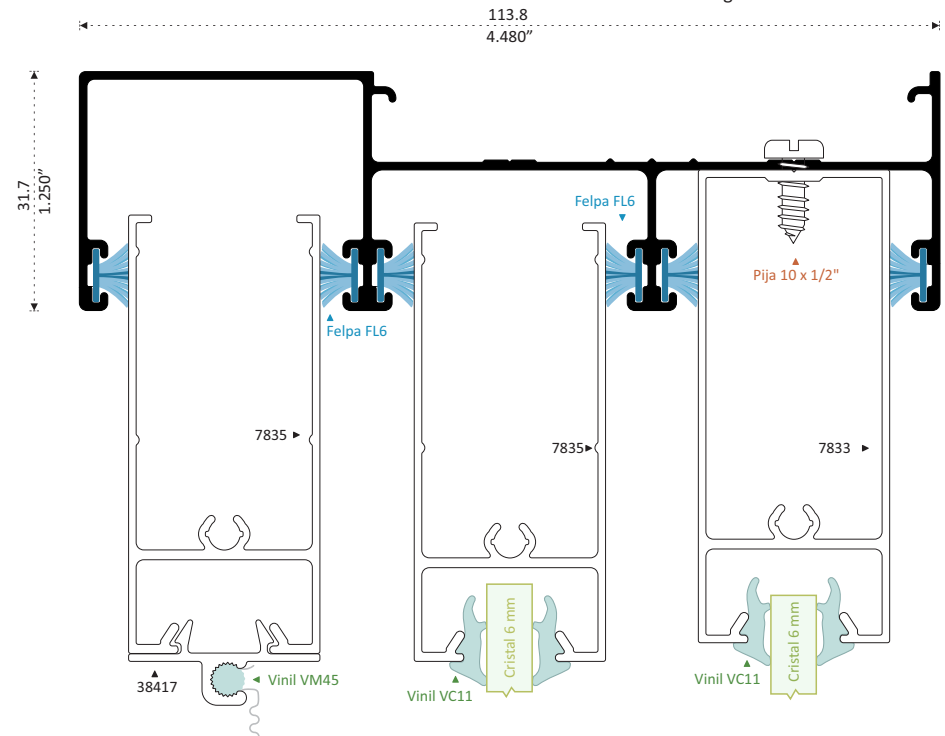

25.3
0.996"

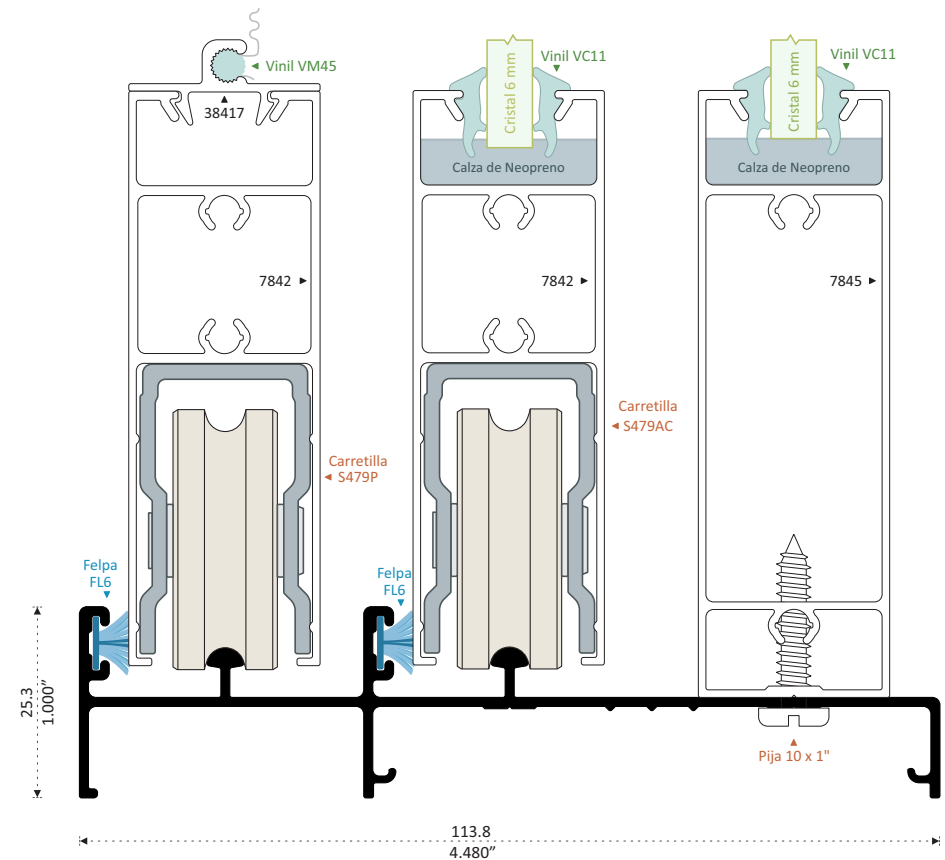

9275
RIEL CON
MOSQUITERO INTERIOR
Longitud 6.10 m

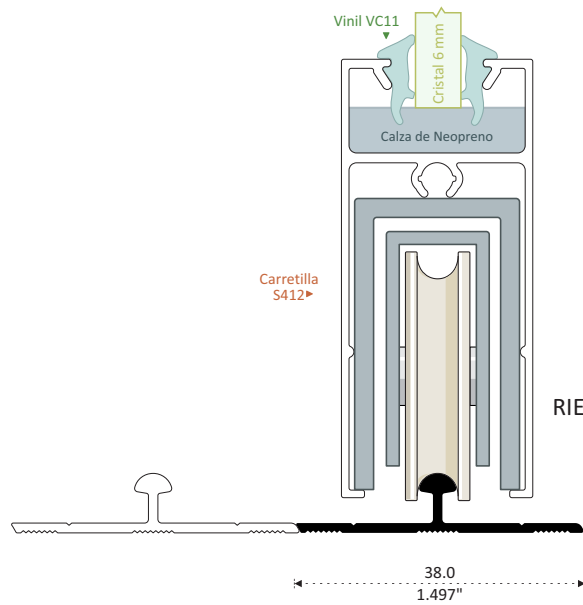

67828 PATENTE
RIEL ADAPTADOR XX
Longitud 6.10

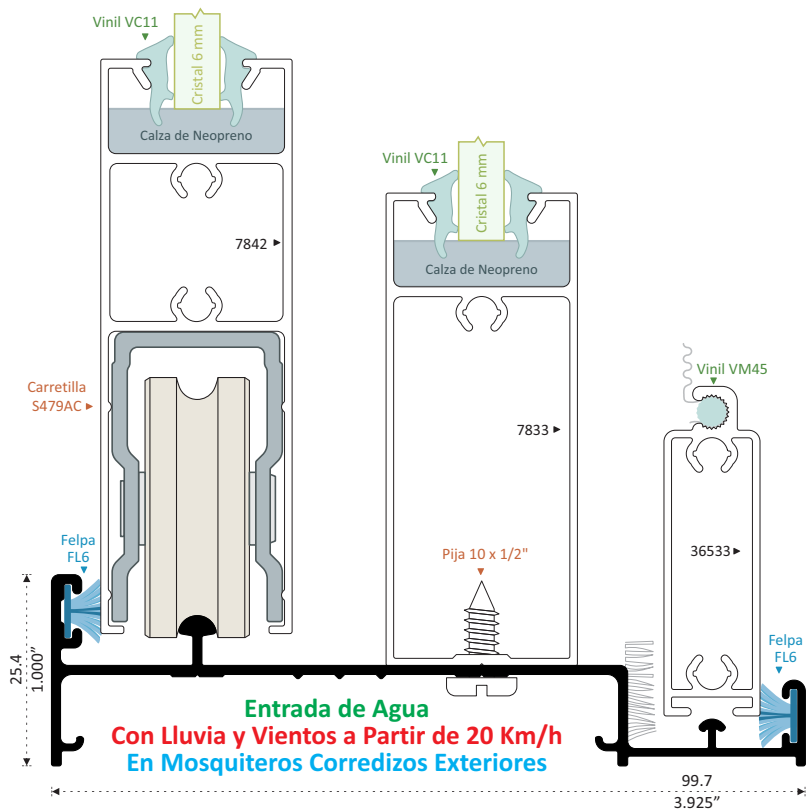

Entrada de Agua
Con Lluvia y Vientos a Partir de 20 Km/h
En Mosquiteros Corredizos Exteriores

9272 PATENTE
RIEL CON MOSQUITERO EXTERIOR
Longitud 6.10 m

Instalación en
Lugares
Semi Cubiertos

MOSQUITERO CORREDIZO 3" SIMÉTRICO CON LA LÍNEA

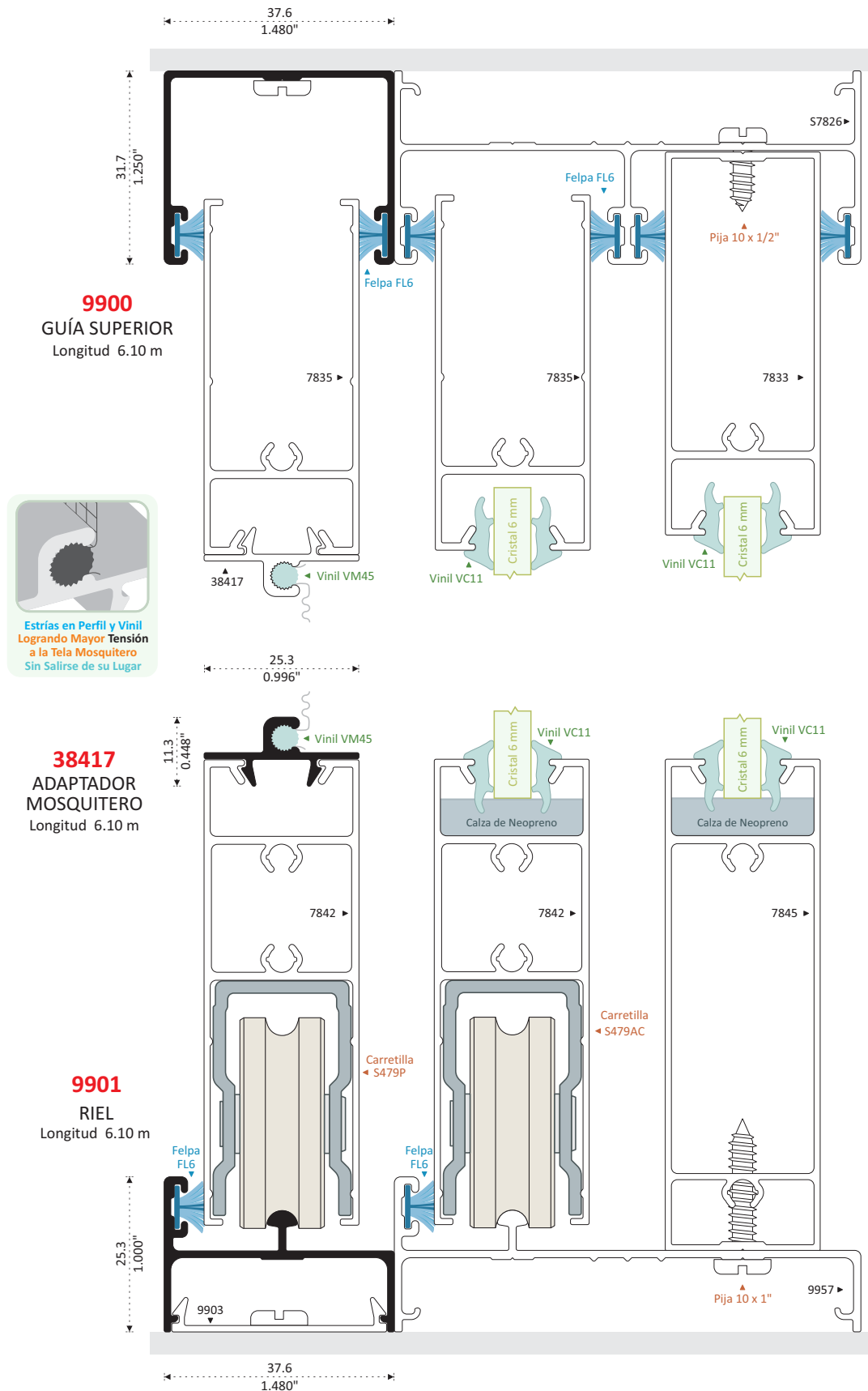

HOLGURA
PARA
DESMONTAR MOSQUITERO CON FACILIDAD



MOSQUITERO CON ALTO DESEMPEÑO
INSTALACIÓN INTERIOR

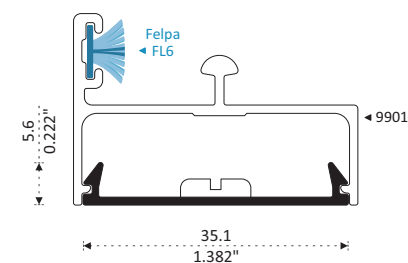

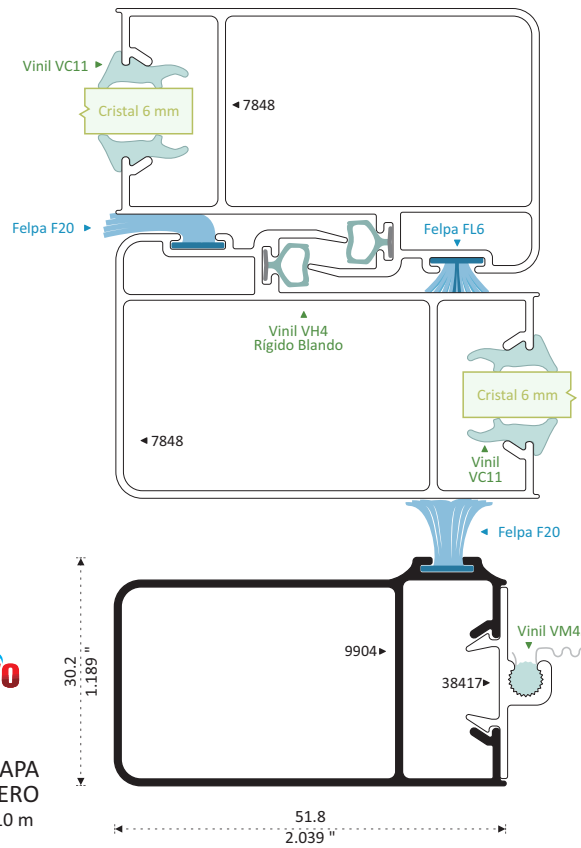
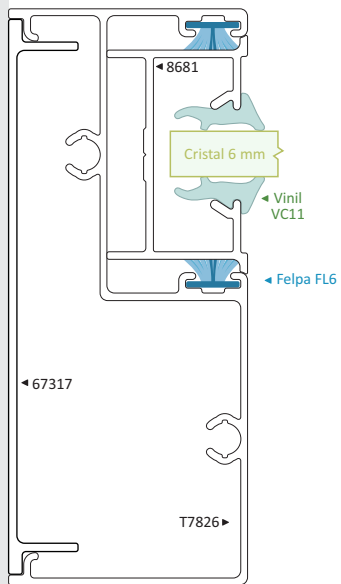

NUEVO
9904
CERCO CHAPA
MOSQUITERO
Longitud 6.10 m

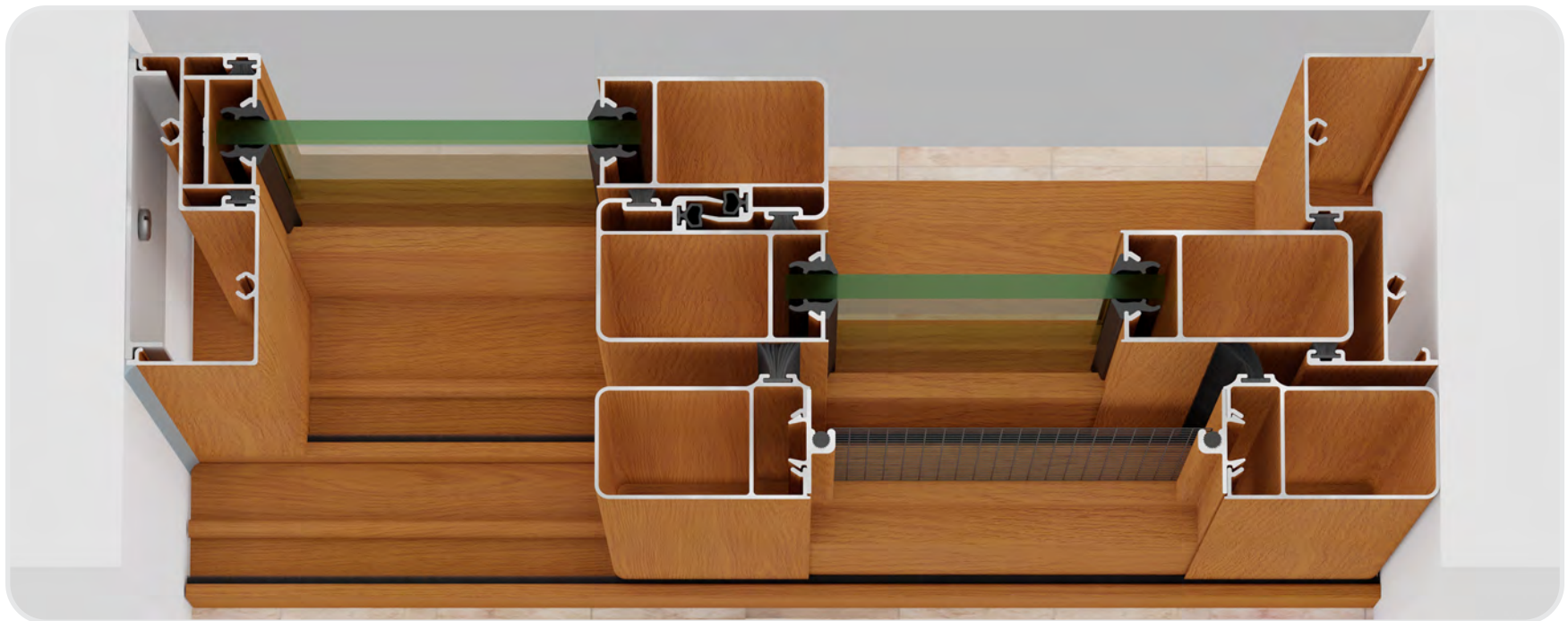
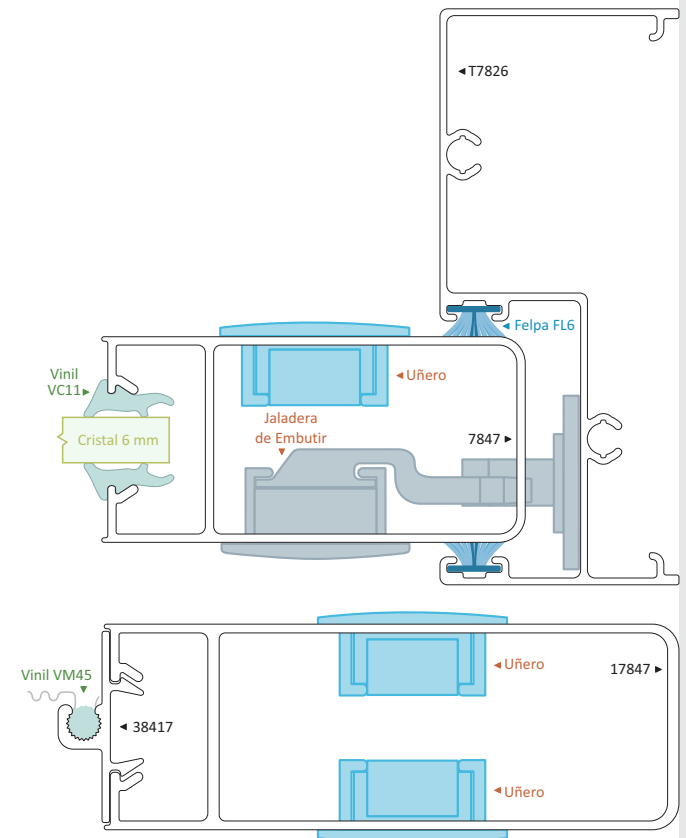

LÍNEA 3" HERMÉTICA PLUS

El Aislamiento Acústico es una Factor de Calidad, Vida y Confort

Mayor Aislamiento Acústico por sus 4 Felpas
Colocar solo de manera horizontal



4 Felpas con Labio Textil Aumentan la Hermeticidad a Viento, Polvo y Ruido

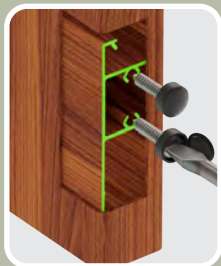

Perfil Reforzado por su Doble Vena



3 Felpas con Labio Textil Aumentan la Hermeticidad a Viento, Polvo y Ruido



Atornillado de hoja fija

MÁS RÁPIDO

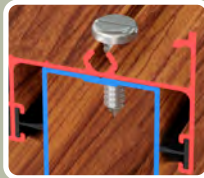

Atornille una sola vez los Traslapes, Acristale en Mesa Hojas Fija y Corrediza



Colocación Rápida de Hoja Corrediza y Hoja Fija Con Atornillado por el Exterior, en Zoclo y Cabezal

Pijas sin Contacto con el Cristal

ATORNILLAR POR FUERA

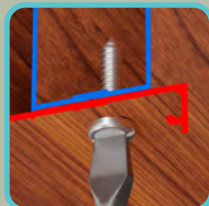

Zoclo Cerrado de Hoja Fija con Mayor Resistencia ante Ráfagas de Viento



Vista Distinguida y Más Económica

Instalado da Apariencia de un Perfil Integrado al Contramarco

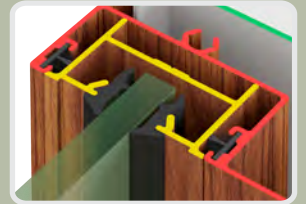

Vinil Hongo en Traslapes Aumenta Hermeticidad a: Polvo, Ruido y Viento

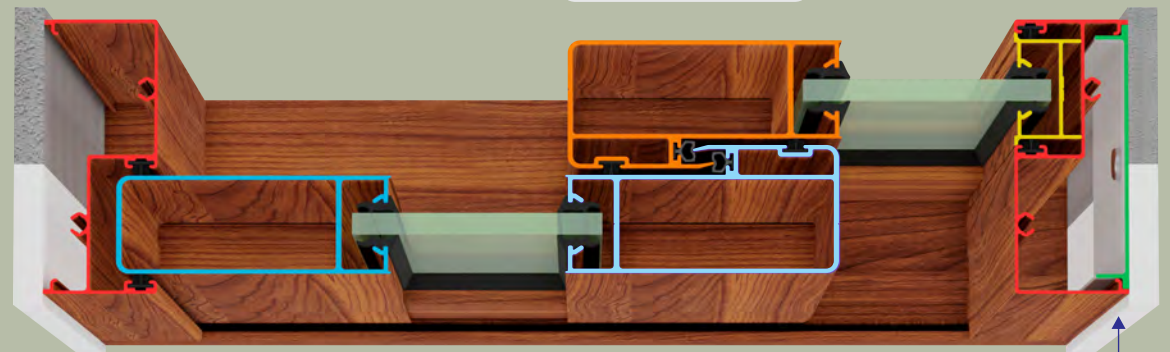

Fijación Invisible con Moldura de Fijación a Muro

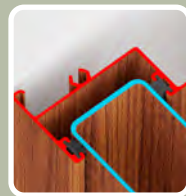

Ofrece la Experiencia de un Cierre Suave y Silencioso

Por Cerco con Esquinas Curvas y Contacto de Felpas al 100%

Opción de Cerco Chapa en Lugar de Cerco Fijo

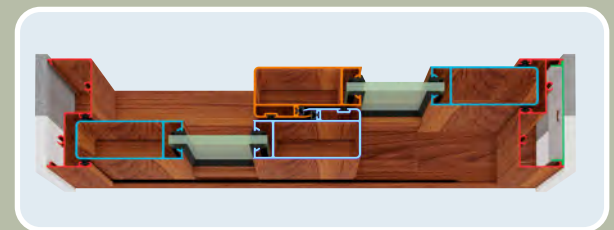

Cubiertas Traslapes

Maximiza la Hermeticidad a Viento y Polvo, entre Traslapes, Contramarco y Riel hasta un 85%



Ventana

Puerta

Aislamiento Acústico Con 17848 43.9 Decibles

Permeabilidad a Viento y Polvo Con 17848 Aire que Detiene 90 %

Resistencia A Vientos Sin Deformar el Perfil Ventana 120 Km/h Puerta 120 Km/h

AI SLAM IENTO ACÚSTICO
REALIZADO CON 120 DECIBELES AL EXTERIOR
MEDIDA 1.00 x 1.00 m

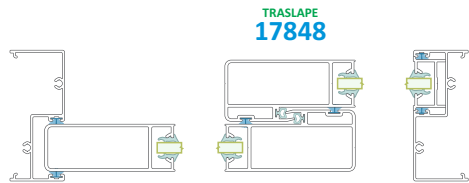

AI SLAM IENTO
43.9
Decibeles

Clave: FL6 Comercial
VH4 Vinil Hongo
VC11 Ambos lados

CON CRISTAL SENCILLO 6 mm
EXCELENTE AISLAM IENTO

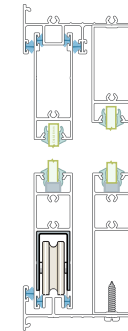

Esta Línea
Supera a otras
Corredizas en:

- **Aislamiento Acústico**
- **Permeabilidad al Viento y Polvo**

LÍNEA EXCLUSIVA PERFILETTO

PERMEABILIDAD AL AGUA DURANTE 20 MINUTOS

VELOCIDAD KM/H	Agua	Aire
20	50%	50%
40	50%	50%
60	50%	50%
80	50%	50%
100	50%	50%
120	60%	40%

SIN MOSQUITERO

Sin Filtraciones

VENTANA MEDIDA 1.00 x 1.00 m
MOSQUITERO FIJO 7336

Sin Filtraciones

MOSQUITERO CORREDIZO EXTERIOR 7842 y 9904

Sin Filtraciones

MOSQUITERO CORREDIZO EXTERIOR 7842 y 9904

VELOCIDAD KM/H	Agua	Aire	Litros Filtrados
20	50%	50%	4.57
40	50%	50%	5.68
60	50%	50%	6.72
80	50%	50%	6.78
100	50%	50%	6.86
120	60%	40%	6.93

MOSQUITERO CORREDIZO EXTERIOR OCASIONA ALTA FILTRACIÓN DE AGUA

Otros Mosquiteros Fijos Ocasionan Filtraciones Por su Altura Mayor Respecto al Riel

PUERTA MEDIDA 1.00 x 1.00 m

VELOCIDAD KM/H	Agua	Aire
20	50%	50%
40	50%	50%
60	50%	50%
80	50%	50%
100	50%	50%
120	60%	40%

SIN MOSQUITERO

Sin Filtraciones

MOSQUITERO CORREDIZO INTERIOR 7842 y 9904

Sin Filtraciones

MOSQUITERO CORREDIZO EXTERIOR 7842 y 9904

VELOCIDAD KM/H	Agua	Aire	Litros Filtrados
20	50%	50%	4.60
40	50%	50%	5.72
60	50%	50%	6.76
80	50%	50%	6.83
100	50%	50%	6.91
120	60%	40%	6.98

MOSQUITERO CORREDIZO EXTERIOR OCASIONA ALTA FILTRACIÓN DE AGUA

PERMEABILIDAD AL VIENTO Medida 1.00 x 1.00 m

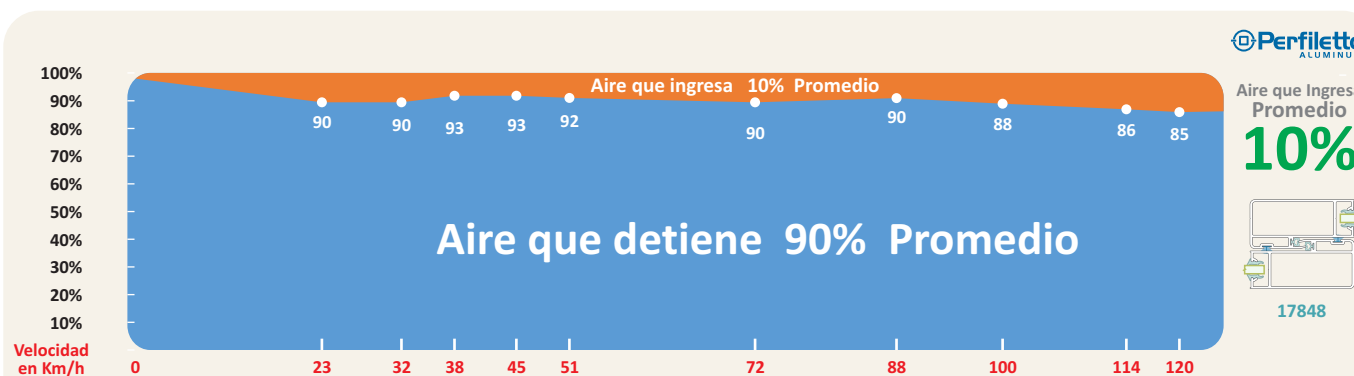

LÍNEA EXCLUSIVA PERFILETTO

RESISTENCIAS A VIENTOS

VENTANA

Prueba Realizada
30 Repeticiones de 1 Minuto c/u
A 120 Km/h
Medida 1.00 x 1.00 m
Cristal 6 mm
LOS PERFILES SIN DEFORMACIÓN
CONSERVAN SU FUNCIONAMIENTO

PUERTA

Prueba Realizada
30 Repeticiones de 1 Minuto c/u
A 120 Km/h
Medida 2.00 X 2.10 m
Cristal 6 mm
LOS PERFILES SIN DEFORMACIÓN
CONSERVAN SU FUNCIONAMIENTO

Ruptura de Cristal a 130 km/h

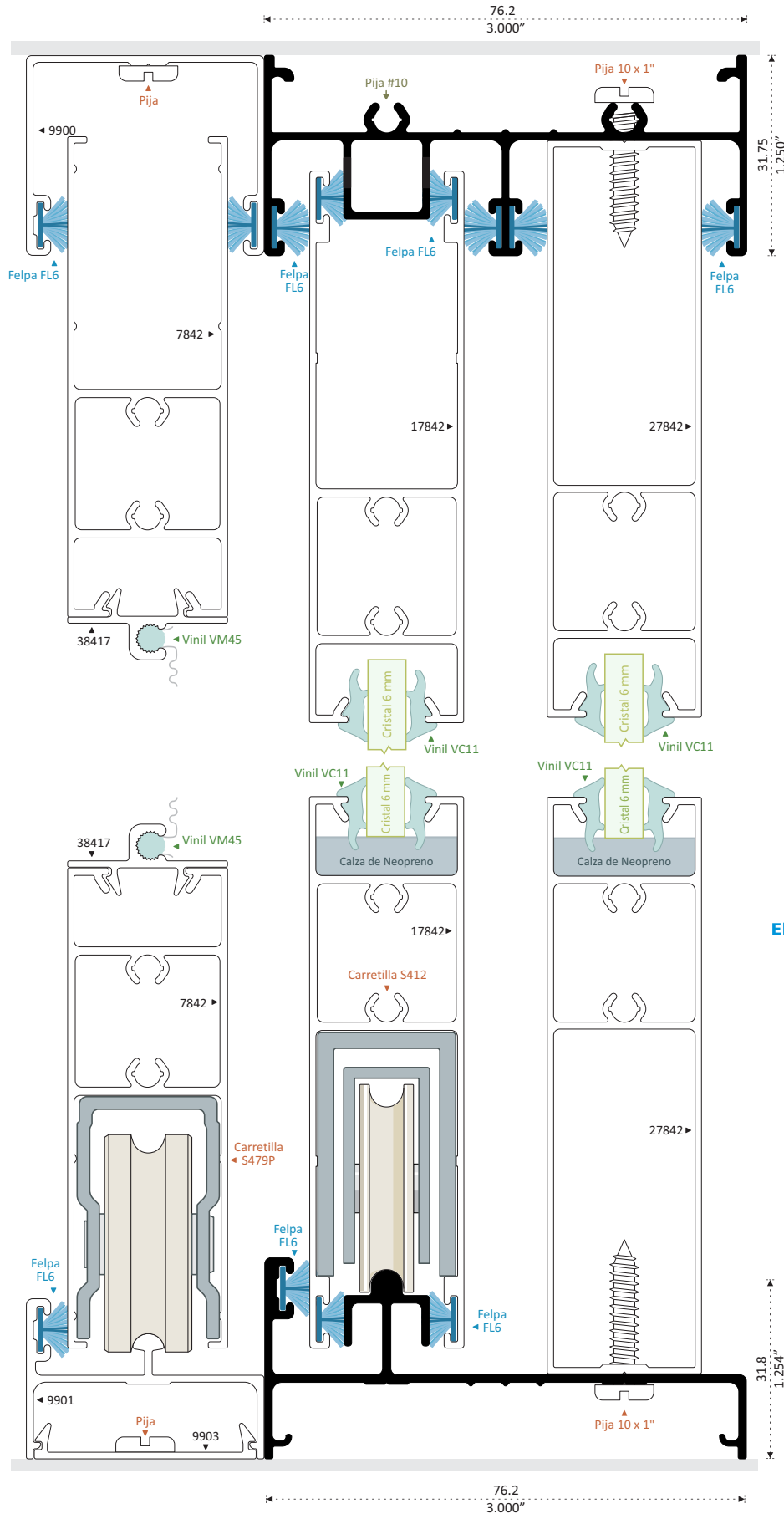

17826 PATENTE
CONTRAMARCO
Longitud 6.10 m



El Zoclo Entra hasta el Fondo del Traslape y Cerco Chapa Logrando Buena Hermeticidad

17835
ZOCLO Y CABEZAL
Longitud 6.10 m

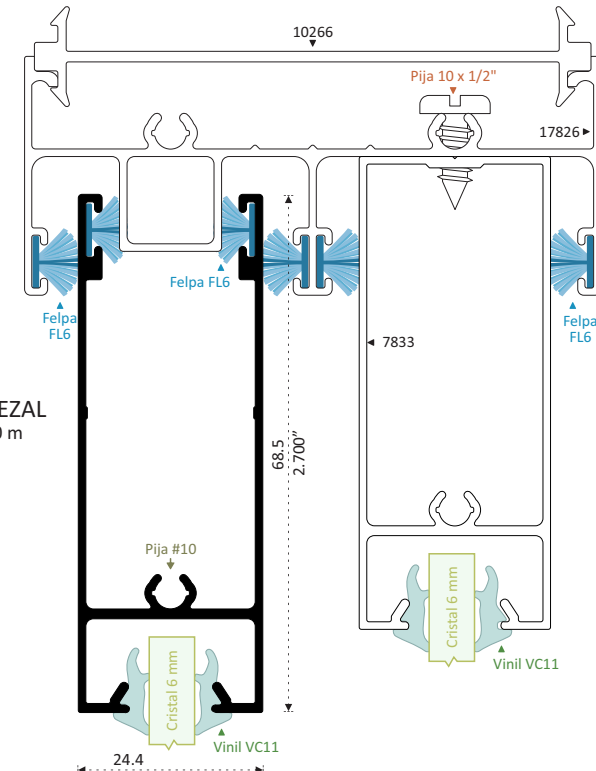

27842
ZOCLO FIJO
Longitud 6.10 m

17842
ZOCLO PUERTA HERMÉTICO
Longitud 6.10 m

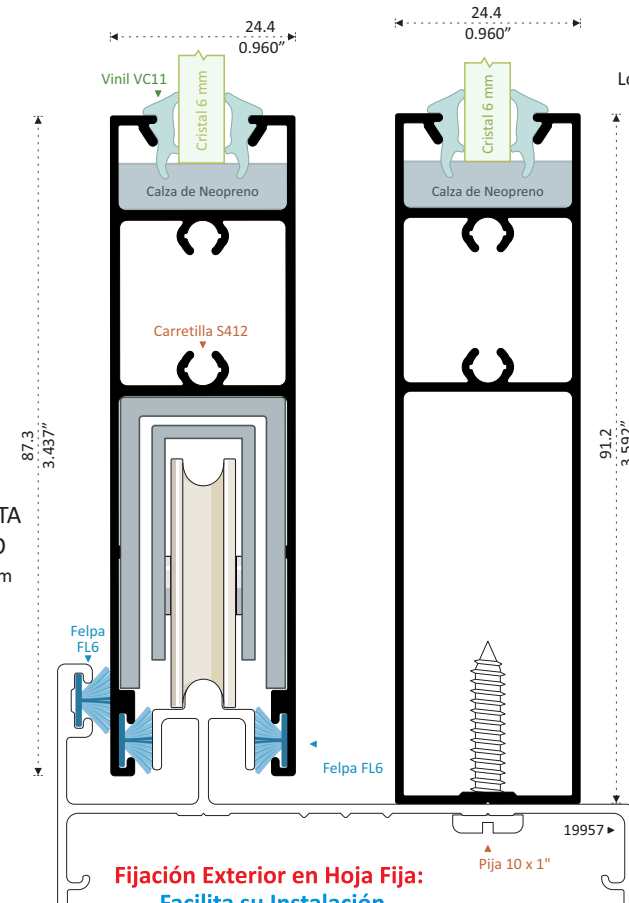

Fijación Exterior en Hoja Fija:
- Facilita su Instalación.
- Mayor Resistencia a Vientos.

NUEVO
19957 PATENTE
RIEL HERMÉTICO
Longitud 6.10 m

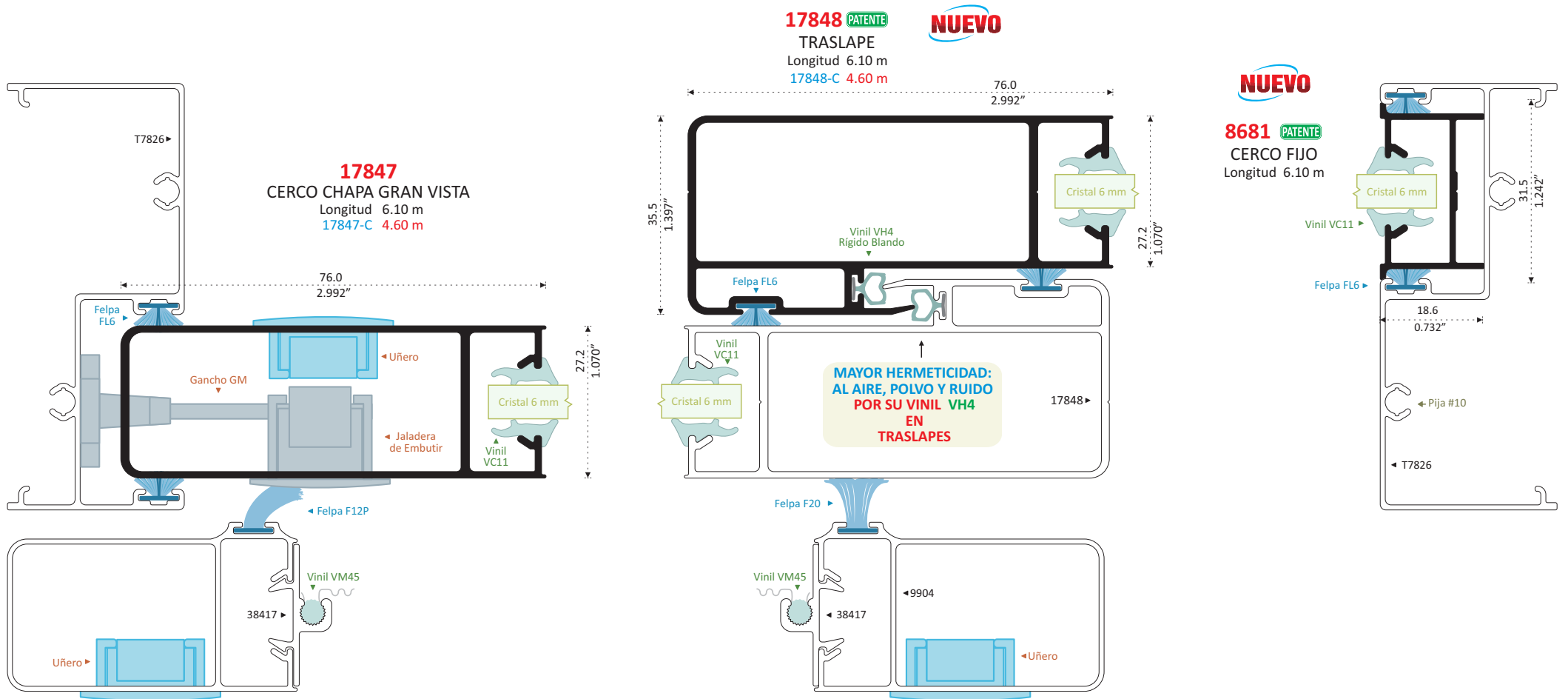

Excelente Aislamiento Acústico, Viento y Polvo



**Disminuye la Entrada
de Viento y Polvo Por Hermetizar en 6 Felpas
en la Parte Superior**



**Disminuye la Entrada
de Viento y Polvo Por Hermetizar en 3 Felpas
en la Parte Inferior**

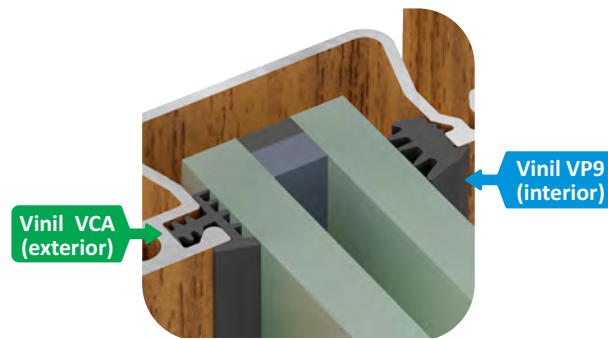
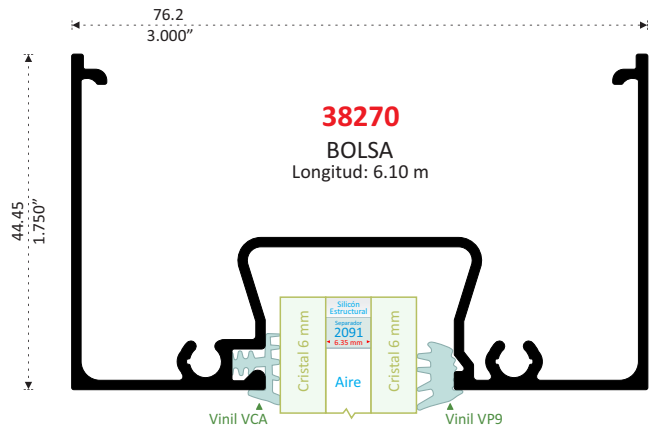

**Aumenta la Hermeticidad Acústica,
Colocando Vinil por Ambos Lados**

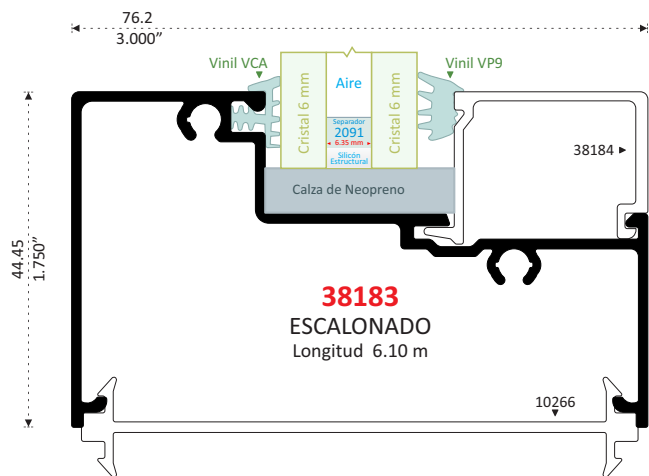
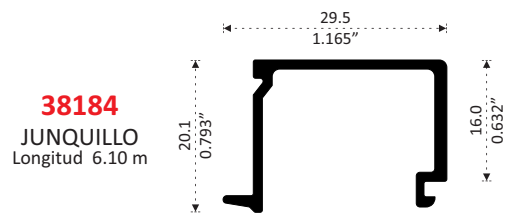
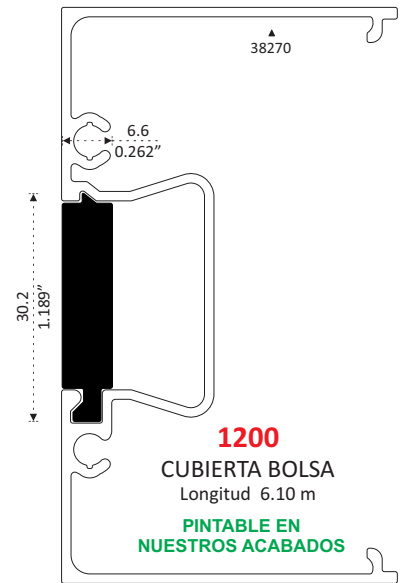

LÍNEA FIJA

Vinil VCA Vinil VP9

AISLAMIENTO
45.2
Decibeles

SEPARADOR
2091
6mm + Separador 6.35 mm + 6mm

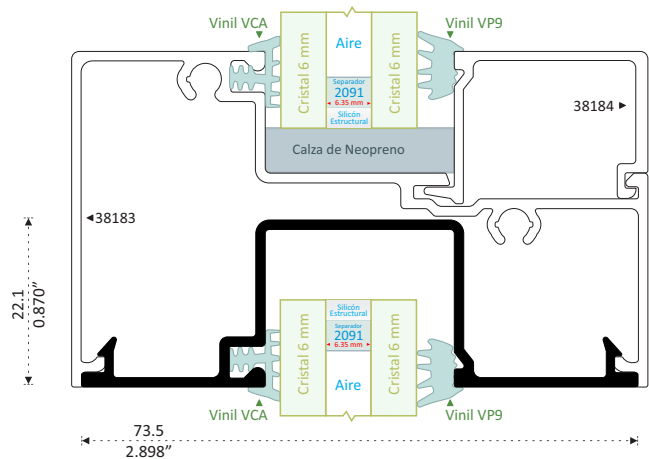

Utilizar como Soporte del Escalonado
en Cristales Pesados



Aumenta la Hermeticidad Acústica, Colocando Vinil por Ambos Lados

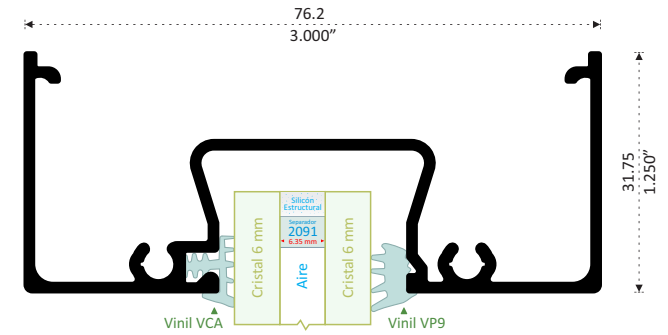
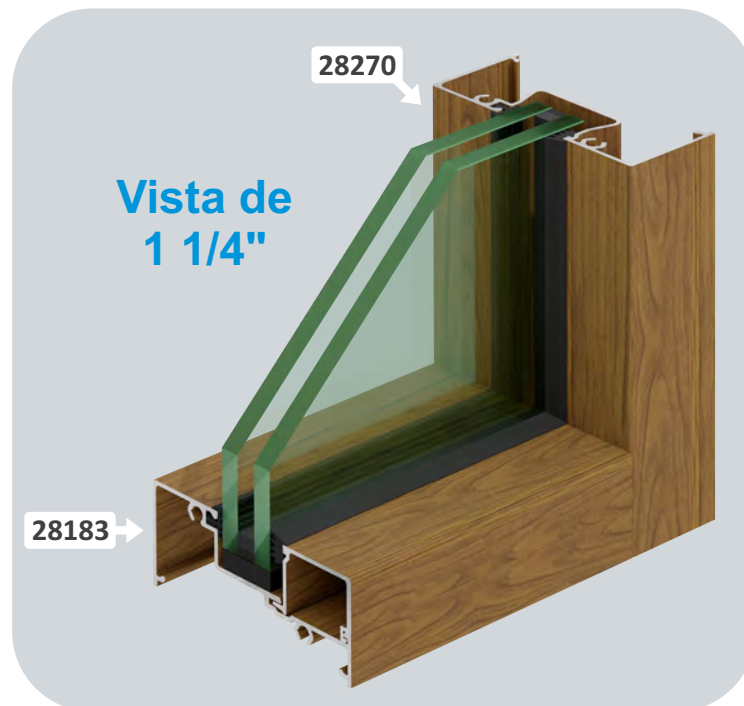
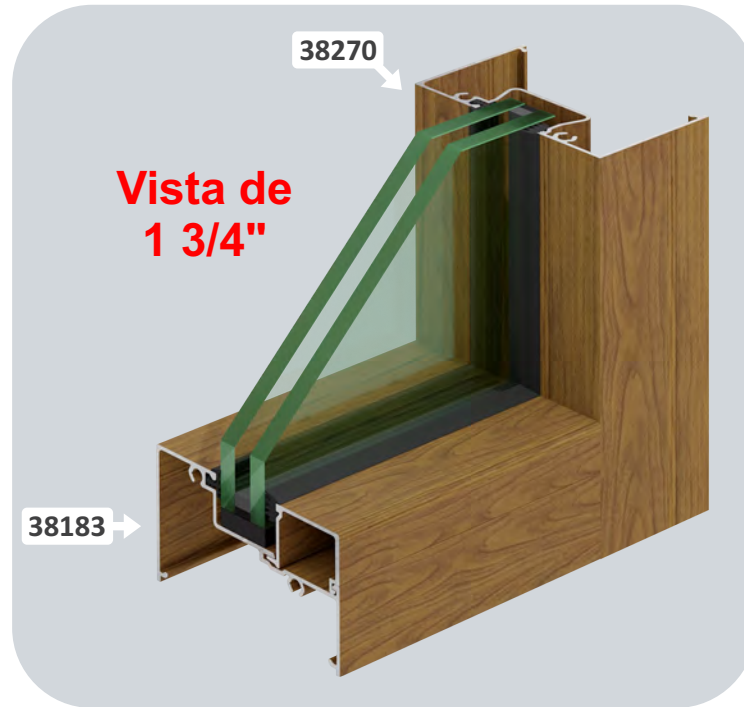

28270
BOLSA
Longitud: 6.10 m

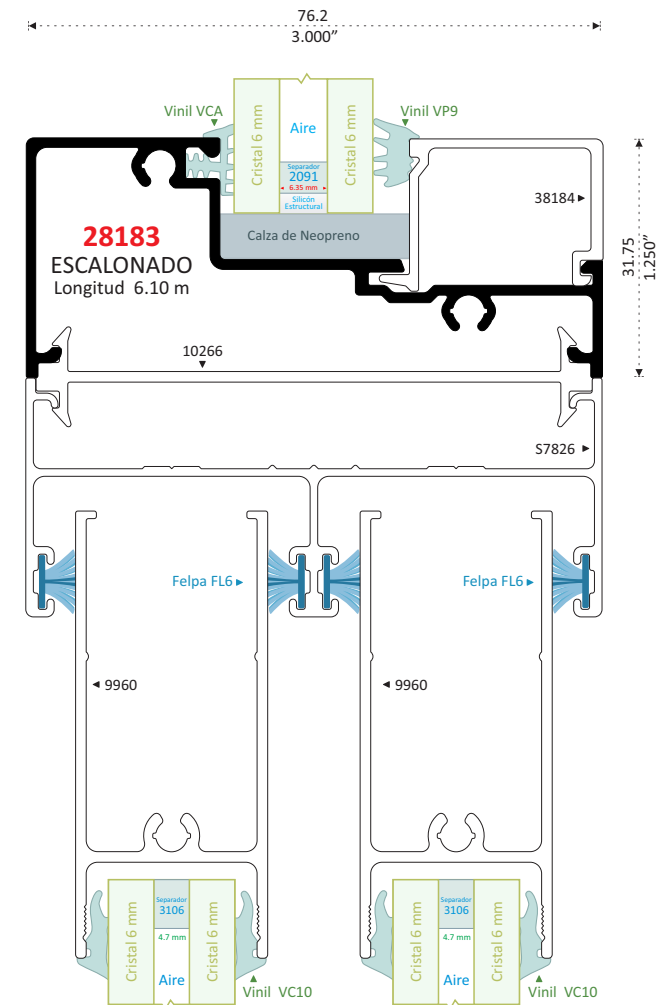

LÍNEA 3" CRISTAL DOBLE HERMÉTICA

Convierte un Producto Perfiletto En Extraordinario

Buscas Mayor Aislamiento Térmico
El Cristal Doble es la Mejor Opción

Armado Horizontal Superior

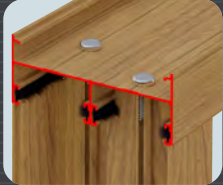

Más Acercamiento de Felpas logrando
MAYOR HERMETICIDAD



Estrías para una Mayor Adherencia del Doble Vinil

MAYOR ACERCAMIENTO de Felpa con Zoclo



En Cristales Pesados
Colocar Soporte Riel 9958
Con 4 Puntos de Apoyo

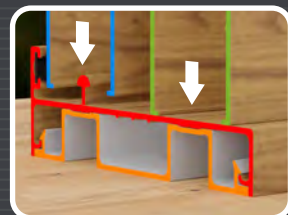

Atornille una sola vez los Traslapes, Acristale en Mesa Hojas Fija y Corrediza



Colocación Rápida de Hoja Corrediza y Hoja Fija Con Atornillado por el Exterior, en Zoclo y Cabezal

Pijas sin Contacto con el Cristal



Vista Distinguida y Más Económica

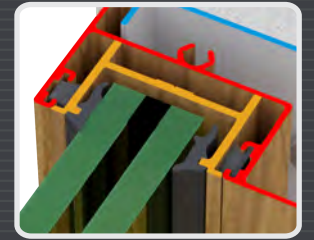

Instalado da Apariencia de un Perfil Integrado al Contramarco

Vinil Hongo en Traslapes Aumenta Hermeticidad a: Polvo, Ruido y Viento



Fijación Invisible con Moldura de Fijación a Muro

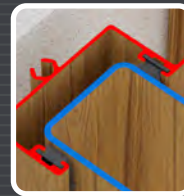

Ofrece la Experiencia de un Cierre Suave y Silencioso

Por Cerco con Esquinas Curvas y Contacto de Felpas al 100%

Doble Cristal Reduce el Consumo de Energía en Calefactores y Aires Acondicionados

CTA3



Cubiertas Traslapes

Maximiza la Hermeticidad a Viento y Polvo, entre Traslapes, Contramarco y Riel hasta un

85%

Doble Acristalamiento Reduce la Presencia de Temperaturas Bajas en Invierno y Altas en Verano

■ Aislamiento Acústico Con 9963 41.0 Decibles

■ Permeabilidad a Viento y Polvo Ventana con 9963 Aire que Detiene 93 %

■ Resistencia A Vientos Sin Deformar el Perfil Ventana 120 Km/h Puerta 120 Km/h

AISLAMIENTO ACÚSTICO
REALIZADO CON 120 DECIBELES AL EXTERIOR
MEDIDA 1.00 x 1.00 m

SEPARADOR
3106
6mm + Separador 4.7 mm + 6mm

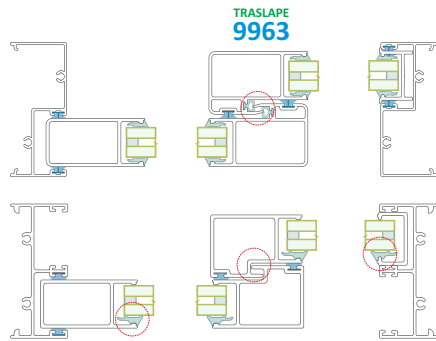

AISLAMIENTO

41.0 Decibeles

Clave: FL6 Comercial
VH4 Vinil Hongo
VC10 Ambos lados

25%
Más Eficiente



AISLAMIENTO

31.6 Decibeles

Clave: FG Comercial
Vinil Cuña Interior

OTROS
COMPETIDORES

PERMEABILIDAD AL AGUA DURANTE 20 MINUTOS

VENTANA MEDIDA 1.00 x 1.00 m

VELOCIDAD KM/H	Agua	Aire
20	50%	50%
40	50%	50%
60	50%	50%
80	50%	50%
100	50%	50%
120	60%	40%

VELOCIDAD KM/H	Agua	Aire	Litros Filtrados
20	50%	50%	4.61
40	50%	50%	5.29
60	50%	50%	6.08
80	50%	50%	6.35
100	50%	50%	6.45
120	60%	40%	6.75

MOSQUITERO CORREDIZO EXTERIOR 16533 y 16534

MOSQUITERO FIJO 7336

MOSQUITERO CORREDIZO INTERIOR 6533 y 6534

Sin Filtraciones

Sin Filtraciones

Sin Filtraciones

MOSQUITERO CORREDIZO EXTERIOR OCASIONA ALTA FILTRACIÓN DE AGUA

Otros Mosquiteros Fijos Ocasianan Filtraciones Por su Altura Mayor Respecto al Riel

PUERTA MEDIDA 1.00 x 1.00 m

VELOCIDAD KM/H	Agua	Aire
20	50%	50%
40	50%	50%
60	50%	50%
80	50%	50%
100	50%	50%
120	60%	40%

VELOCIDAD KM/H	Agua	Aire	Litros Filtrados
20	50%	50%	4.65
40	50%	50%	5.32
60	50%	50%	6.18
80	50%	50%	6.40
100	50%	50%	6.65
120	60%	40%	6.80

MOSQUITERO CORREDIZO EXTERIOR 16533 y 16534

SIN MOSQUITERO

MOSQUITERO CORREDIZO INTERIOR 6533 y 6534

Sin Filtraciones

Sin Filtraciones

MOSQUITERO CORREDIZO EXTERIOR OCASIONA ALTA FILTRACIÓN DE AGUA

PERMEABILIDAD AL VIENTO Medida 1.00 x 1.00 m

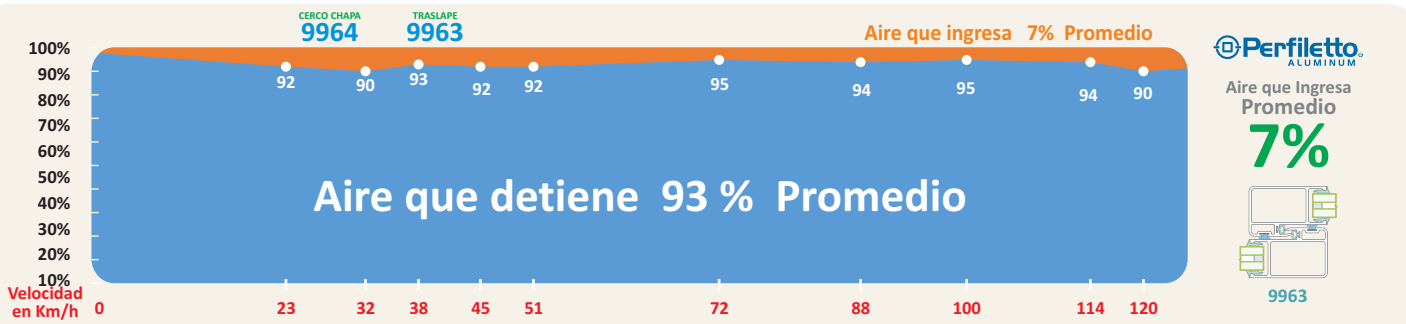

RESISTENCIAS A VIENTOS

VENTANA

Prueba Realizada
30 Repeticiones de 1 Minuto c/u
A 120 Km/h

Medida 1.00 x 1.00 m
Dos Cristales 6 mm

LOS PERFILES SIN DEFORMACIÓN
CONSERVAN SU
FUNCIONAMIENTO

OTROS COMPETIDORES

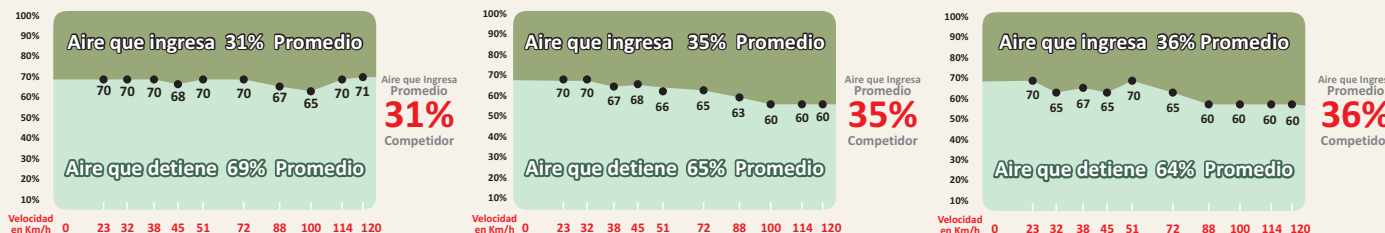

PUERTA

Prueba Realizada
30 Repeticiones de 1 Minuto c/u
A 120 Km/h

Medida 2.00 X 2.10 m
Dos Cristales 6 mm

LOS PERFILES SIN DEFORMACIÓN
CONSERVAN SU
FUNCIONAMIENTO

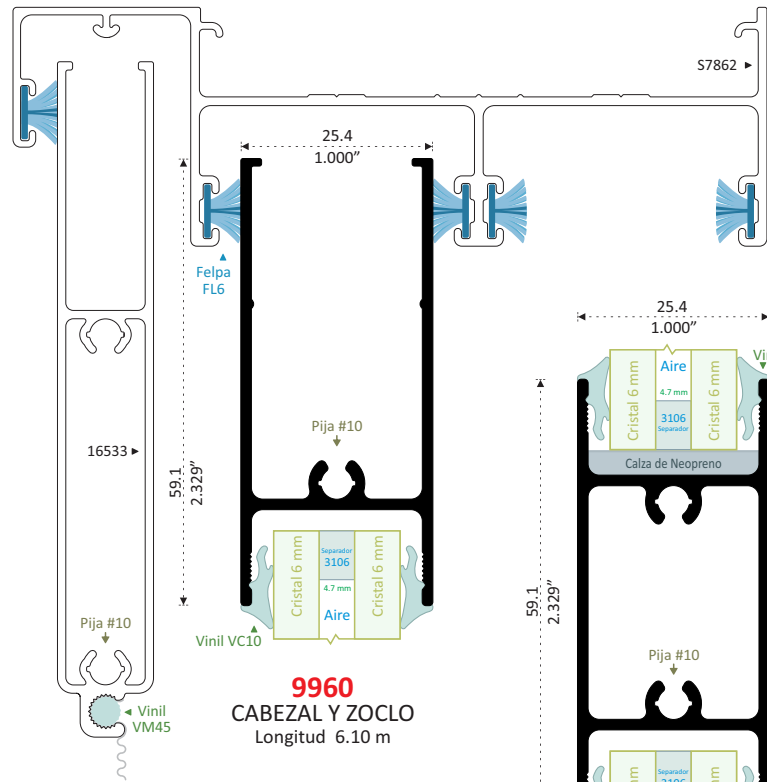

9960
CABEZAL Y ZOCLO
Longitud 6.10 m

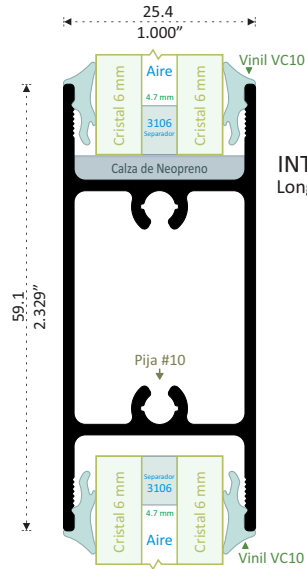

9961
INTERMEDIO
Longitud 6.10 m

9959
ZOCLO
Longitud 6.10 m

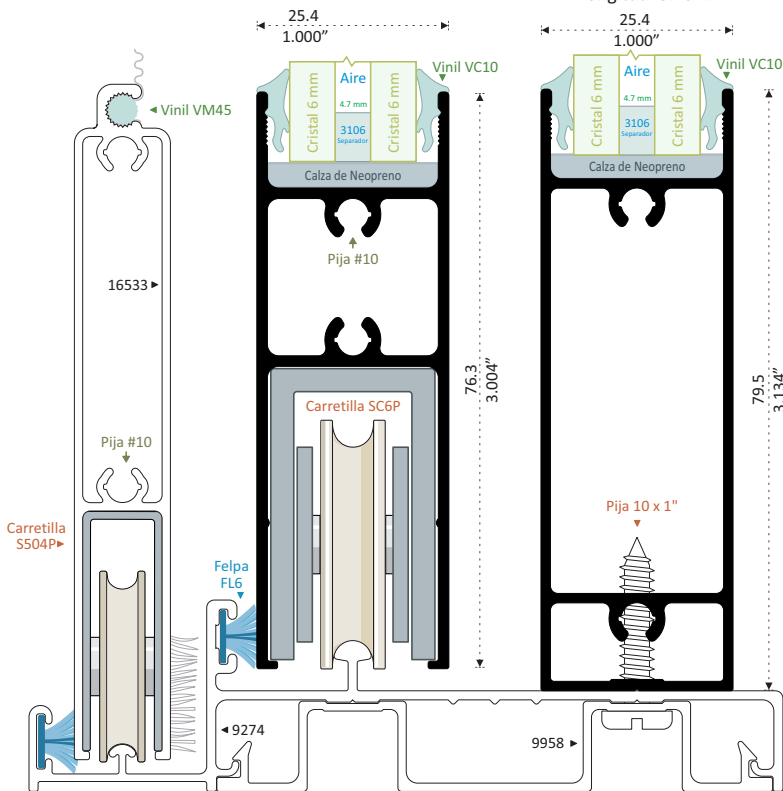

9962 NUEVO
ZOCLO FIJO
Longitud 6.10 m

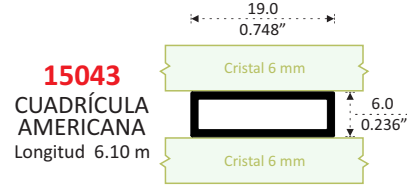
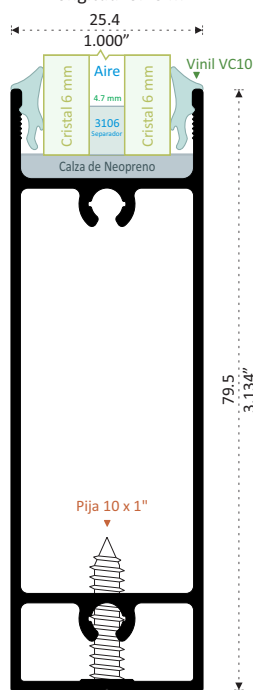

15043
CUADRÍCULA AMERICANA
Longitud 6.10 m

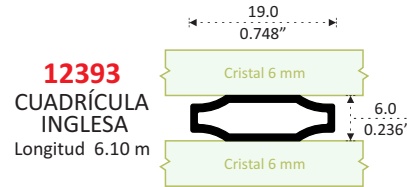

12393
CUADRÍCULA INGLESA
Longitud 6.10 m

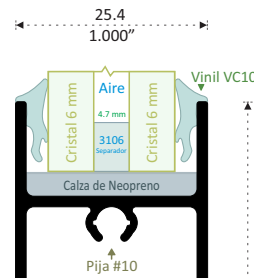
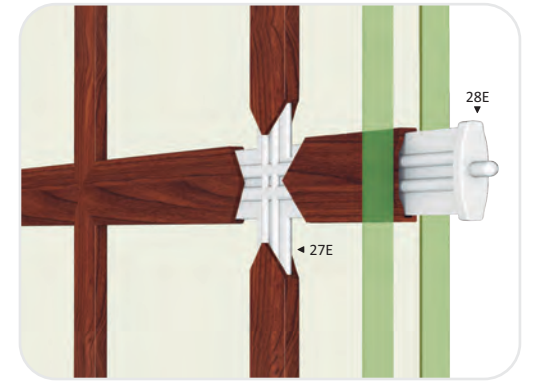

19959
ZOCLO PUERTA 5"
Longitud 6.10 m

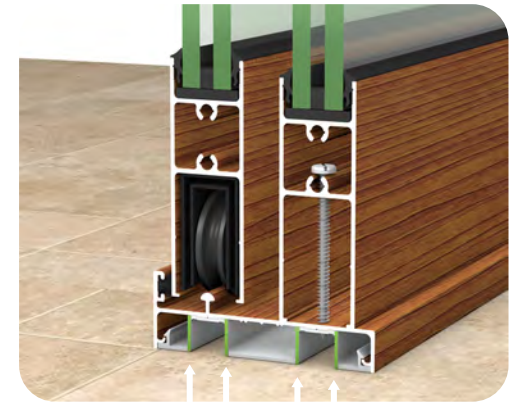
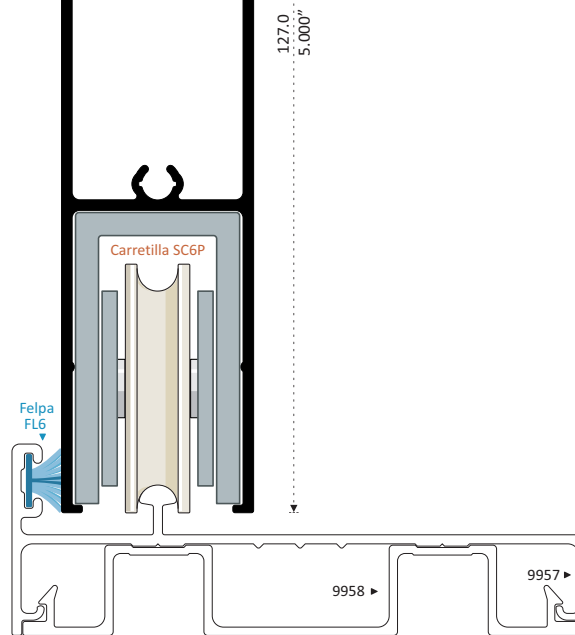

4 Puntos de Soporte para Cristales Pesados

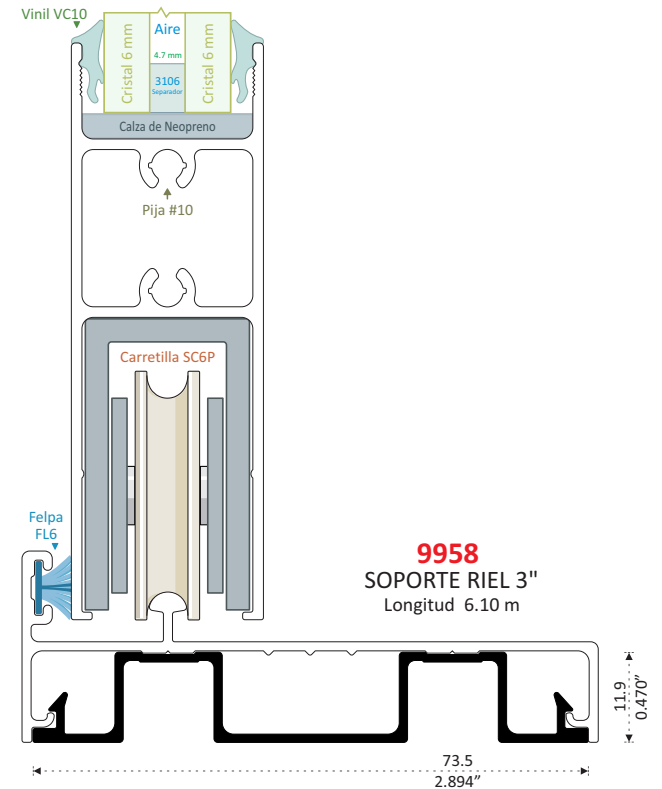

9958
SOPORTE RIEL 3"
Longitud 6.10 m

Utilizar 9958 como Soporte del Riel en Cristales Grandes ó Dobles

Aumenta la Hermeticidad Acústica, Colocando Vinil por Ambos Lados

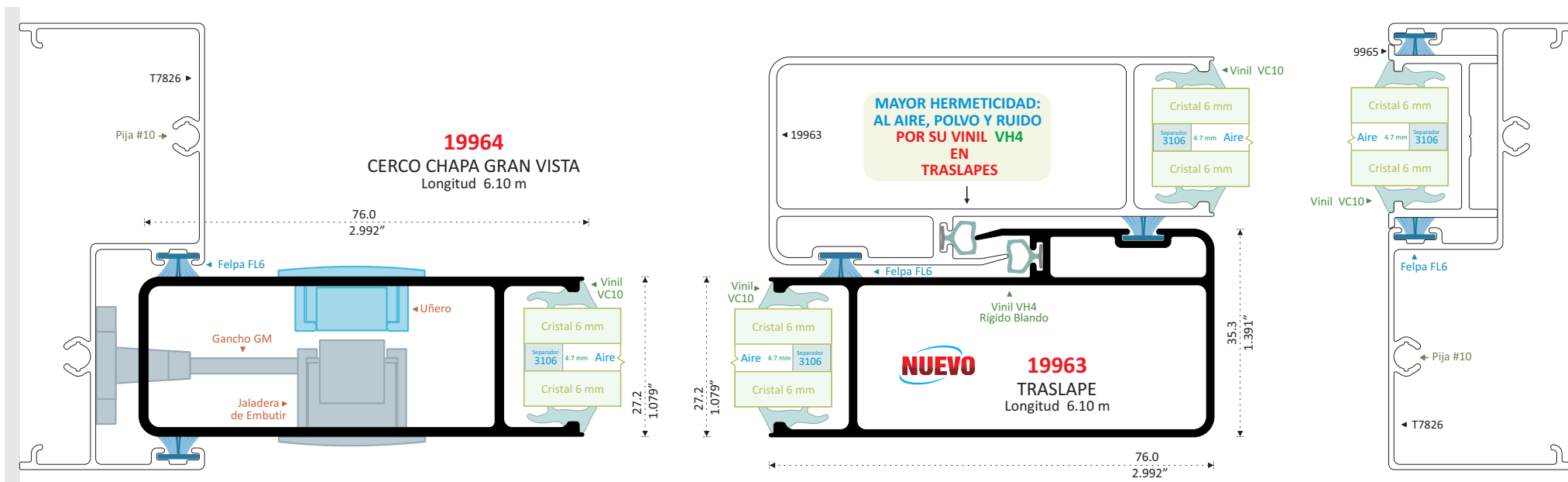
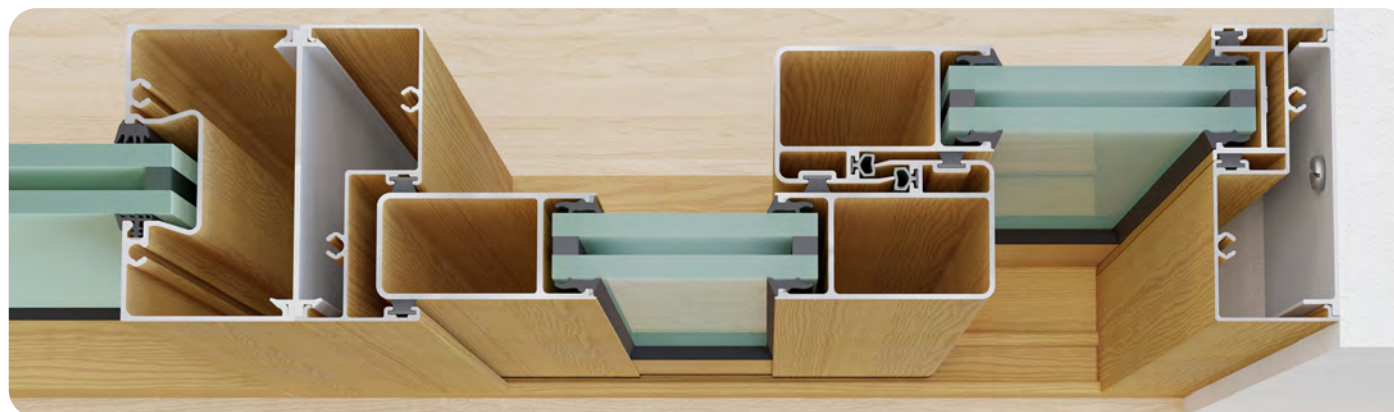
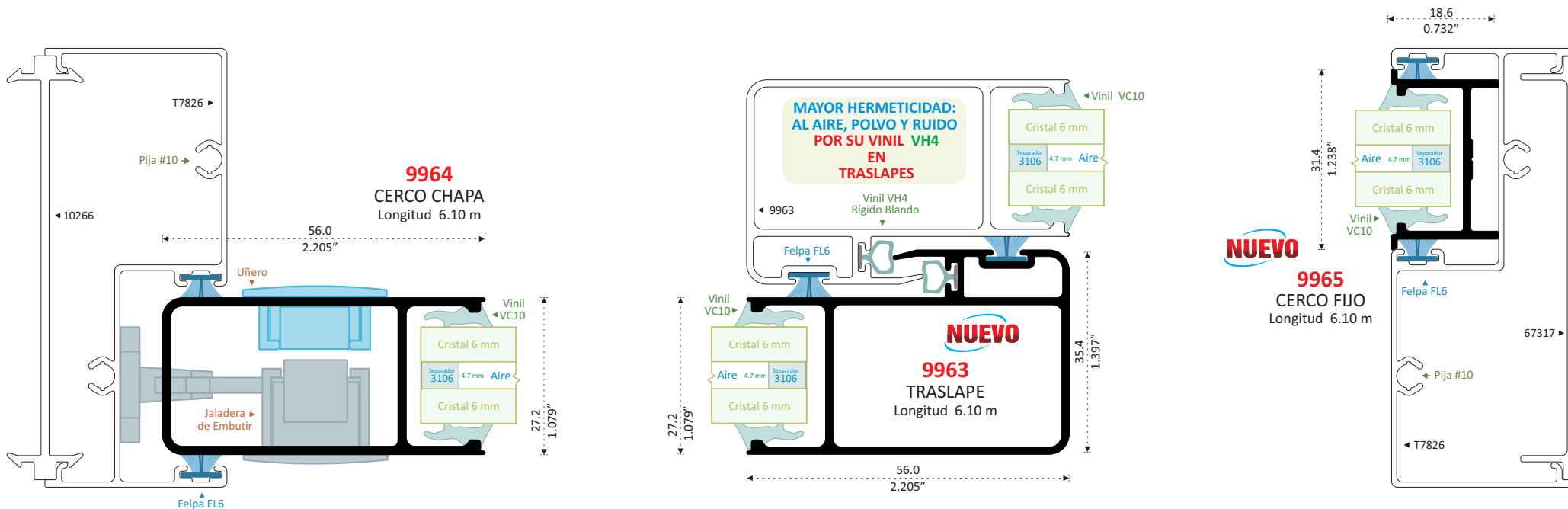

LÍNEA 3" **BATIENTE O PROYECCIÓN**

Proyección

Guías Para Instalación de:

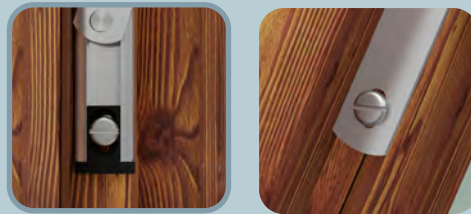

- Brazos de Proyección



- Brazos Fricción



- Bisagras

Vista Frontal
Sencilla y Elegante
sin
Vinil en el Marco

Abatible



Armado Rápido
de Marco
con
Escuadra de Botón
EM50



Armado Rápido
de Contramarco
con
Escuadra de Botón
EC50

Ventajas
Vinilos Base Rigida

- Colocación Rápida
- No se Contrae después de su Colocación
- Alta Resistencia a la Intemperie

Vinil Aleta Vinil Hongo



Aumentan la Hermeticidad:

- Acústica
- Viento
- Polvo
- Agua

Manija
Batiente - Proyección



M3

DESCUBRE OTRAS OPCIONES PARA TU CANCELERÍA

Batiente
Multi-Líneas



Cierre con Imanes

ELIGE EL ESTILO DE MOSQUITERO

Fijo



Apertura y Cierre
Con Operador de Brazo

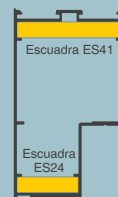

En Hojas Mayores a 20 kg
Armar con Escuadras de Aluminio
y Pijas 2618

15 Diferentes
Opciones
de
Junquillos

Aislamiento Acústico 46.6 Decibles

Permeabilidad
a Viento y Polvo

Aire que Detiene 96 %

Resistencia A Vientos
Sin Deformar el Perfil 120 Km/h

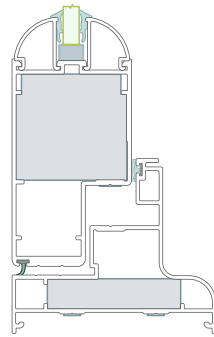

AISLAMIENTO ACÚSTICO
 REALIZADO CON 120 DECIBELES AL EXTERIOR
 MEDIDA 1.00 x 1.00 m

 Vinil VAP	 Vinil VHP	 VC12 Ambos lados	AISLAMIENTO 42.6 Decibeles
------------------------------------------------------------------------------------------------	--------------------------------------------------------------------------------------------------	---------------------------------------------------------------------------------------------------------	-----------------------------------------



LÍNEA EXCLUSIVA PERFILETTO

PERMEABILIDAD AL AGUA DURANTE 20 MINUTOS

VENTANA MEDIDA 1.00 x 1.00 m

VELOCIDAD KM/H	Agua	Aire	SIN MOSQUITERO	MOSQUITERO FIJO
20	50%	50%	Sin Filtraciones	25173 Sin Filtraciones
40	50%	50%		
60	50%	50%		
80	50%	50%		
100	50%	50%		
120	60%	40%		

PERMEABILIDAD AL VIENTO Medida 1.00 x 1.00 m



RESISTENCIAS A VIENTOS

VENTANA

Prueba Realizada
30 Repeticiones de 1 Minuto c/u
 A 120 Km/h

Medida 1.00 x 1.00 m
 Cristal 6 mm

LOS PERFILES SIN DEFORMACIÓN
CONSERVAN SU
FUNCIONAMIENTO



Armado El Marco de la Hoja con Escuadra de Botón Hasta 20 Kg.





Más de 20 Kg. Armado con Escuadra de Aluminio

Marco de Hoja 54395 con Escuadra EM50

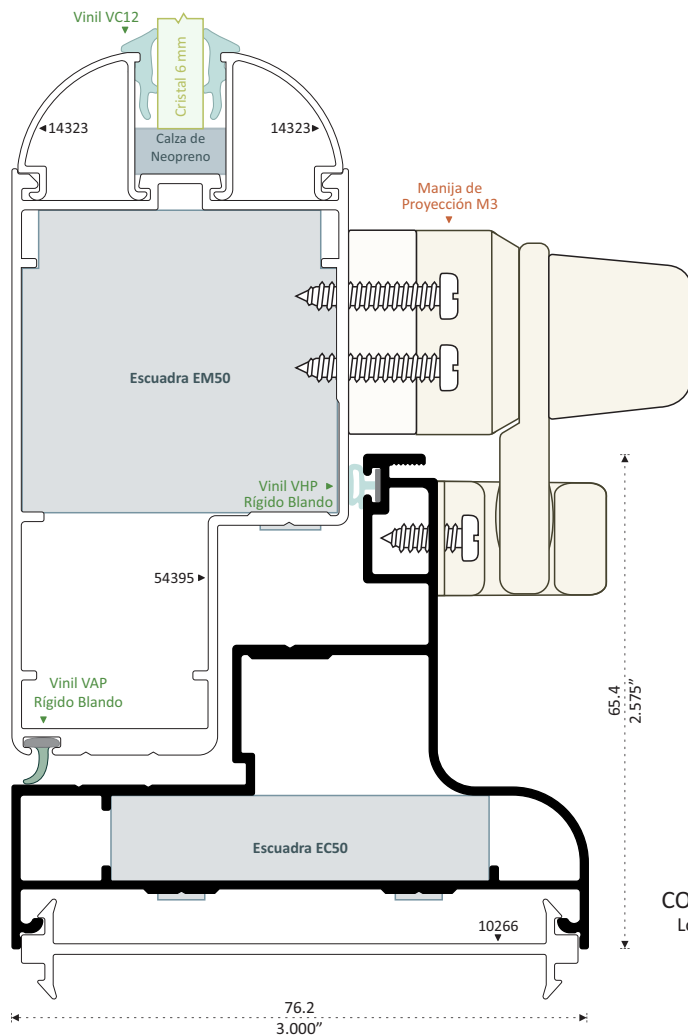
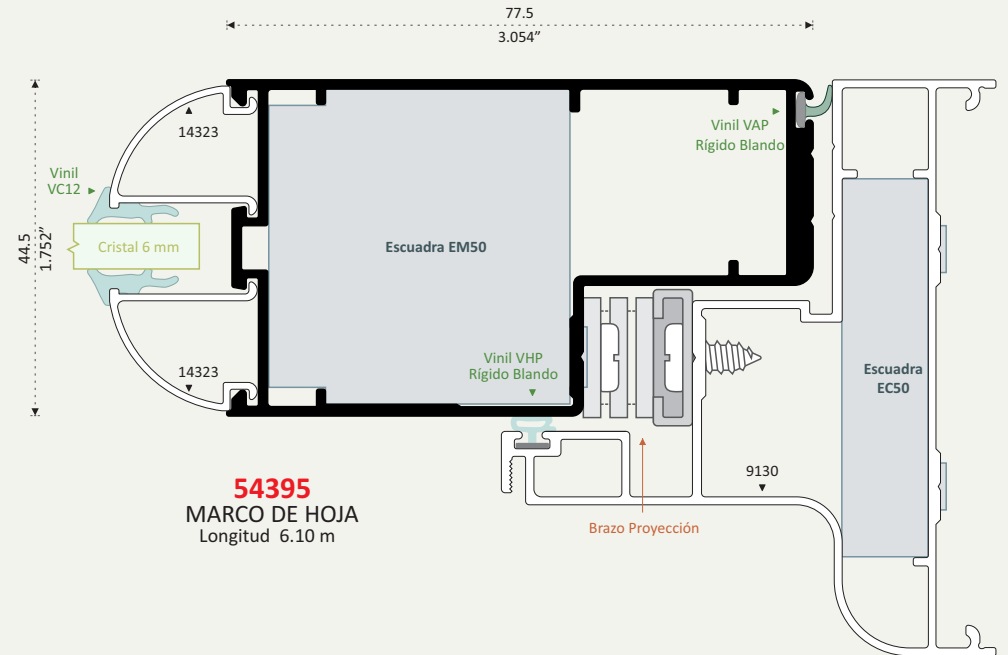

AJUSTA Y CIERRA EL CORTE



Contramarco 9130 con Escuadra EC50



AJUSTA Y CIERRA EL CORTE

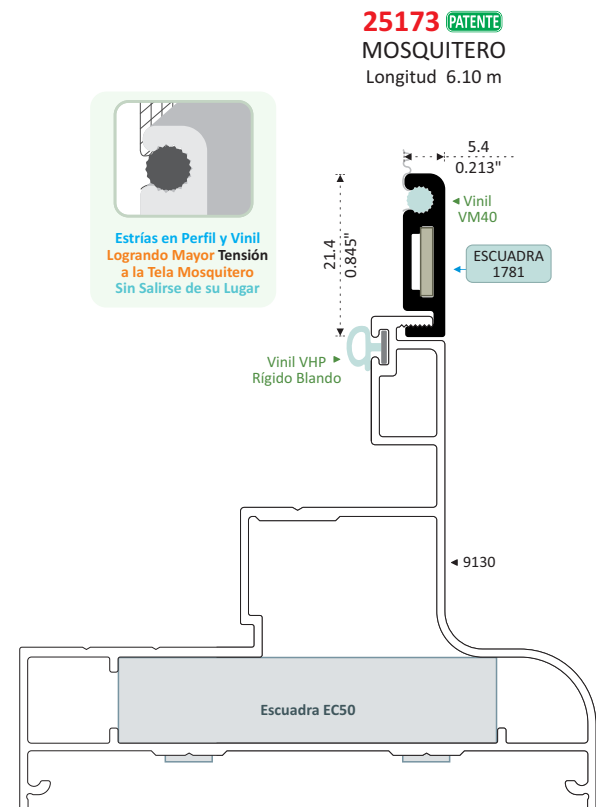

VINIL RESPALDO

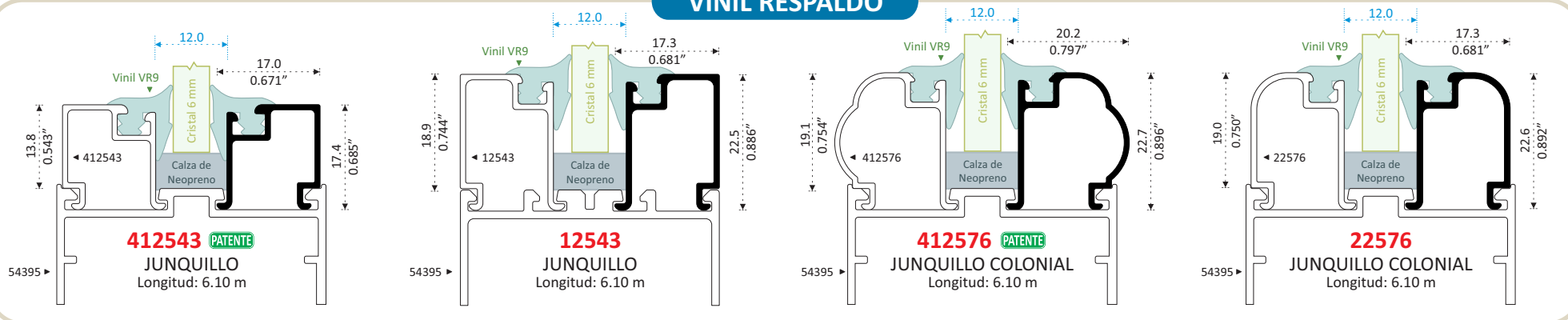

VINIL CUÑA

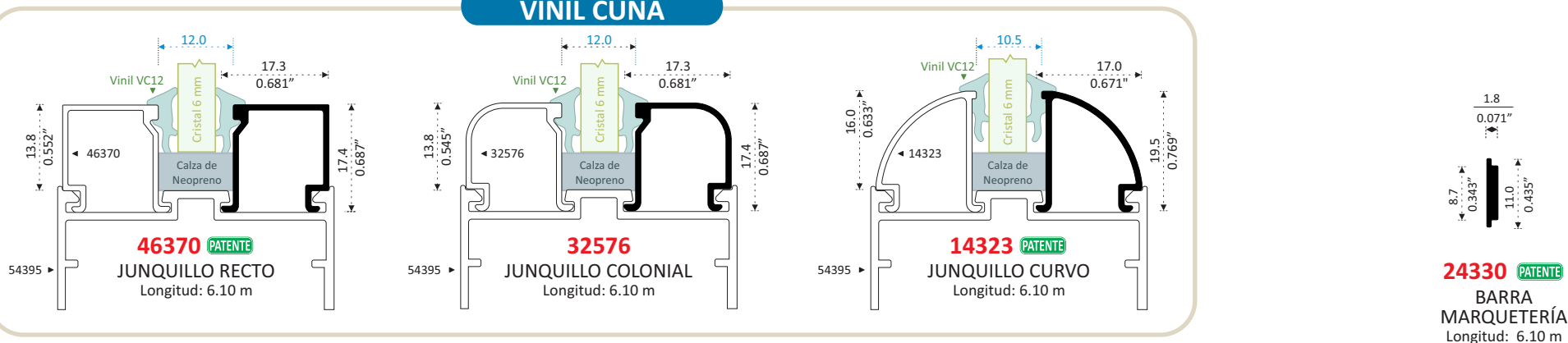

VINIL INTERIOR

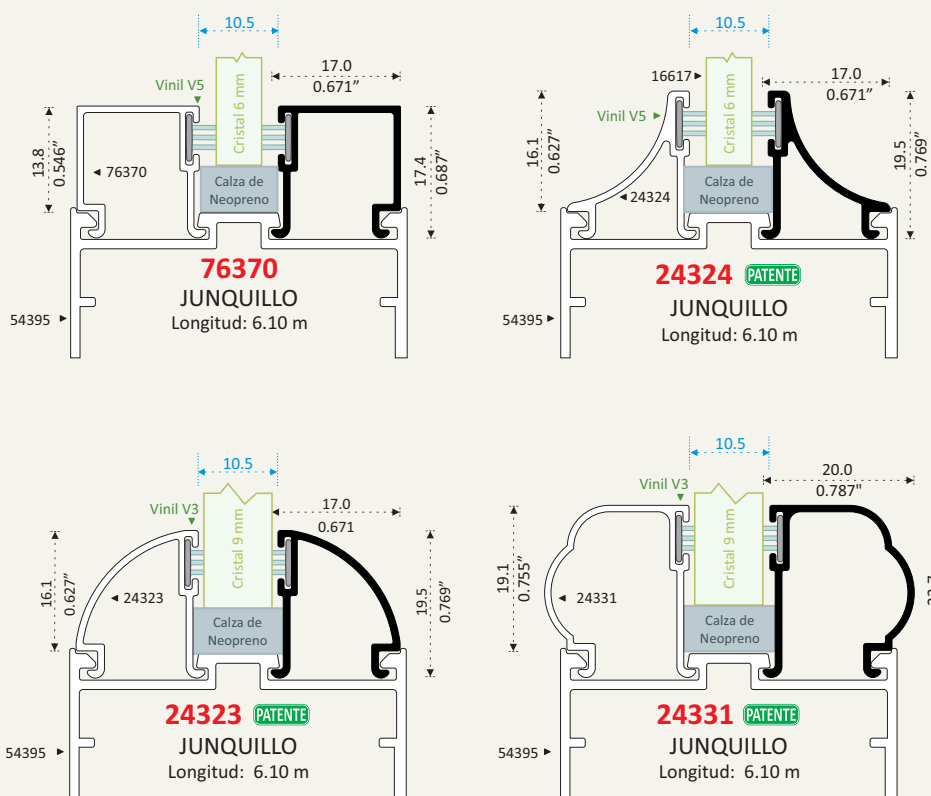

MARQUETERÍA

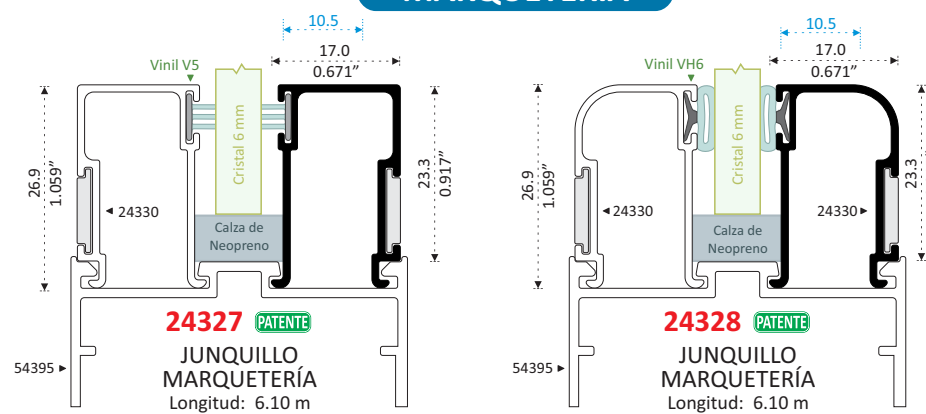

CRISTAL DOBLE

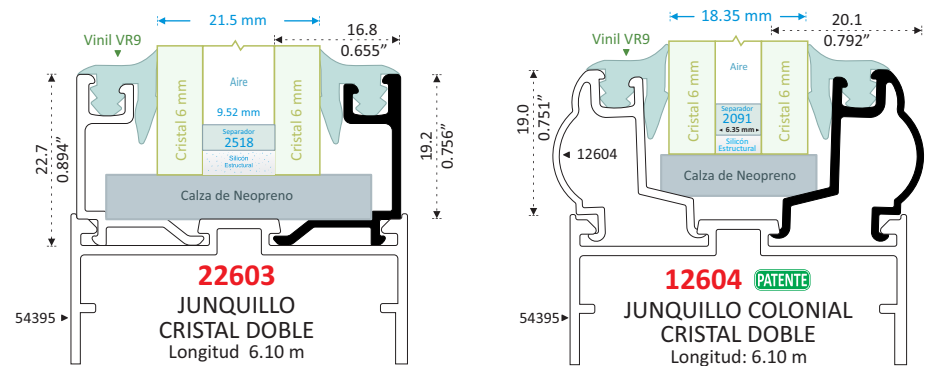

VENTANA GUILLOTINA 3"

Convierte un Producto Perfiletto **En Extraordinario**

Vinil Hongo en Traslapes
Aumenta Hermeticidad a:
Polvo, Ruido y Viento

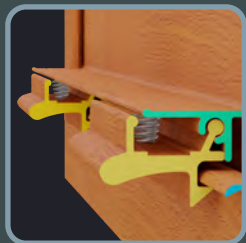

2 Broches Jaladeras
al Cierre

Salida de Agua Eficiente
Por su Inclinación

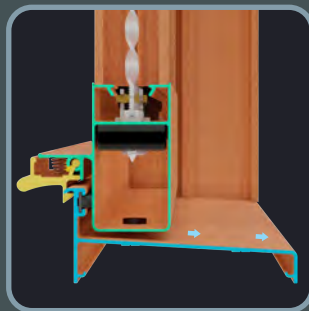

Desplazamiento Suave
Que Permite Detener en
Cualquier Parte del Recorrido



Cierre Suave
por Esquina
Redondeada

Juego de Herraje Incluye:

Piezas Superior con Tapón



- Mantiene el Balancín en Vertical
- Oculta la Pija por su Tapón
- Tope en Apertura Máxima



Guías Centrales con Felpa



- En Apertura y Cierre:
- Sin Juego de Hoja Móvil
 - Fijación Directa Sin Ajuste
 - Suave Desplazamiento por sus Felpas Laterales



Guías Inferiores con Felpa

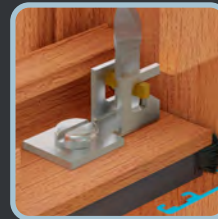

- En Apertura y Cierre:
- Sin Juego de Hoja Móvil
 - Fijación Directa Sin Ajuste
 - Suave Desplazamiento por sus Felpas Laterales
 - Refuerza el Atornillado del Bracket



Descubre otras Opciones para tu Cancelería



Mosquitero
Fijo

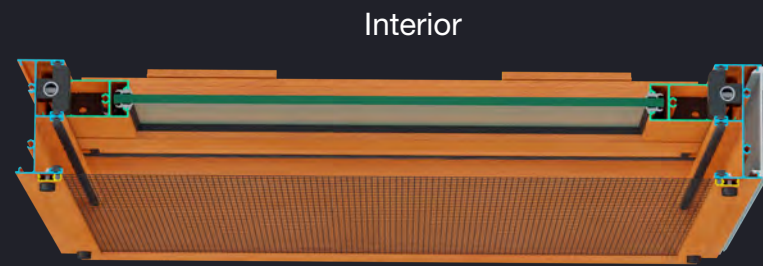

Interior

Exterior

Ensamble
de la Línea
con
Moldura Unión

■ Aislamiento Acústico Con 67848 39.2 Decibles

■ Permeabilidad a Viento y Polvo Con 67848 Aire que Detiene 83 %

■ Resistencia A Vientos Sin Deformar el Perfil 120 Km/h

AISLAMIENTO ACÚSTICO

REALIZADO CON 120 DECIBELES AL EXTERIOR
MEDIDA 1.00 x 1.00 m

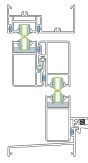

AISLAMIENTO
39.2
Decibeles
CRISTAL DE 6 mm

LÍNEA EXCLUSIVA PERFILETTO

PERMEABILIDAD AL AGUA DURANTE 20 MINUTOS

VENTANA MEDIDA 1.00 x 1.00 m

VELOCIDAD KM/H	Agua	Aire
20	50%	50%
40	50%	50%
60	50%	50%
80	50%	50%
100	50%	50%
120	60%	40%

SIN MOSQUITERO
Sin Filtraciones

MOSQUITERO FIJO 67333
Sin Filtraciones

MOSQUITERO FIJO 7336
Sin Filtraciones

Otros Mosquiteros Fijos Ocasianan Filtraciones
Por su Altura Mayor Respecto al Riel

PERMEABILIDAD AL VIENTO

Medida 1.00 x 1.00 m

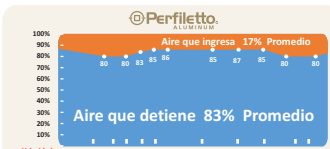

LÍNEA EXCLUSIVA PERFILETTO



RESISTENCIAS A VIENTOS

VENTANA

Prueba Realizada
30 Repeticiones de 1 Minuto c/u
A 120 Km/h

Medida 1.00 x 1.00 m
Cristal 6 mm

LOS PERFILES SIN DEFORMACIÓN CONSERVAN SU FUNCIONAMIENTO

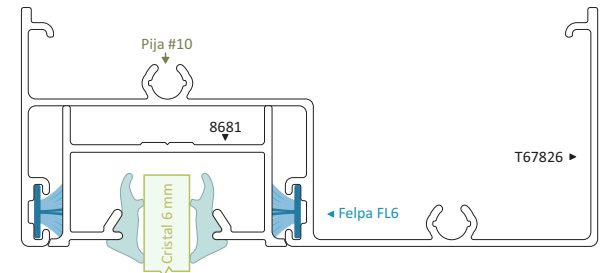

15.3
0.604"

Tapón TCP6

Vinil VM40

5.3
0.209"

11763

MOSQUITERO FIJO
Longitud 6.10 m

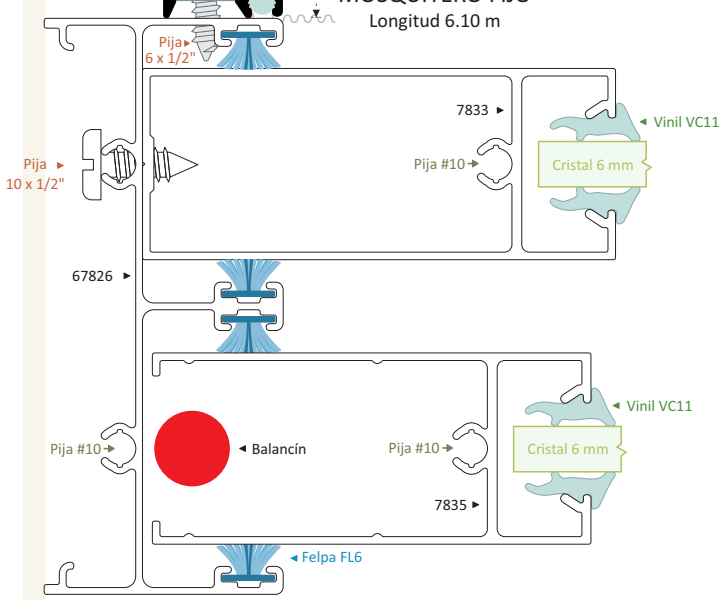

MAYOR HERMETICIDAD: AL AIRE, POLVO Y RUIDO POR SU VINIL VH4 EN TRASLAPE

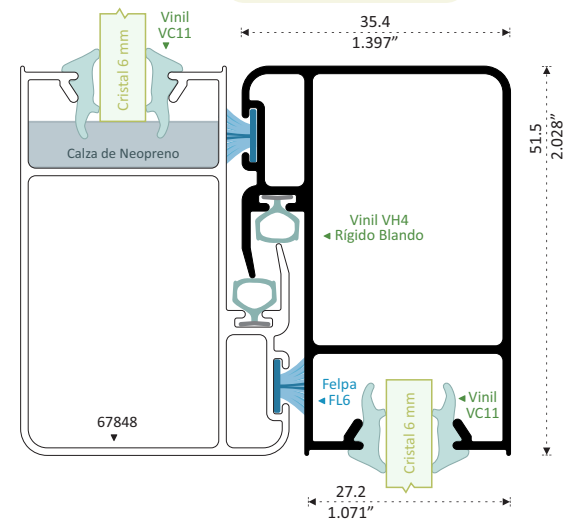

67848 PATENTE
TRASLAPE
Longitud 4.60 m
67848-5.1 5.10 m
67848-L 6.10 m



8565
REPIZÓN GUILLOTINA
Longitud 6.10 m
8565-C 3.05 m

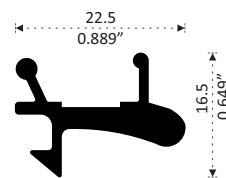

8563
BROCHE JALADERA
Longitud 6.10 m

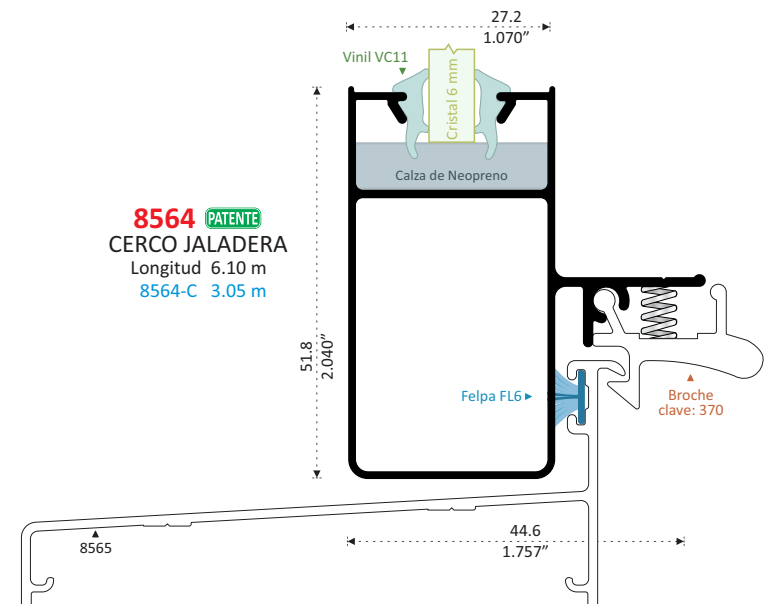

8564 PATENTE
CERCO JALADERA
Longitud 6.10 m
8564-C 3.05 m

79.9
3.148"

Línea 3" Sifón

Convierte un Producto Perfiletto En Algo Extraordinario

Línea que Permite Mayor Vista y Ventilación



Vista de Bolsa con Cubierta Bolsa

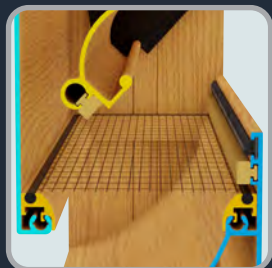

Mosquitero Horizontal Oculto

Colocación por el Exterior

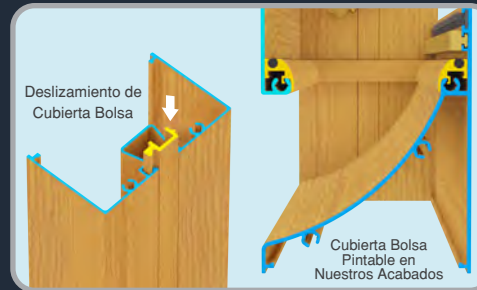

Cubierta Bolsa

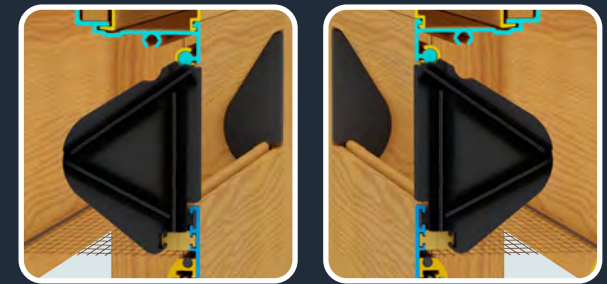

Sello Hermético por sus 2 Tapas Laterales de 3 Felpas con Aletas

Cierre con Imanes



Descubre otras Opciones para tu Cancelería

Poste Intermedio Listo para Ensamblar



Cabezal Liso

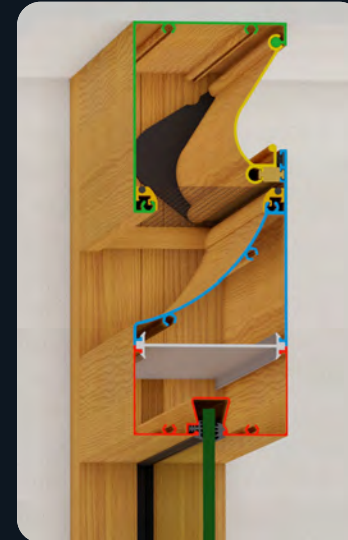

Cristal Doble



■ Aislamiento Acústico
Cristal Sencillo 45.2 Decibles
Cristal Doble 45.4 Decibles

■ Permeabilidad a Viento y Polvo
Aire que Detiene 99 %

■ Resistencia A Vientos Sin Deformar el Perfil 120 Km/h

AI SLAM IENTO ACÚSTICO
 REALIZADO CON 120 DECIBELES AL EXTERIOR
 MEDIDA 1.00 x 1.00 m

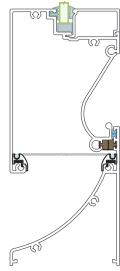

SIFÓN CRISTAL SENCILLO

AI SLAM IENTO

Vinil VCA Vinil VPC8 Clave: FLS Comercial Juego Tapas S3 Imán ICC

DIVISIÓN TEXTIL 7 mm 5 mm

45.2
Decibeles

8%
Más Eficiente

Perfiletto ALUMINUM

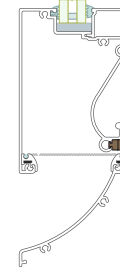

SIFÓN CRISTAL DOBLE 6mm + SEPARADOR 2091 + 6mm

AI SLAM IENTO

Vinil VCA Vinil VPC8 Clave: FLS Comercial Juego Tapas S3D Imán ICC

DIVISIÓN TEXTIL 7 mm 5 mm

45.4
Decibeles

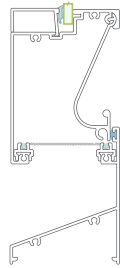

AI SLAM IENTO

Vinil VC11 Clave: FG Comercial Juego Sifón

DIVISIÓN TEXTIL 7 mm 5 mm

42.2
Decibeles

OTROS COMPETIDORES

LÍNEA EXCLUSIVA PERFILETTO

PERMEABILIDAD AL AGUA DURANTE 20 MINUTOS

SIFÓN MEDIDA 1.00 x 1.00 m

VELOCIDAD KM/H	Agua	Aire
20	50%	50%
40	50%	50%
60	50%	50%
80	50%	50%
100	50%	50%
120	60%	40%

MOSQUITERO FIJO 20554

Sin Filtraciones

PERMEABILIDAD AL VIENTO Medida 1.00 x 1.00 m

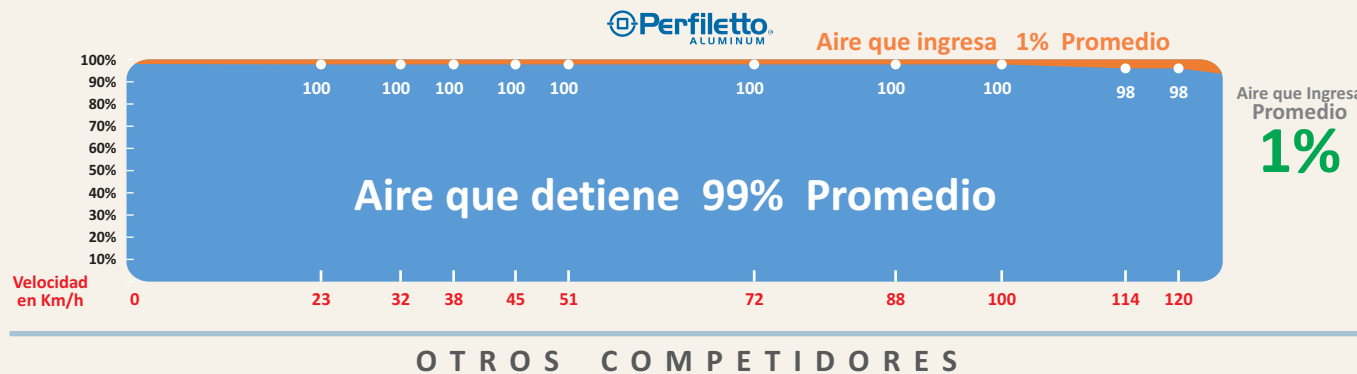

COMPETIDORES

CERRADA INGRESA ALTAS CANTIDADES DE AIRE Y POLVO

RESISTENCIAS A VIENTOS

VENTANA

Prueba Realizada
 30 Repeticiones de 1 Minuto c/u
 A 120 Km/h

Medida 1.00 x 1.00 m
 Cristal 6 mm

LOS PERFILES SIN DEFORMACIÓN
 CONSERVAN SU
 FUNCIONAMIENTO

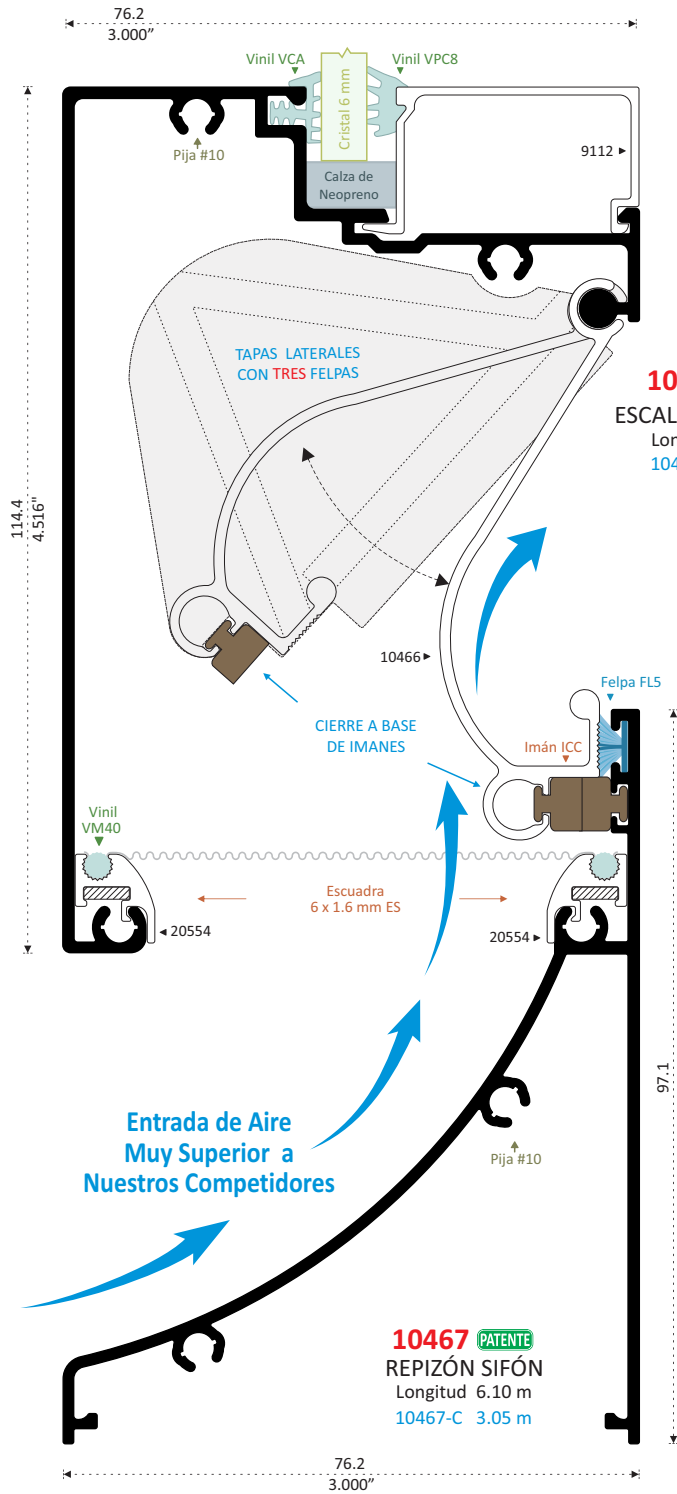

10465 PATENTE
ESCALONADO SIFÓN
 Longitud 6.10 m
 10465-C 3.05 m

**Aumenta la Hermeticidad Acústica,
 Colocando Vinil por Ambos Lados**

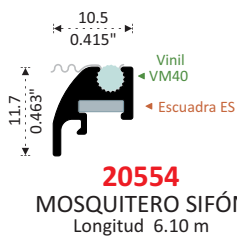
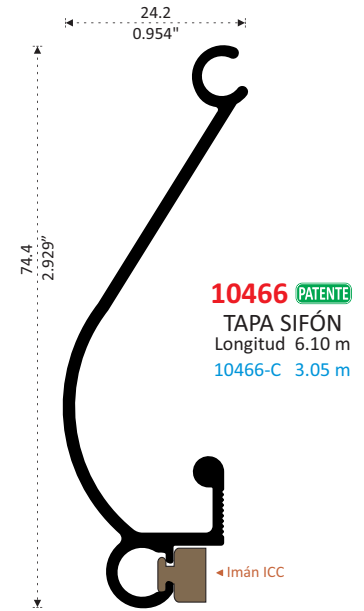

MOSQUITERO SIFÓN CON MAYOR VENTILACIÓN

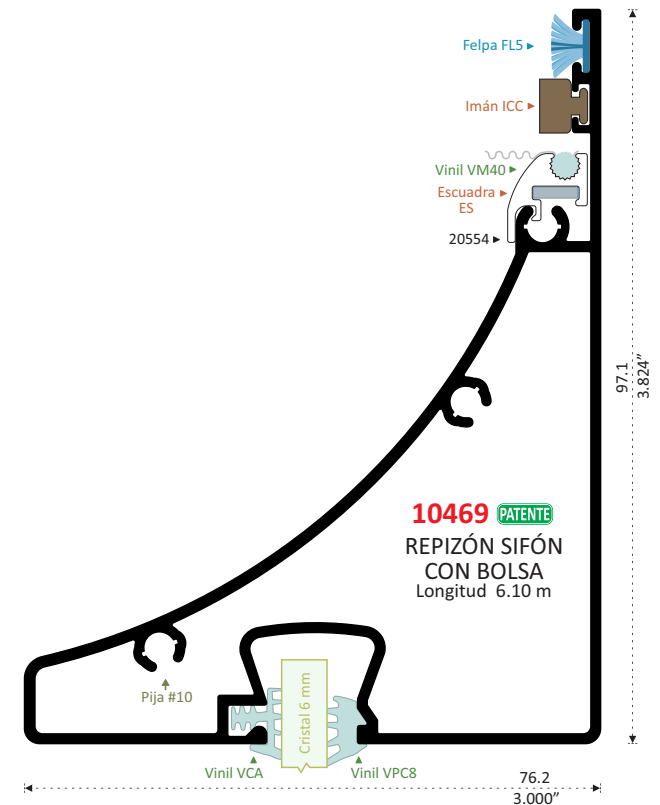

Ancho Máximo Sugerido por Cajón : 1.50 m.

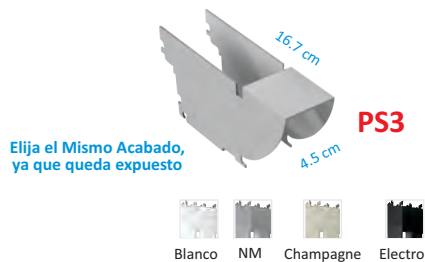

Probada en Nuestro Centro de Investigación y Desarrollo a 200 Km/h Logrando una Gran Hermeticidad

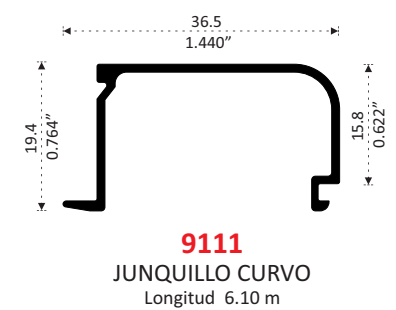
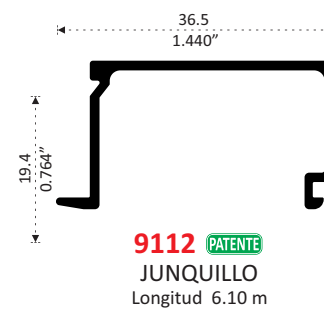

**Aumenta la Hermeticidad Acústica,
Colocando Vinil por Ambos Lados**

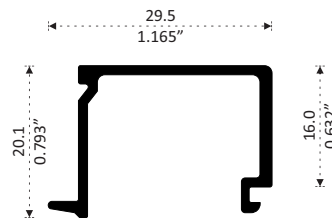
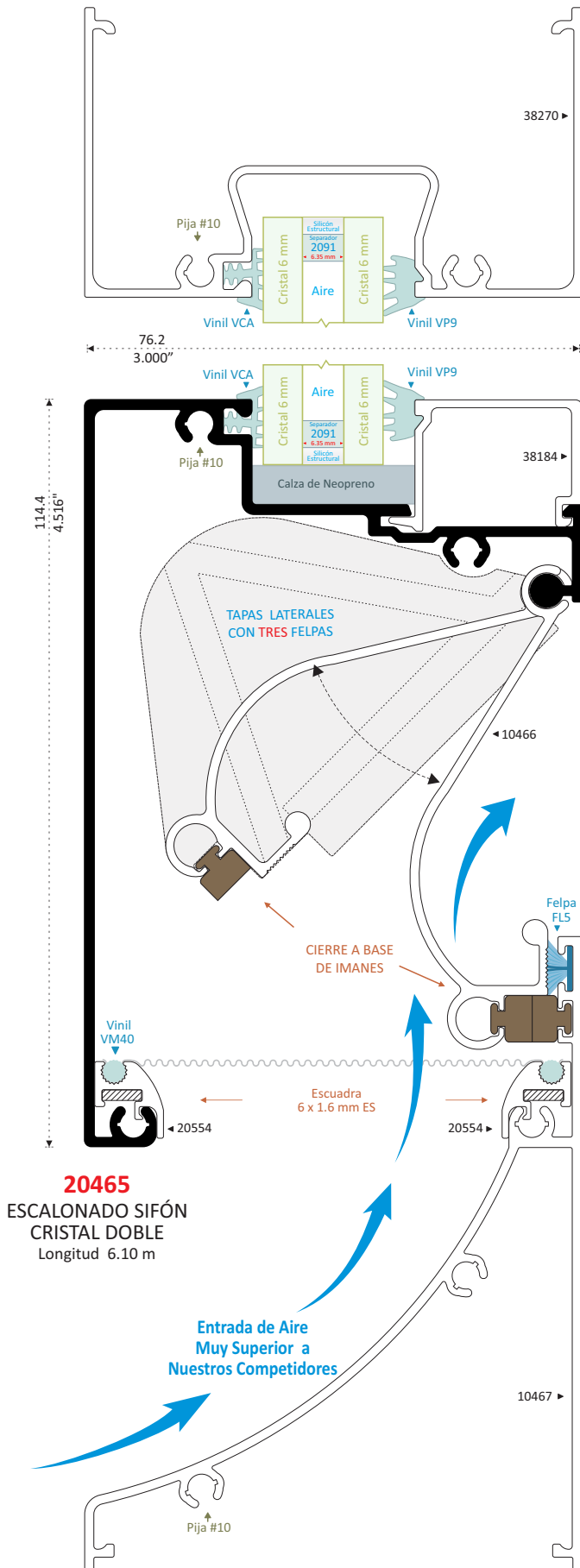

Probada en Nuestro Centro de Investigación y Desarrollo a 200 Km/h Logrando una Gran Hermeticidad



S3D
Herrajes para Sifón de 3"

- Incluye:
- * Tapas Laterales Izquierda y Derecha
 - * Cubiertas Bolsa Aluminio Anodizado
 - * Felpas con Labios de Plástico

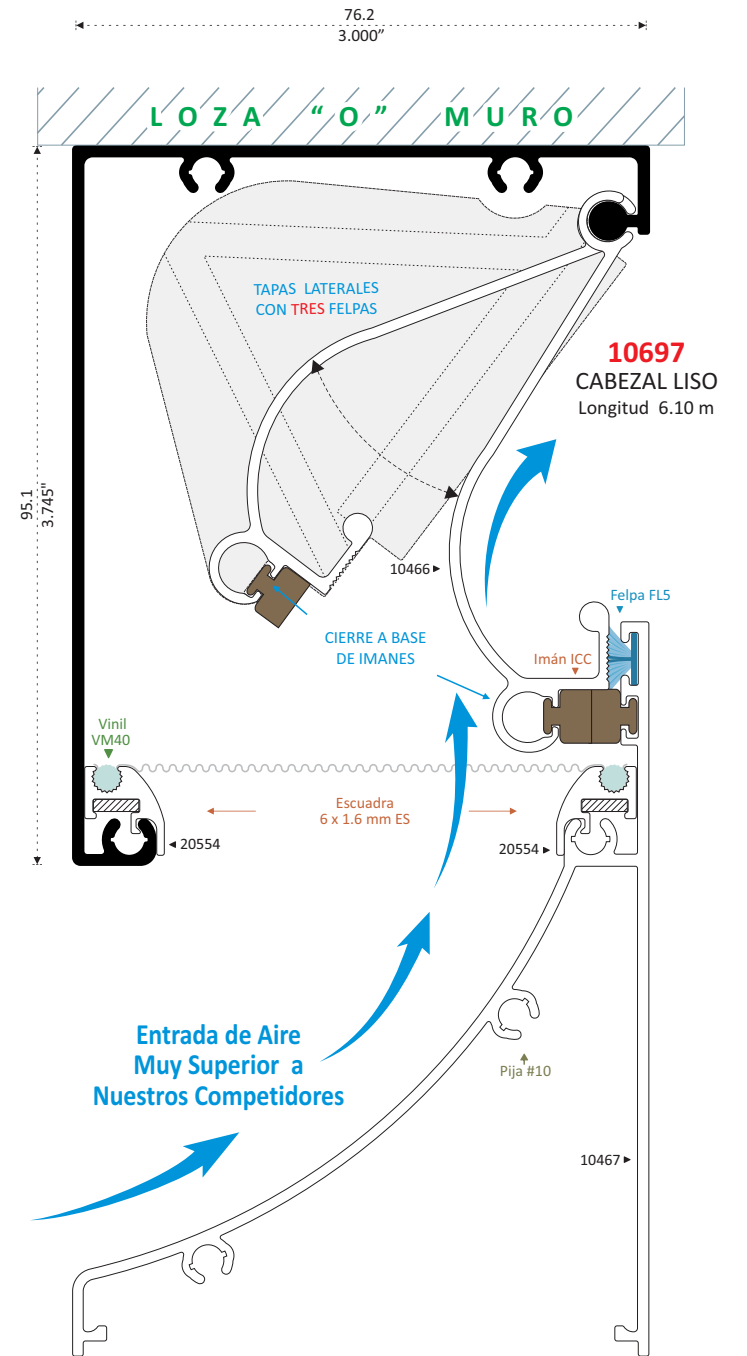

Ancho Máximo Sugerido por Cajón : 1.50 m.

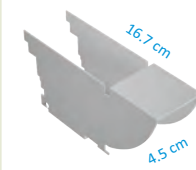

PS3D
Soporte Intermedio 3"
Cristal Doble



Elige el Mismo Acabado, ya que queda expuesto

Puerta Batiente Multidiseños

Convierte un Producto Perfiletto En Algo Extraordinario



Hermeticidad y Aislamiento entre Batiente y Cabezal por sus 6 Felpas

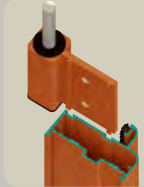

Deslizable en Batiente

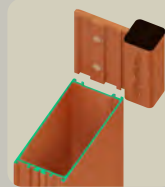

Deslizable Cerco Chapa

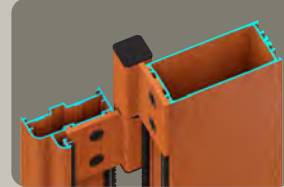

1523P



1525P



1522P

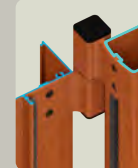

1524L

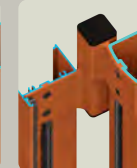

1524F

Las Barras de Armado

Trabajan a la Tensión y Compresión

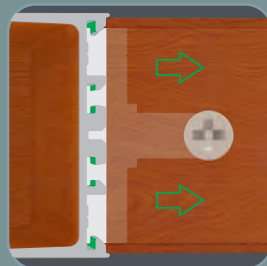
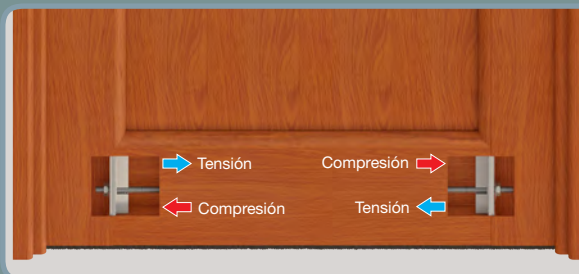

● Paredes de Esfuerzo a la Tensión

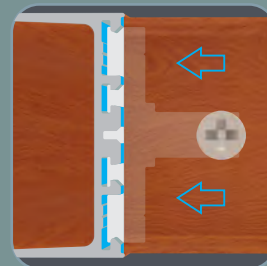

● Paredes de Esfuerzo a la Compresión

Hermeticidad y Aislamiento Por sus 3 Felpas

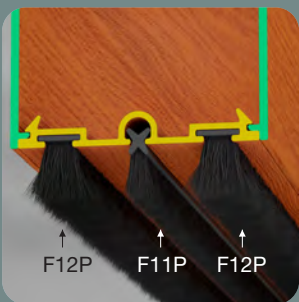

Fijación de Barra con Opresores de Punta en Acero Inoxidable

Opresores para Mayor Rapidez en el Armado

Instalación de Tapa Lisa



Instalación del Batiente

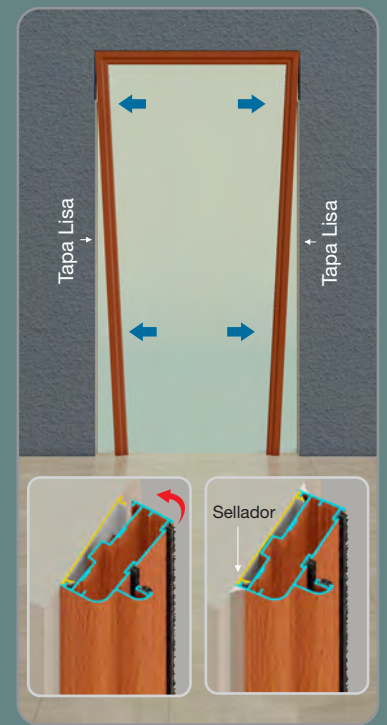

Las Barras de Armado

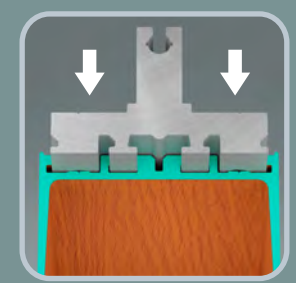

Se Desliza en Cercos

■ Aislamiento Acústico

Duela-Duela 37.4 Decibles
Cristal-Duela 38.3 Decibles
Cristal-Cristal 41.3 Decibles

■ Permeabilidad a Viento y Polvo

Con 9204
Con 412542

Aire que Detiene 83 %
Aire que Detiene 85 %

■ Resistencia A Vientos Sin Deformar el Perfil

Puerta 120 Km/h

Puerta Batiente Multidiseños

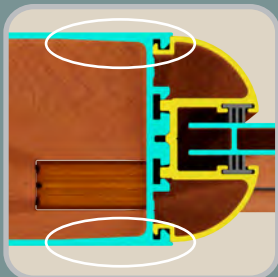

Cerco Chapa con Refuerzos en Paredes Interiores Dando Resistencia al Apretar el Tensor



Escuadra en Armado de Batientes con Corte a 45°

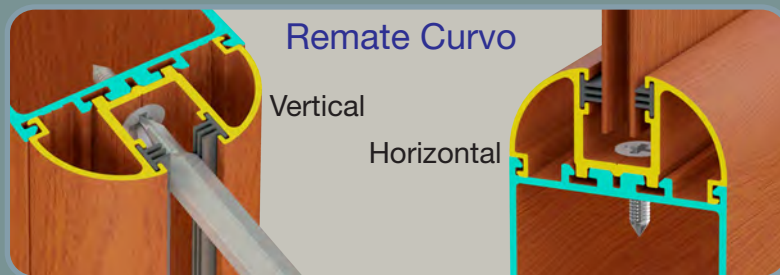

Remate Curvo

Vertical

Horizontal

Alta Resistencia

- Al Impacto
- Entrada Forzada
- Fuertes Ráfagas de Vientos

20 Opciones de Junquillos

Vinil Cuña

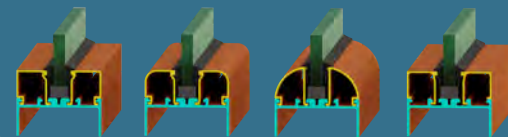

Vinil Respaldo



Vinil Interior



Cristal Doble



Descubre otras Opciones para tu Cancelería

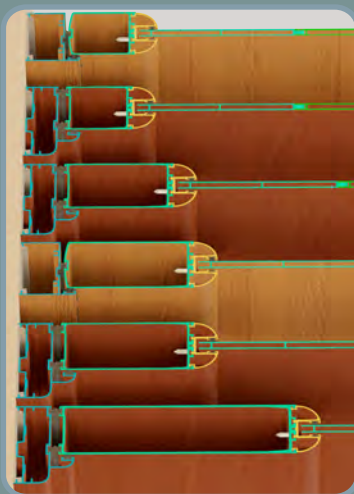

Cercos Chapa

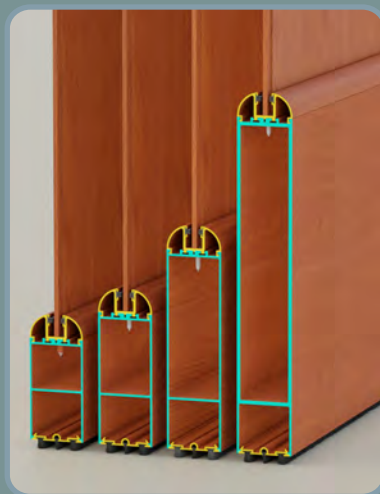

Zoclos

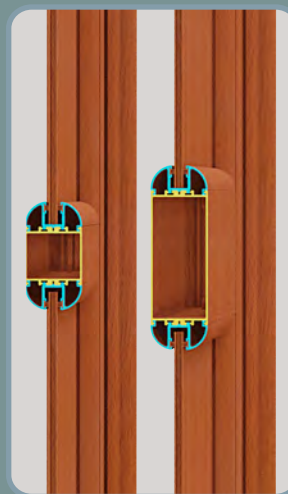

Intermedios

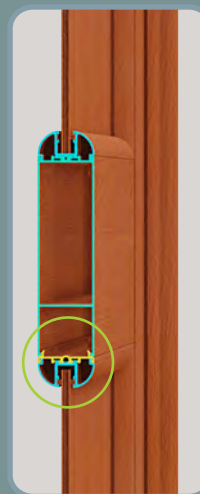

Elige tu Intermedio con el Adaptador

Puerta Batiente Multidiseños

SOLISTAS



COLONIAL

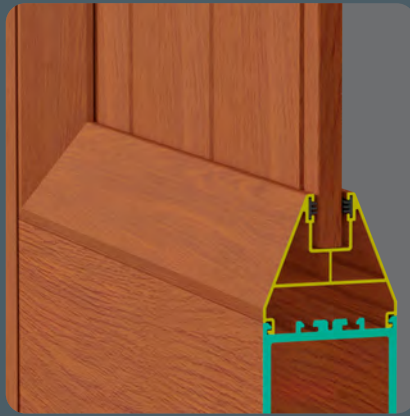

BISELADA

RECUBRIMIENTOS A MURO



COLONIAL

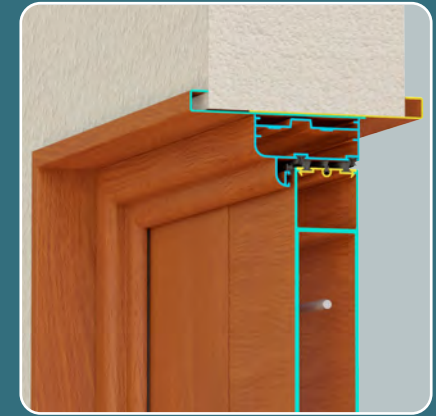

RECTO

RELIEVE COLONIAL

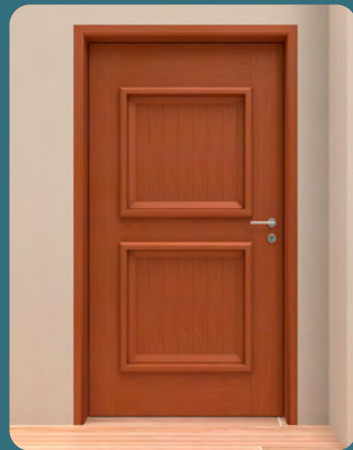

DISEÑA EL INTERIOR DE TU PUERTA



BRAZOS BISAGRA HIDRÁULICA DE PISO



Colocación Superior



Colocación Inferior

BRAZOS BISAGRA HIDRÁULICA AÉREA



Colocación Superior



Colocación Inferior

BATIENTES INTERMEDIOS

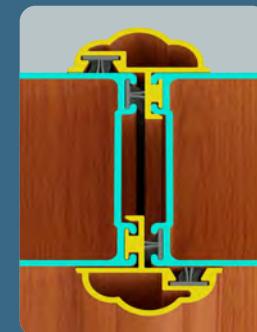

Colonial

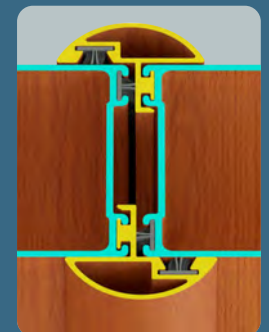

Curvo



AISLAMIENTO ACÚSTICO

REALIZADO CON 120 DECIBELES AL EXTERIOR MEDIDA 0.95 X 2.20 m

DUELA 16617
AISLAMIENTO 37.4
 Decibeles

Cerco Chapa 412542
 Junquillo 24323

DUELA 16617
AISLAMIENTO 32.9
 Decibeles

Cerco Chapa 412544
 Junquillo 24323

CRISTAL 6 mm
AISLAMIENTO 38.3
 Decibeles

Cerco Chapa 412542
 Junquillo 24323

DUELA 16617
AISLAMIENTO 36.6
 Decibeles

Cerco Chapa 412544
 Junquillo 24323

CRISTAL 6 mm
AISLAMIENTO 41.3
 Decibeles

Cerco Chapa 412542
 Junquillo 24323

CRISTAL 6 mm
AISLAMIENTO 39.9
 Decibeles

Cerco Chapa 412544
 Junquillo 24323

COMPETIDOR

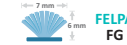

AISLAMIENTO 30.8
 Decibeles

AISLAMIENTO 33.2
 Decibeles

AISLAMIENTO 36.7
 Decibeles

PERMEABILIDAD AL AGUA

DURANTE 20 MINUTOS

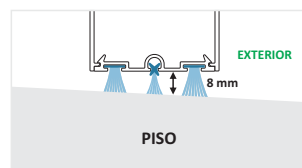

Desnivel de Piso 3° Grados

Sin Filtraciones

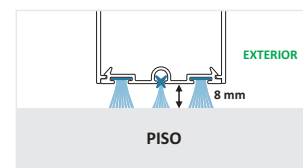

Desnivel de Piso 0° Grados

Con Filtraciones

PERMEABILIDAD AL VIENTO Medida 1.00 x 1.00 m

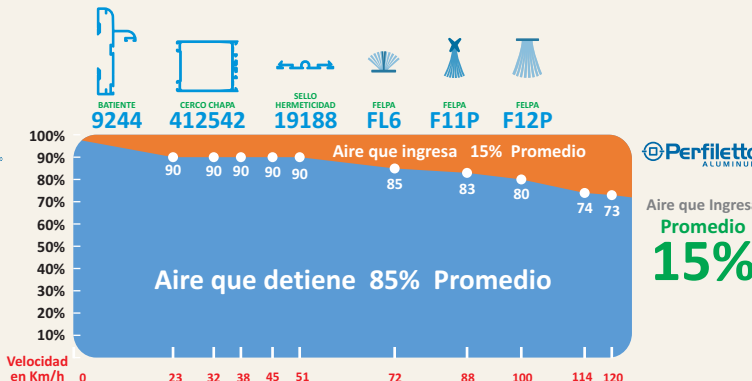
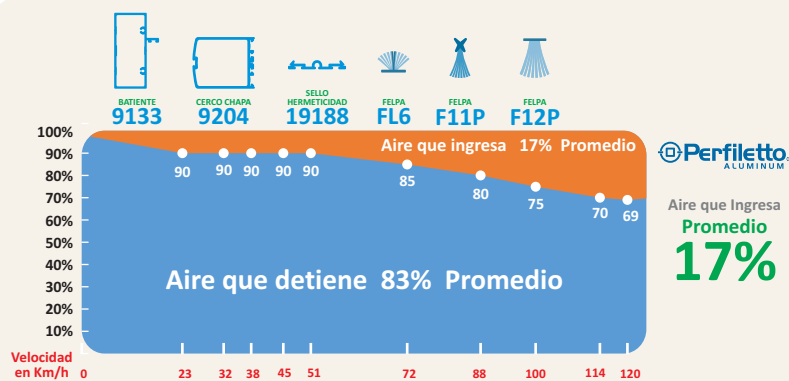

RESISTENCIAS A VIENTOS

PUERTA

Prueba Realizada
30 Repeticiones de 1 Minuto c/u
A 120 Km/h
Medida 0.95 X 2.20 m
Crystal 6 mm
Duela 16617

LOS PERFILES SIN DEFORMACIÓN
CONSERVAN SU
FUNCIONAMIENTO

COMPETIDOR

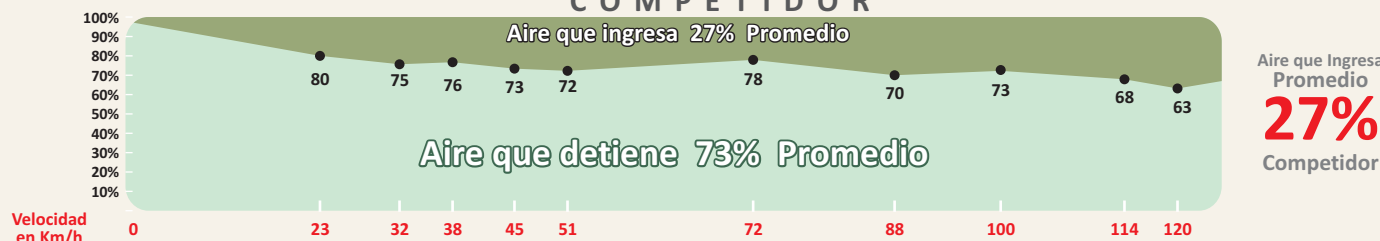



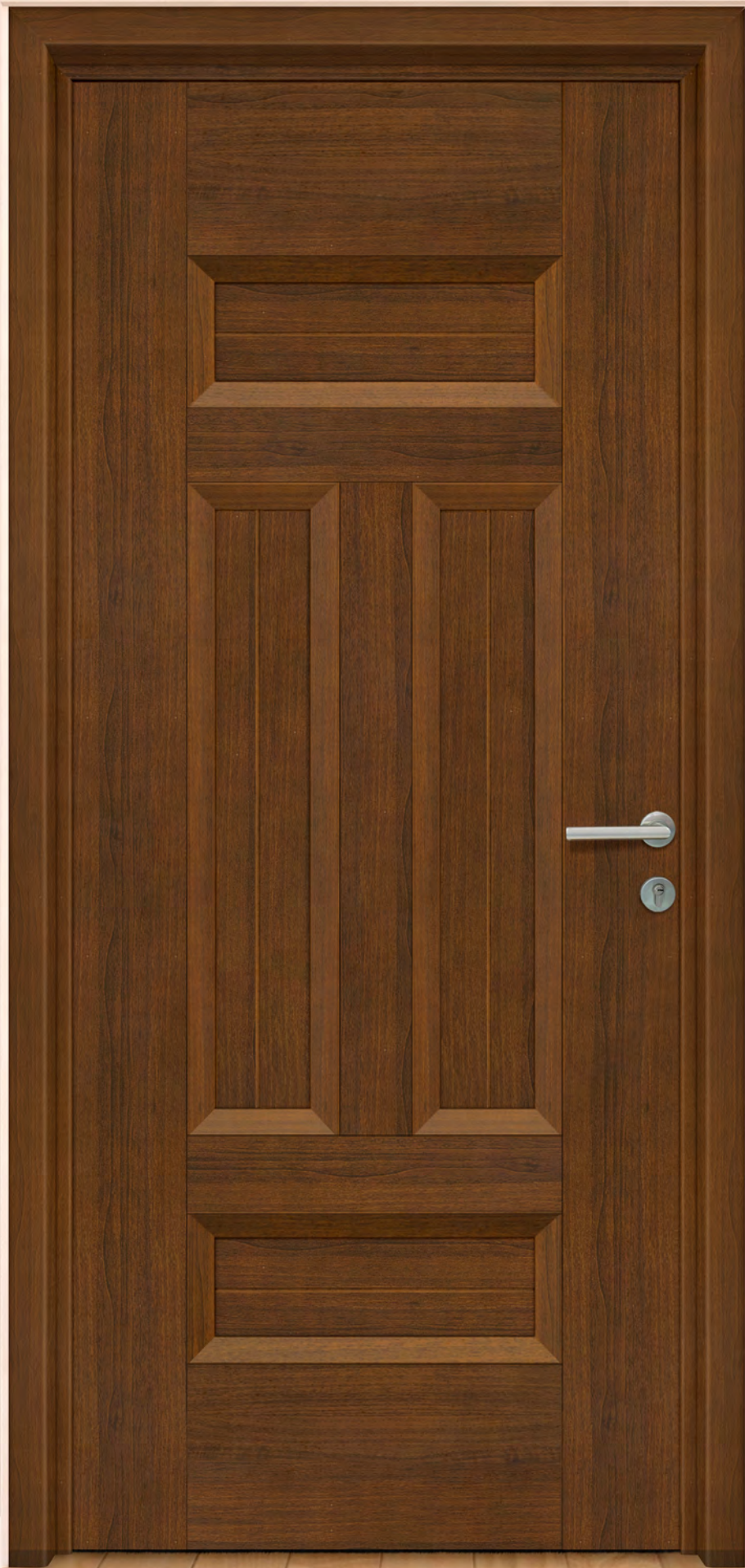

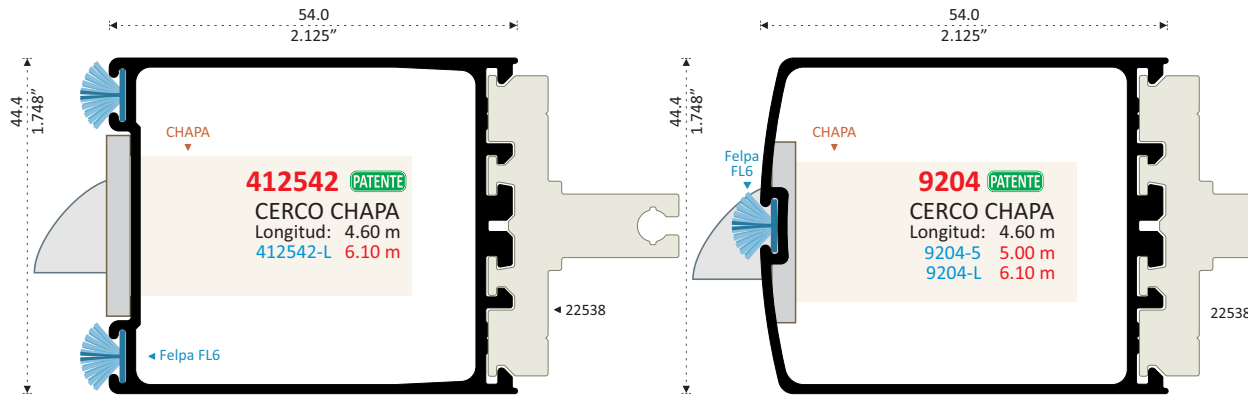

INSTALACIÓN EN: CERCOS, INTERMEDIOS Y ZOCLOS

SISTEMA DE ARMADO REFORZADO BARRA ALTA

Colocar Tensor en Medidas Mayores a 1 m

412542 Opresores

Pija Acero Inox.

Tensor de 3/8"

Barras de Armado Rápido con Opresores de Punta en Acero Inoxidable

39.8 1.567"

Pija #10

25.2 0.993"

Armado con Tensor

Barras de Armado

Instalación con Remaches	Incluye Opresores Allen
BA33 9207, 9183, 9187	BO33 9187, 9207
BA57 19187	BO57 19187
BA92 412602	BOi92 412602
BA107 412596	BO107 412596
BA183 412597	BOi33 9183
BA207 412599	BO207 412599

22538 PATENTE
BARRA DE ARMADO Longitud: 3.03 m
BA1M 1 metro

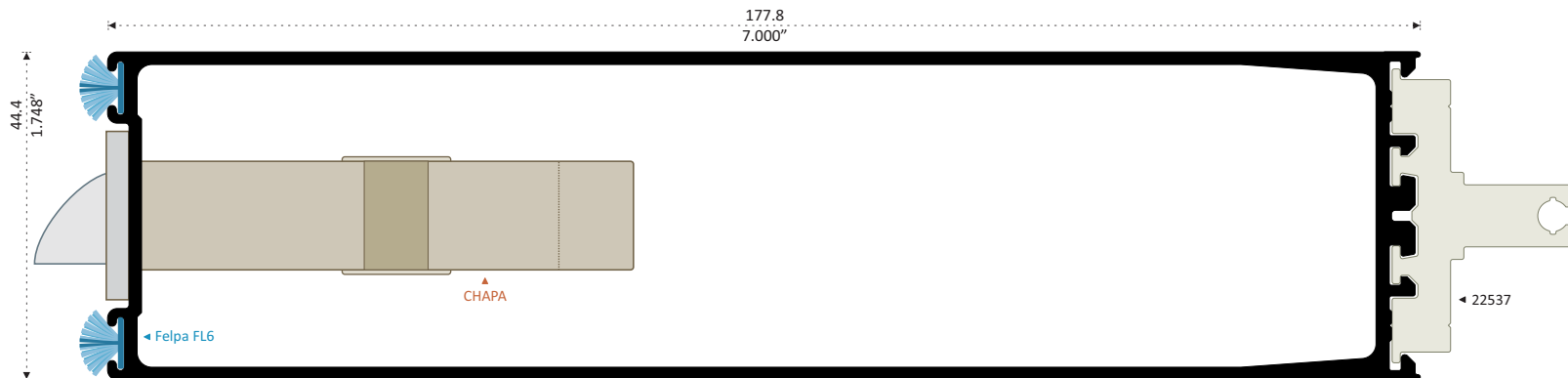
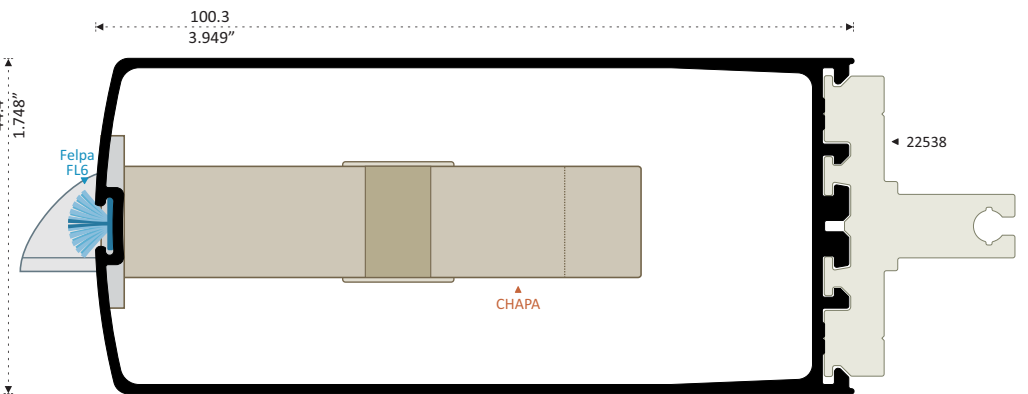
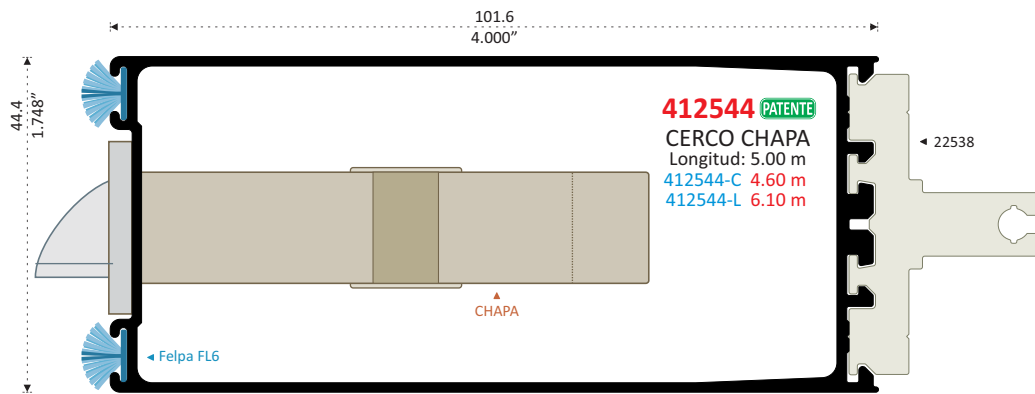
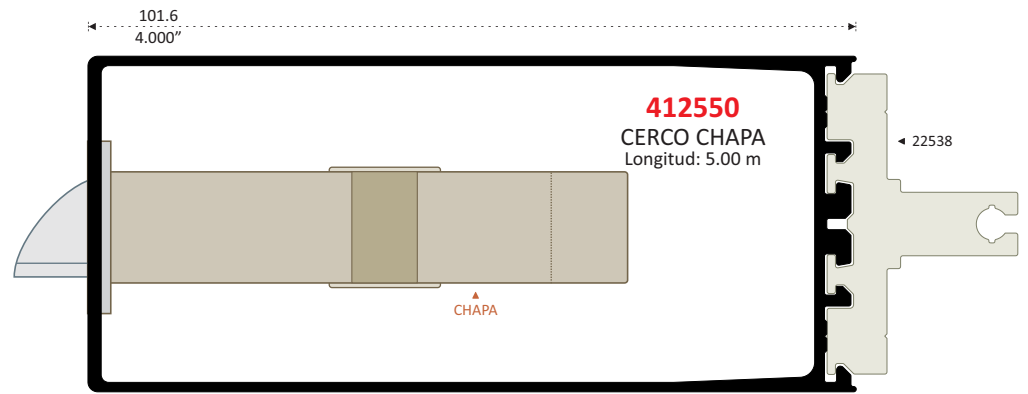
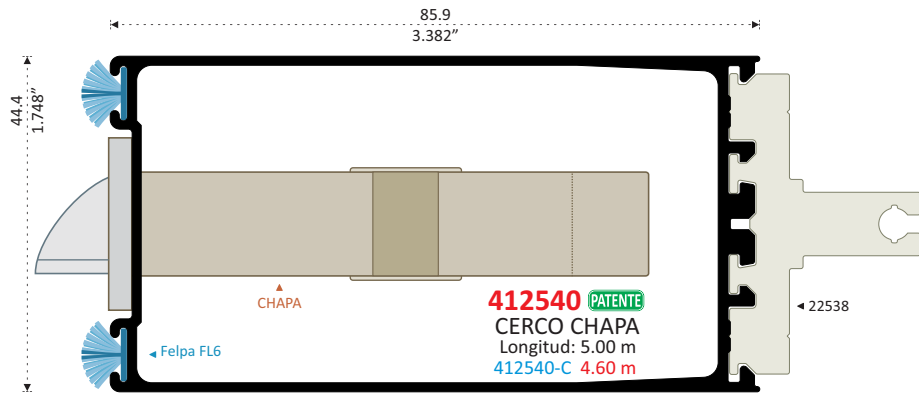

46901 PATENTE
CERCO CHAPA Longitud: 5.00 m

412545 PATENTE
CERCO CHAPA Longitud: 5.00 m
412545-C 4.60 m
412545-L 6.10 m

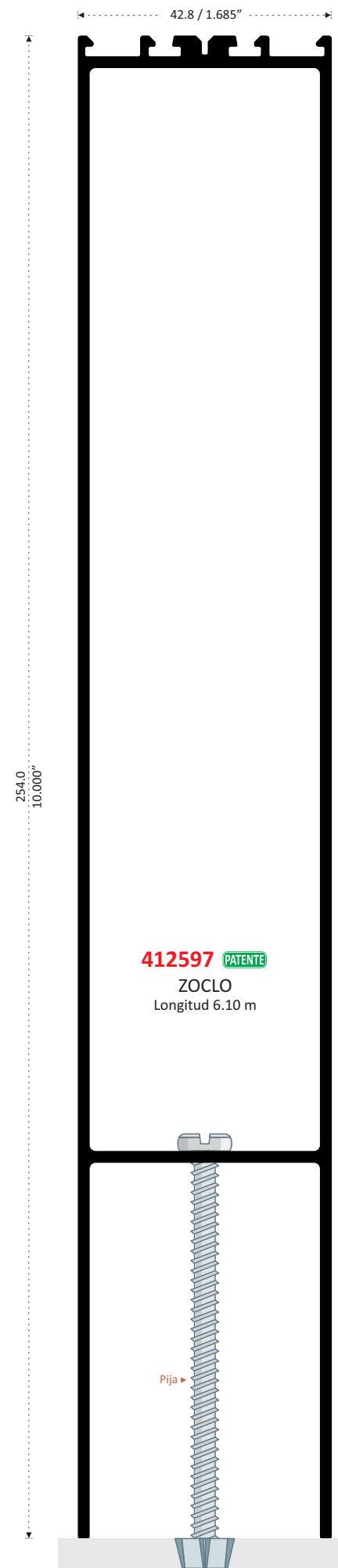
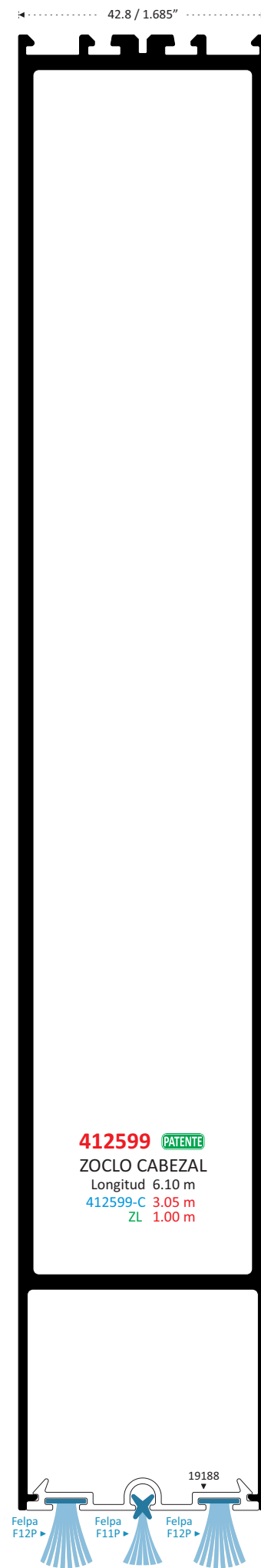
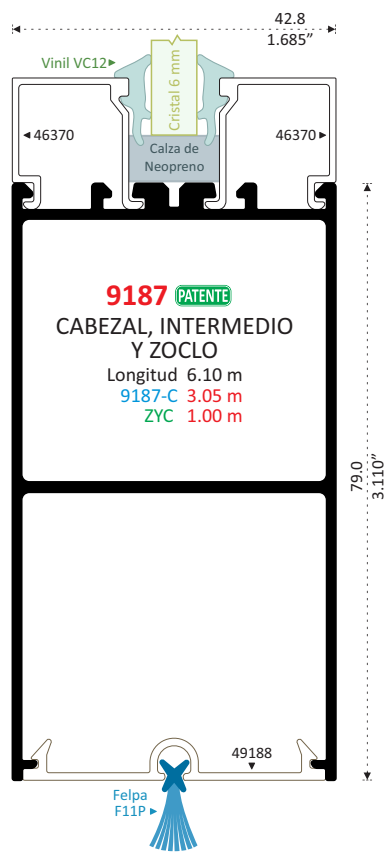
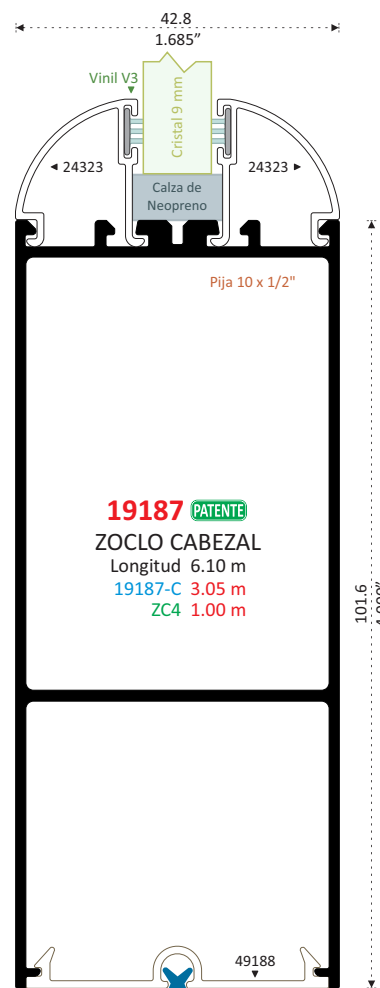
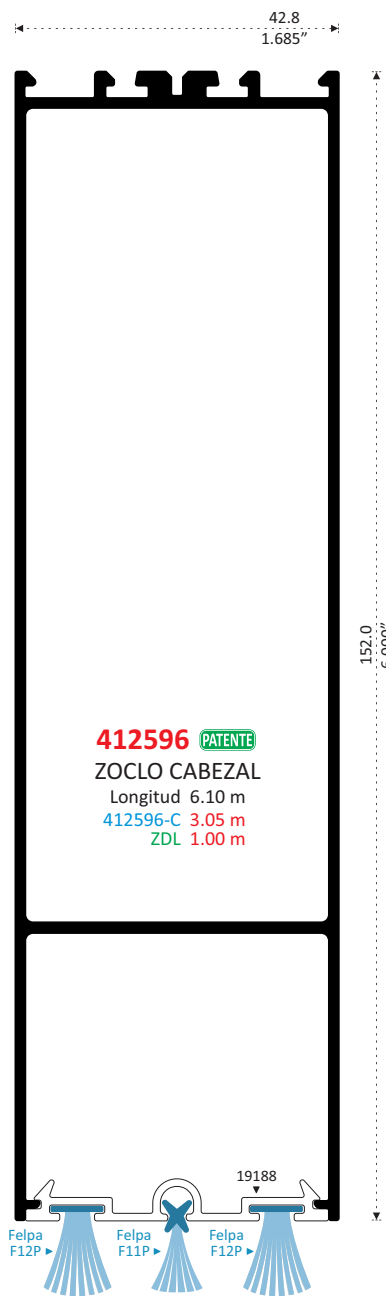
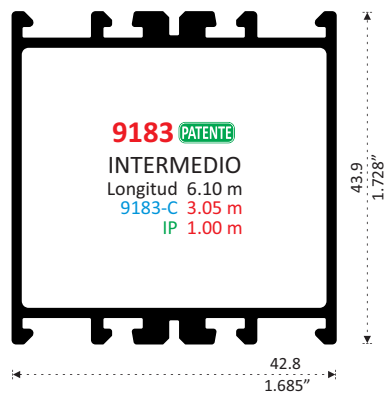
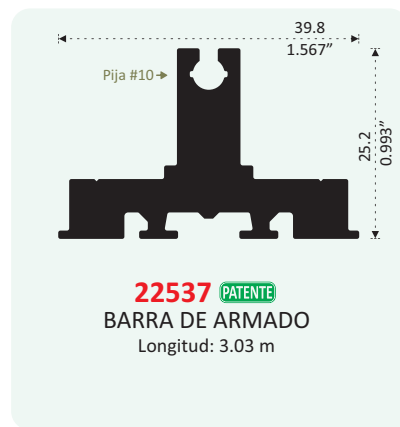
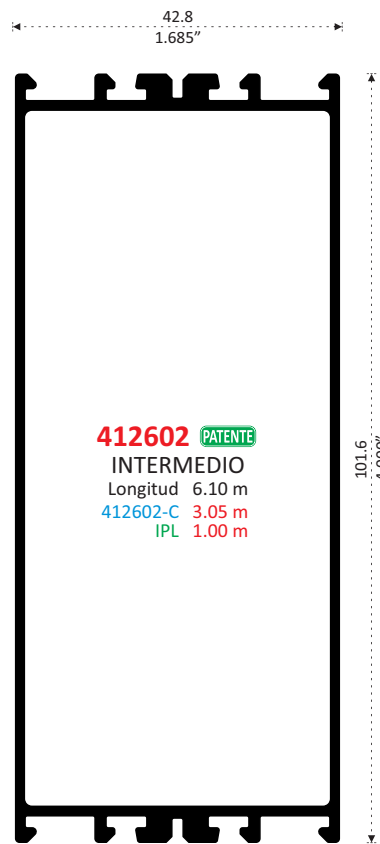
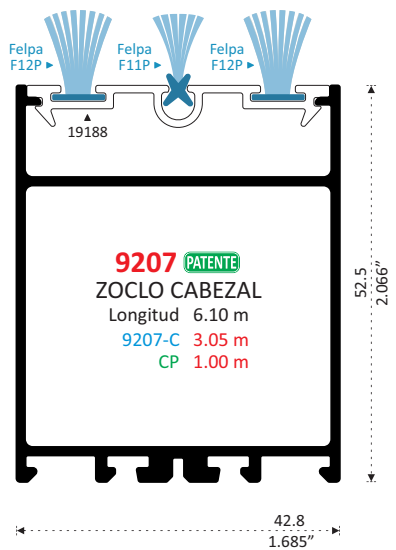

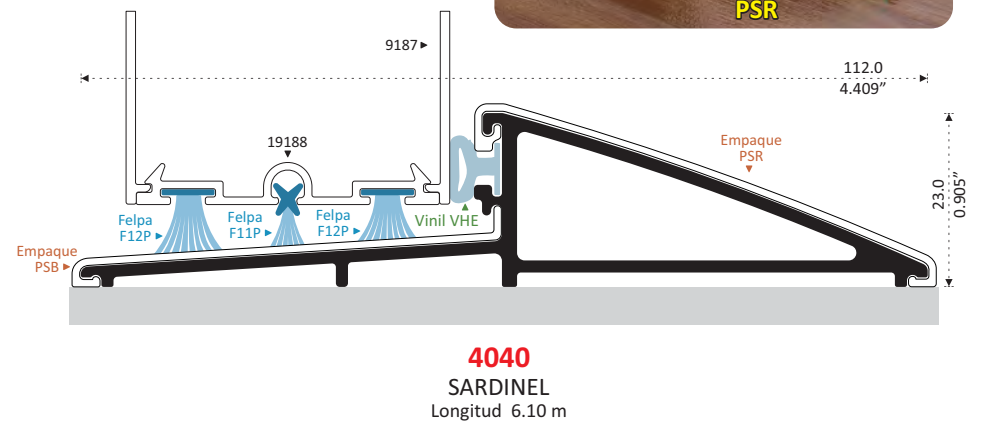
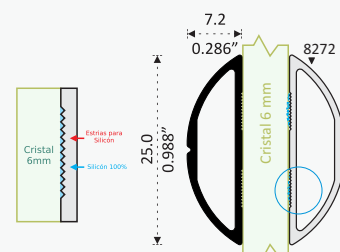
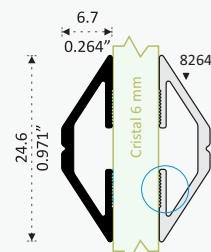
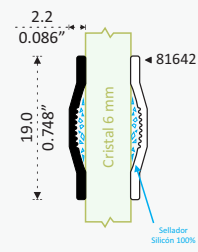
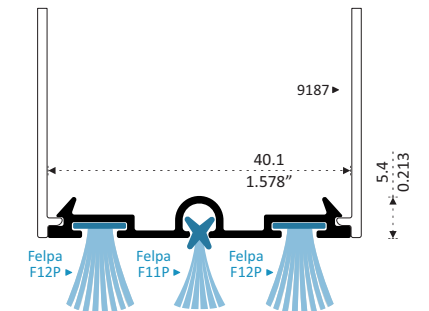
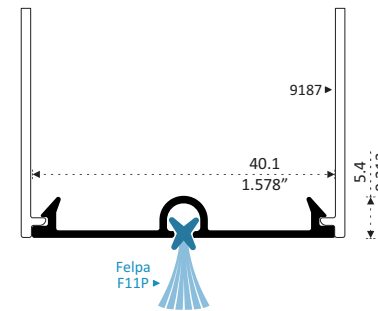
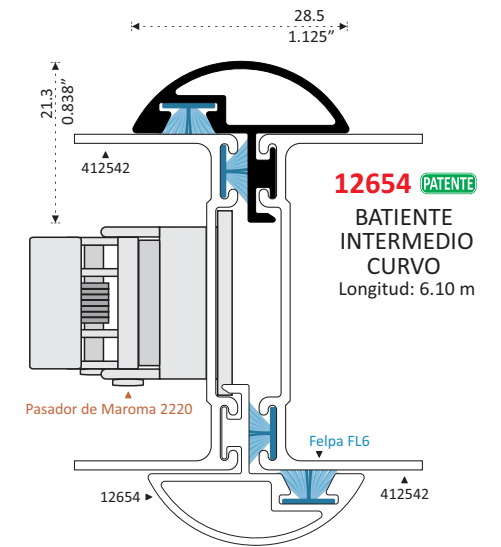
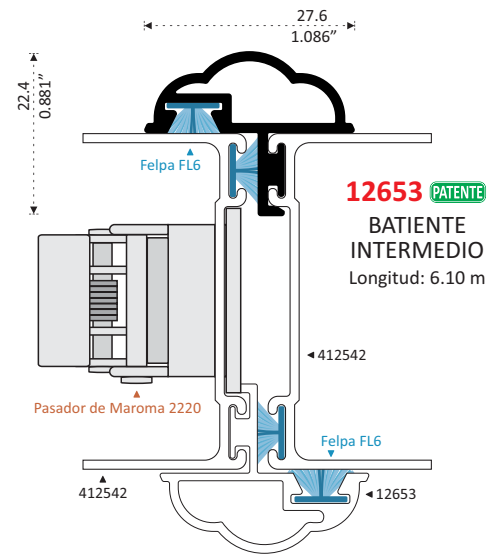
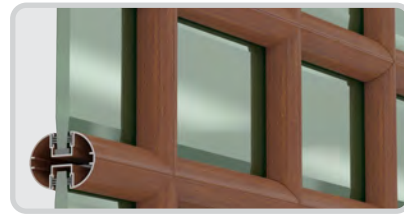
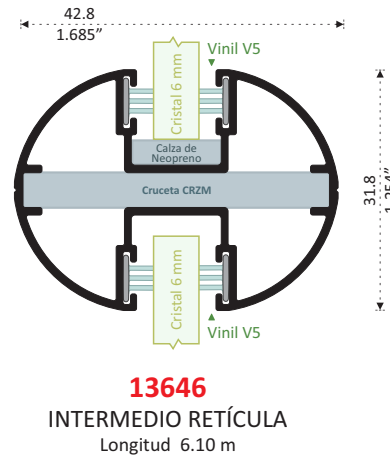
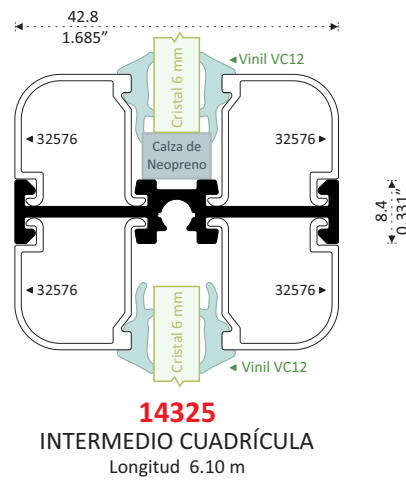
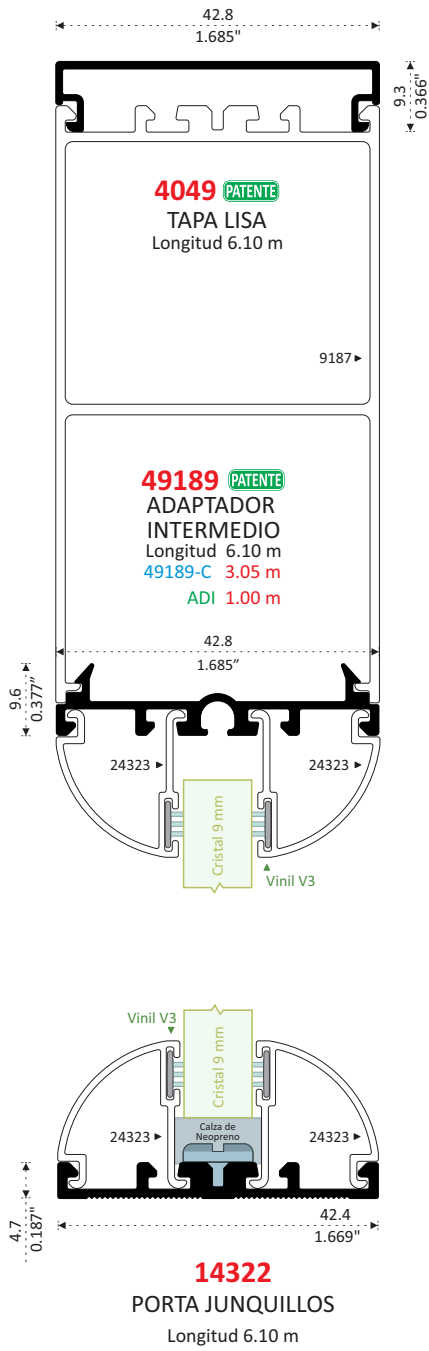

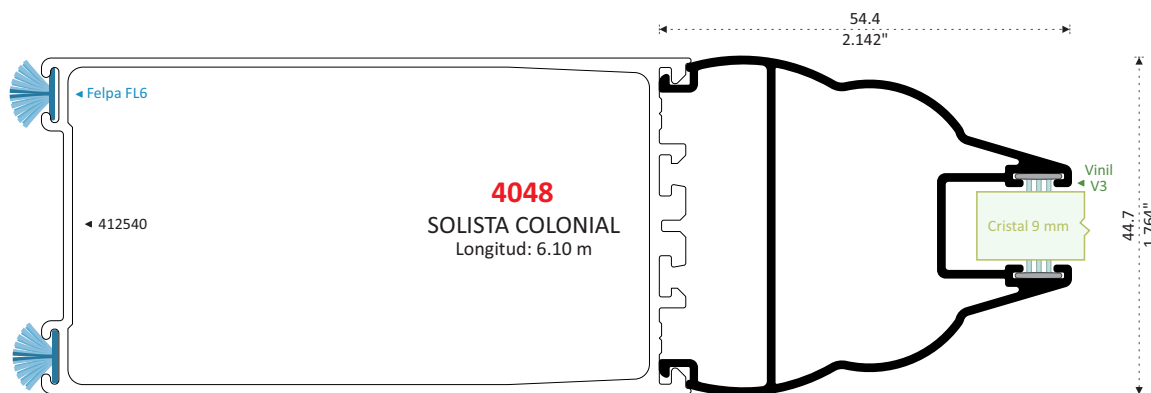
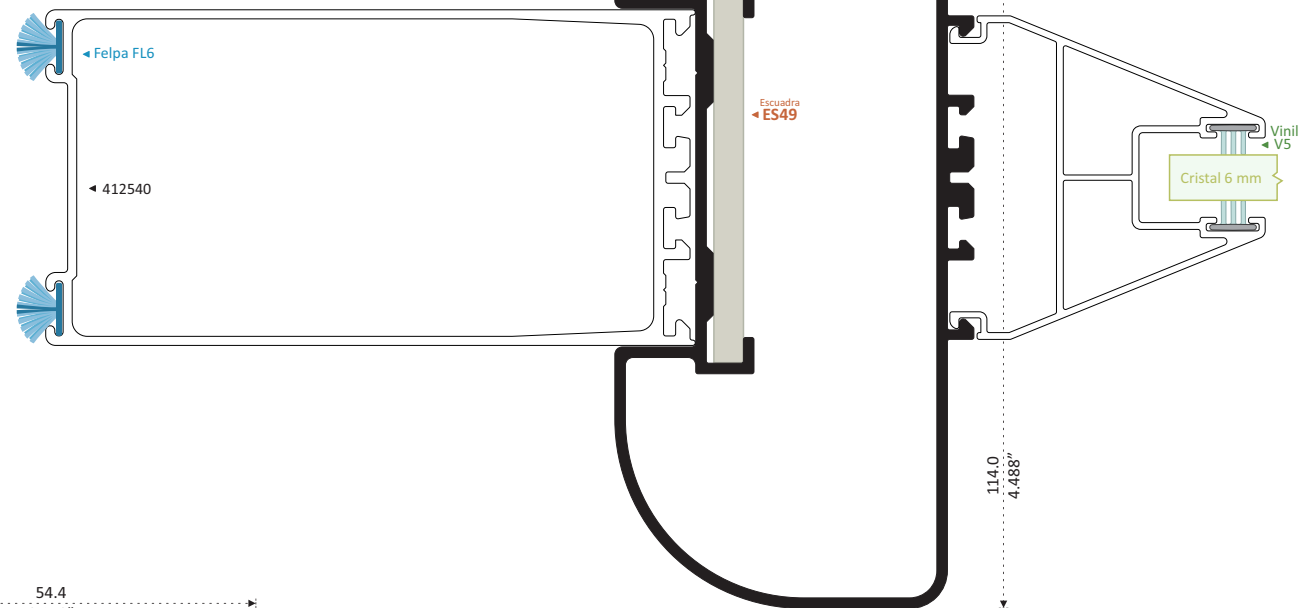
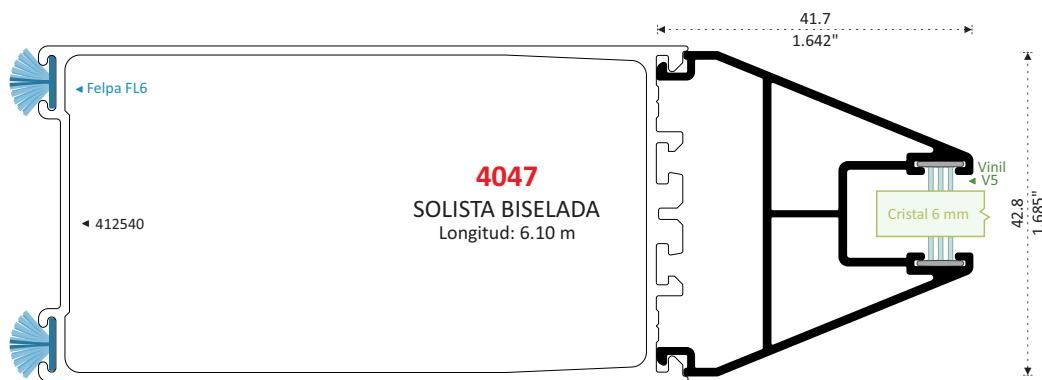

JUNQUILLOS

VINIL CUÑA

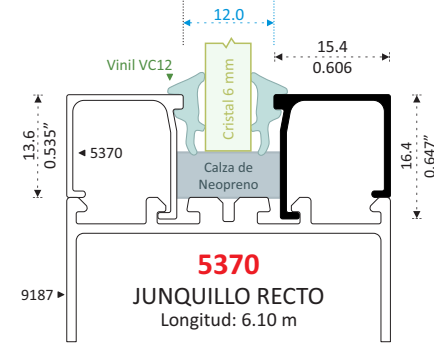
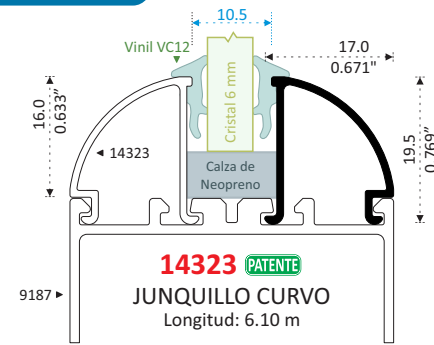
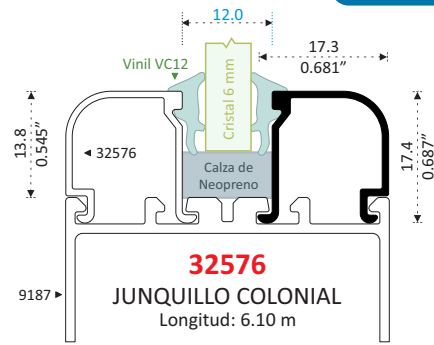
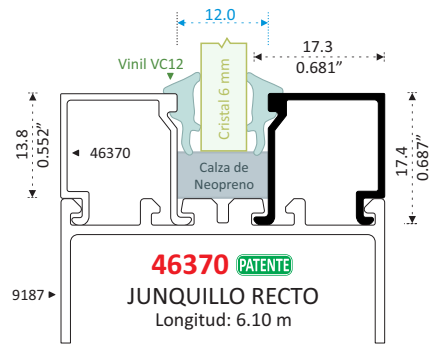

VINIL RESPALDO

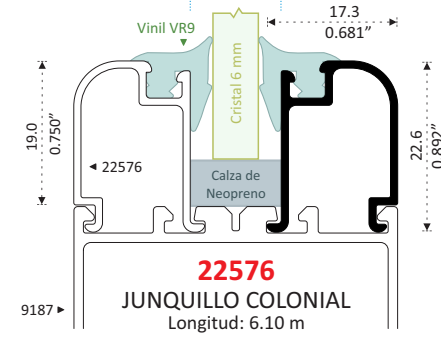
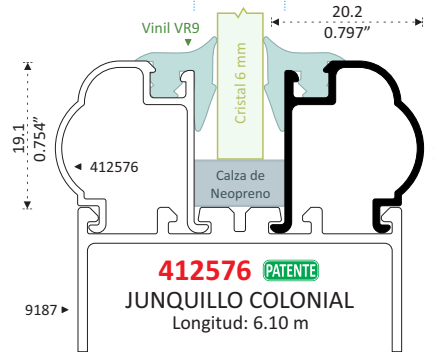
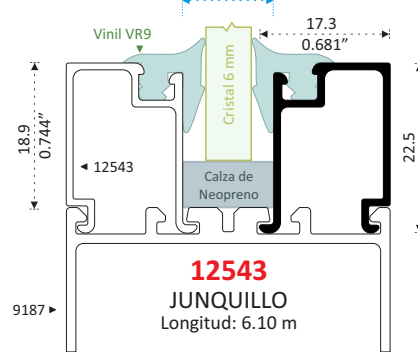
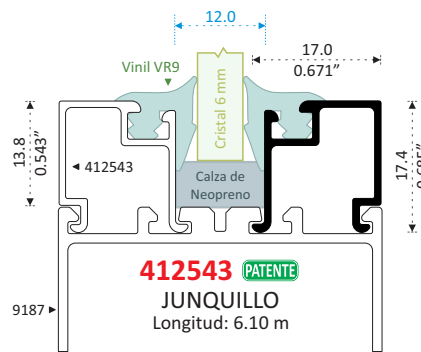

VINIL INTERIOR

VINIL V3 CRISTAL 9 mm Y DUELA 10 mm
CRISTAL 6 mm Y DUELA 6.5 mm VINIL V5

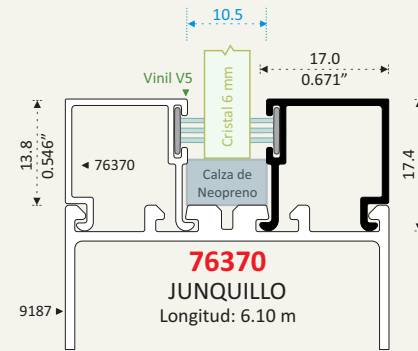
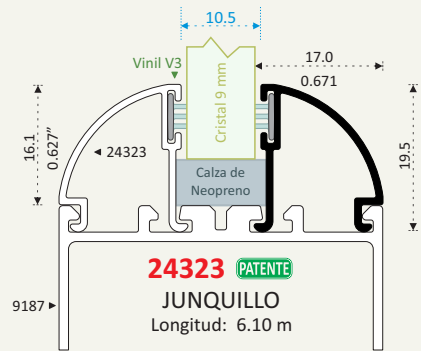

VINIL V4 CRISTAL 9 mm Y DUELA 10 mm (Junquillos 24325, 24326)

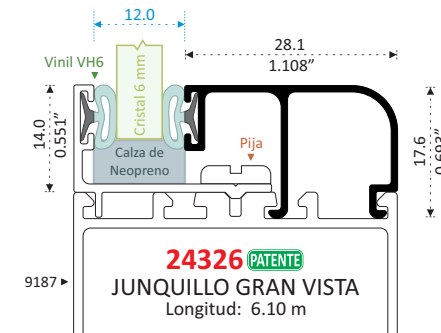
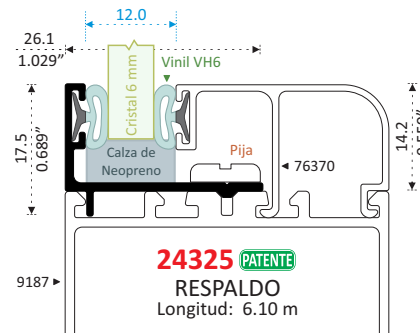

MARQUETERÍA

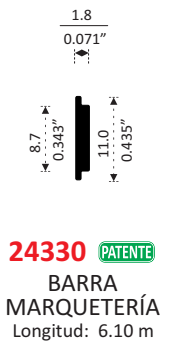
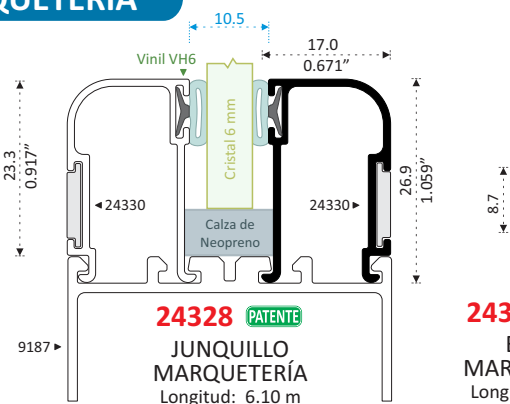
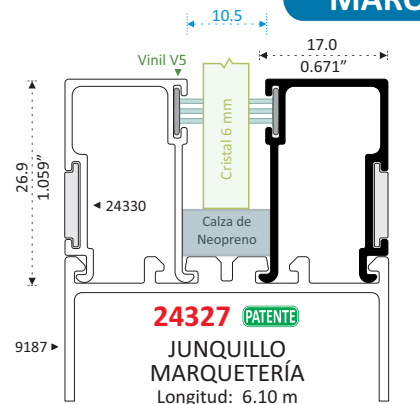
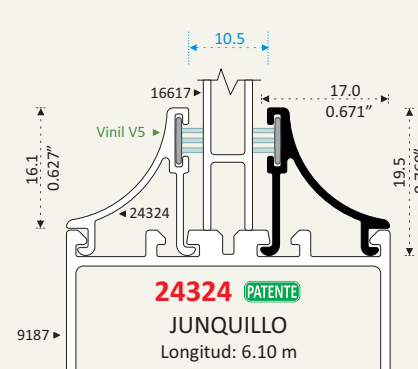
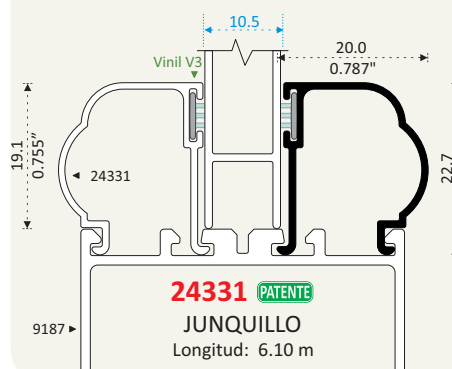

CRISTAL DOBLE

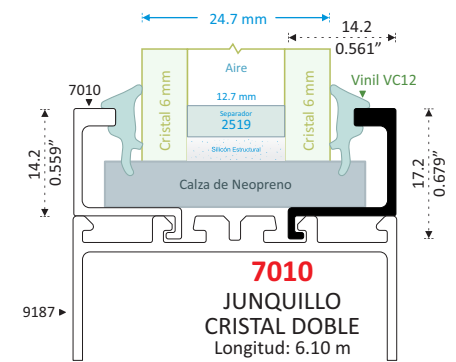
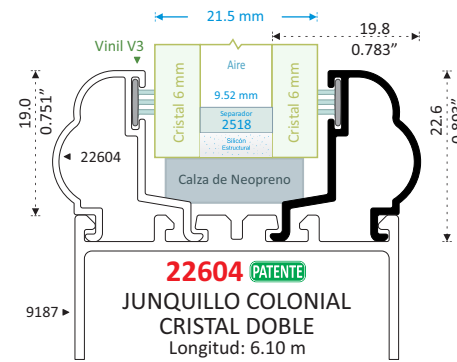
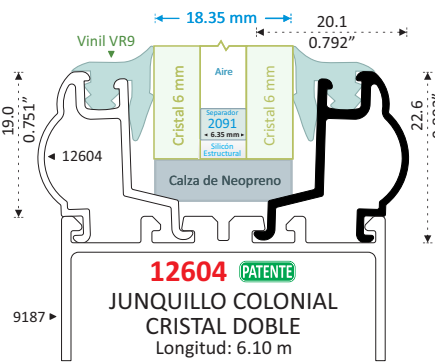
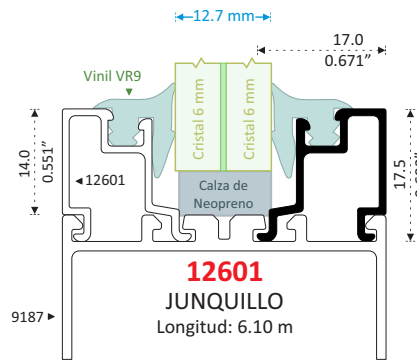

Alta Resistencia

- Al Impacto
- Entrada Forzada
- Fuertes Ráfagas de Vientos

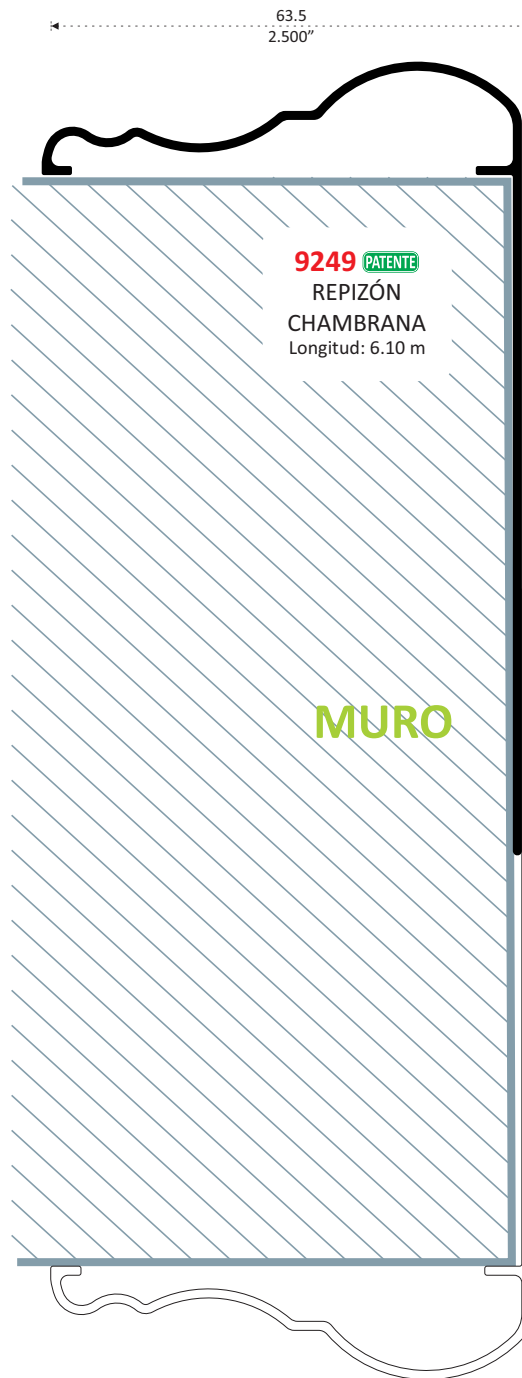
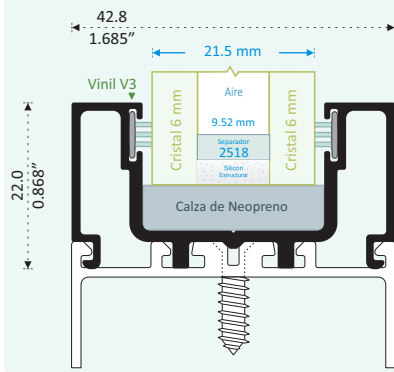
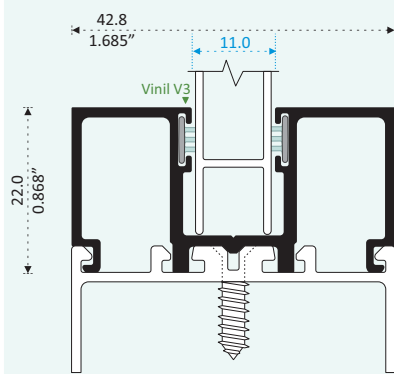
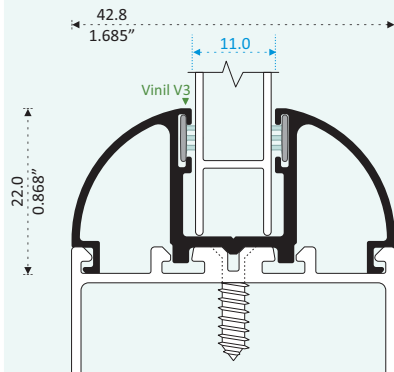
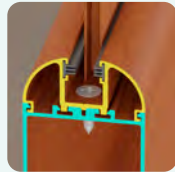

3 FELPAS

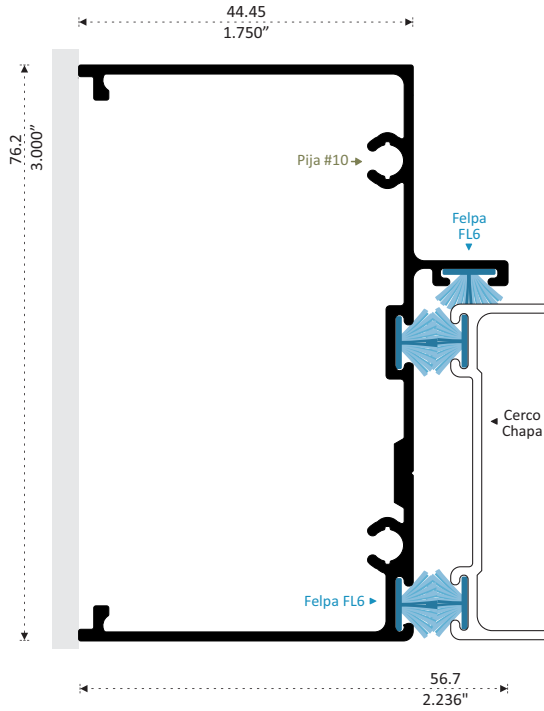

9132 PATENTE
BATIENTE
Longitud 6.10 m

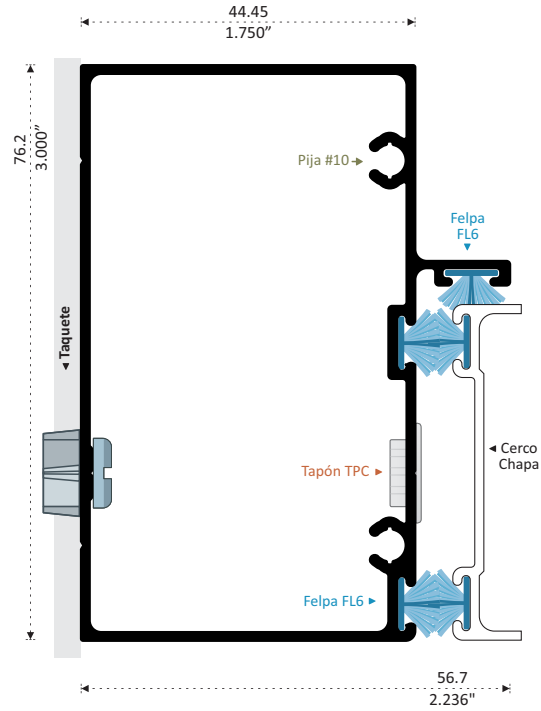

9134 PATENTE
BATIENTE
Longitud 6.10 m

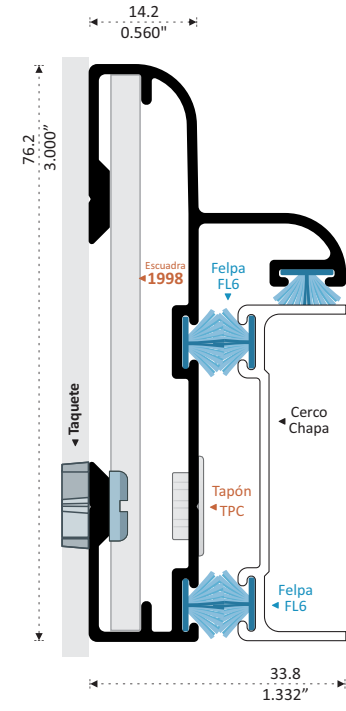

9244
BATIENTE COLONIAL
Longitud 6.10 m

1 FELPA

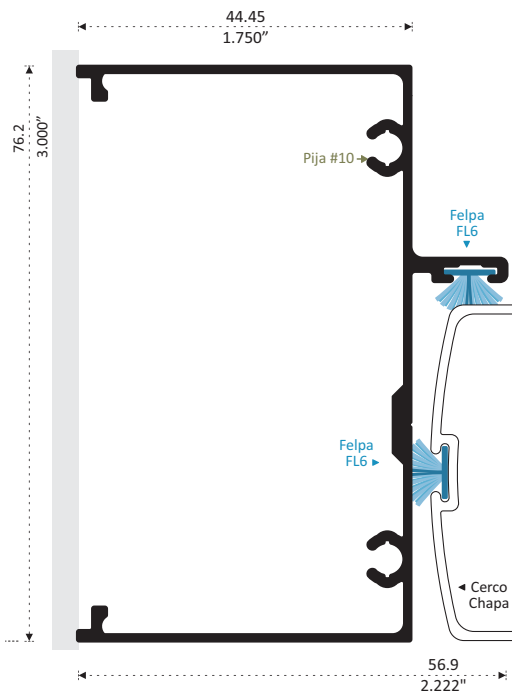

9116
BATIENTE
Longitud 6.10 m

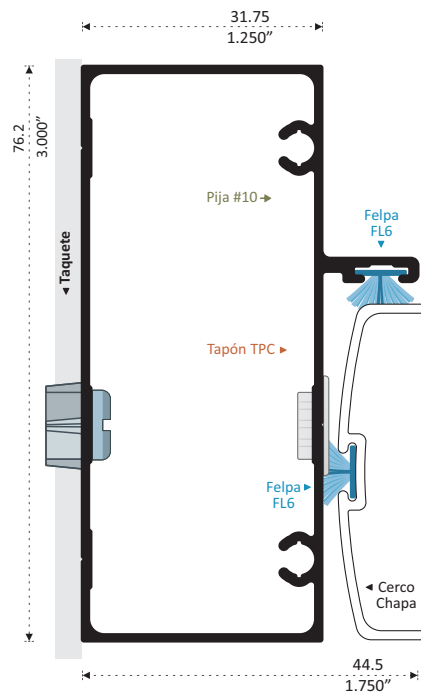

9133
BATIENTE
Longitud 6.10 m

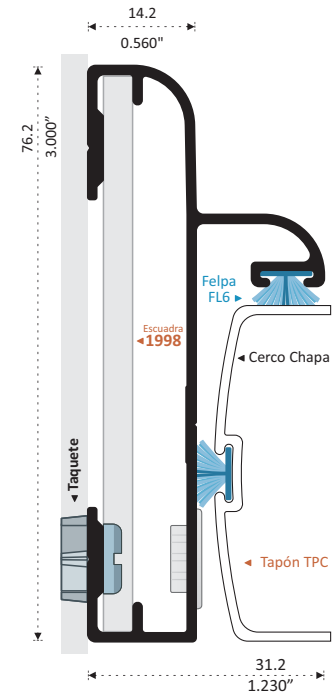

69244
BATIENTE COLONIAL
Longitud 6.10 m

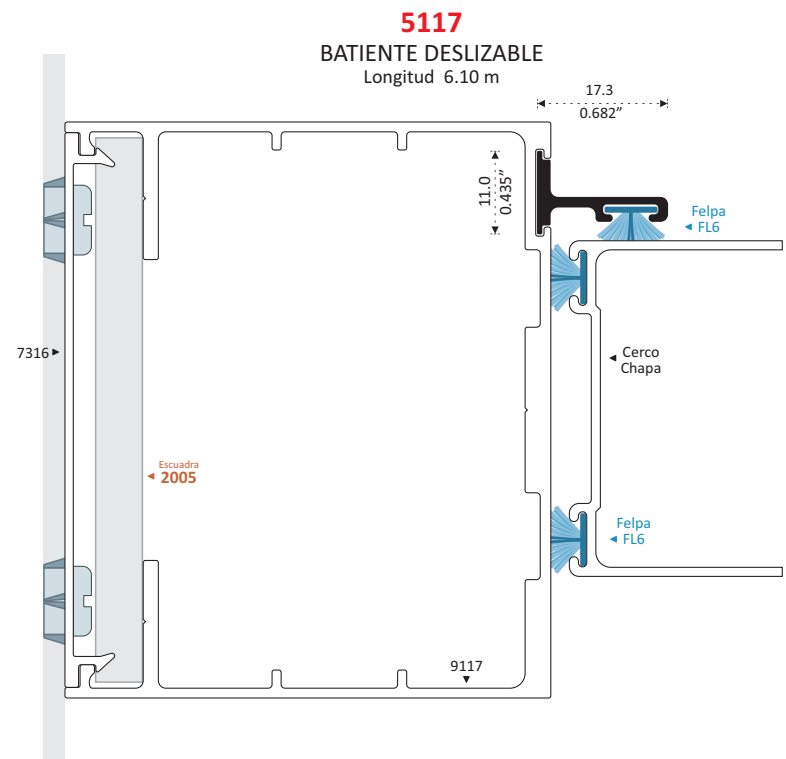
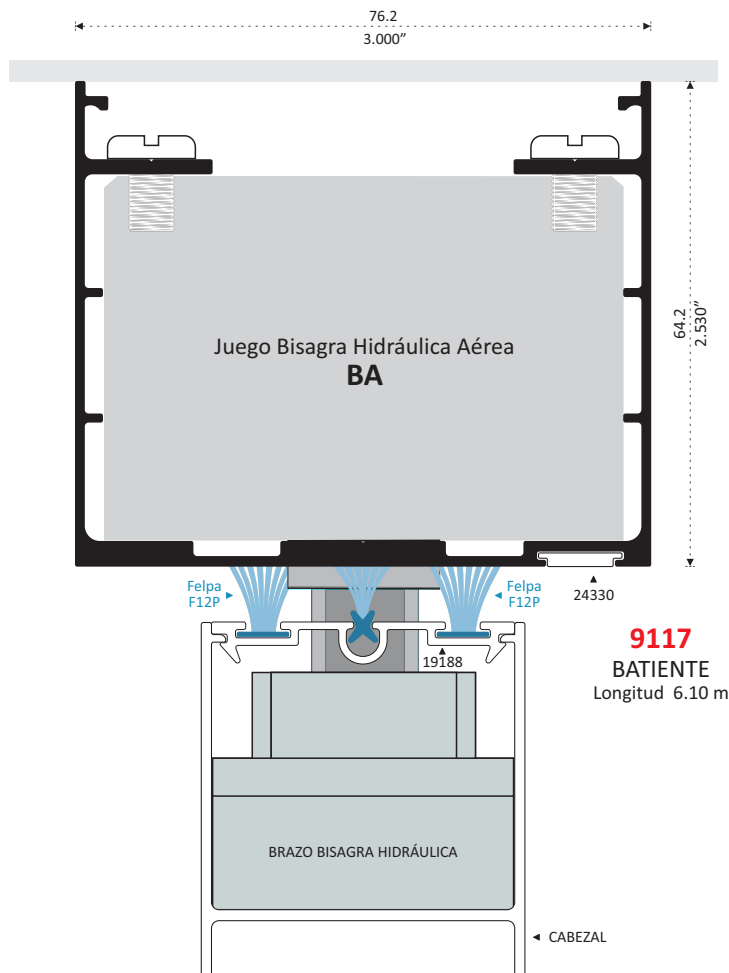
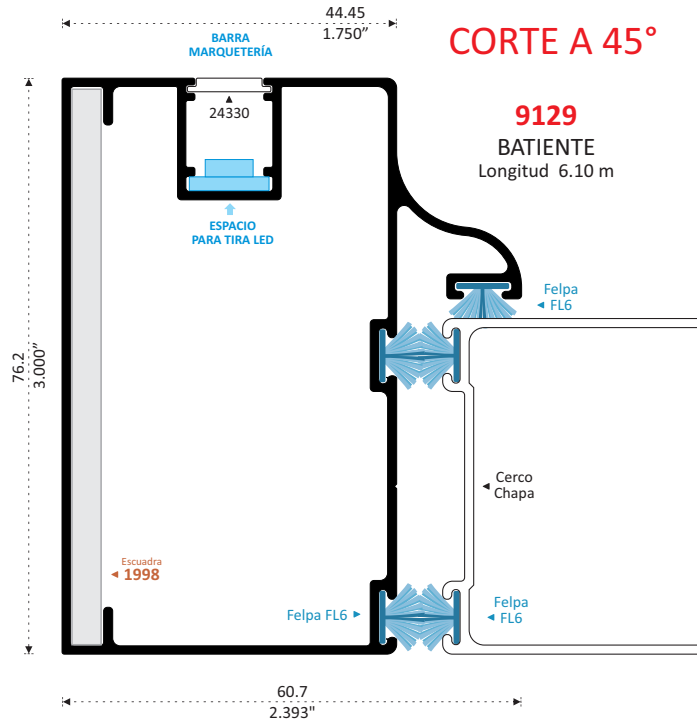



 **Perfiletto**[®]
ALUMINUM

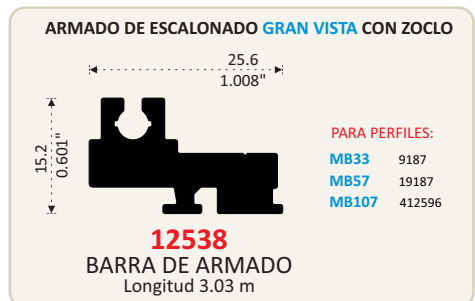
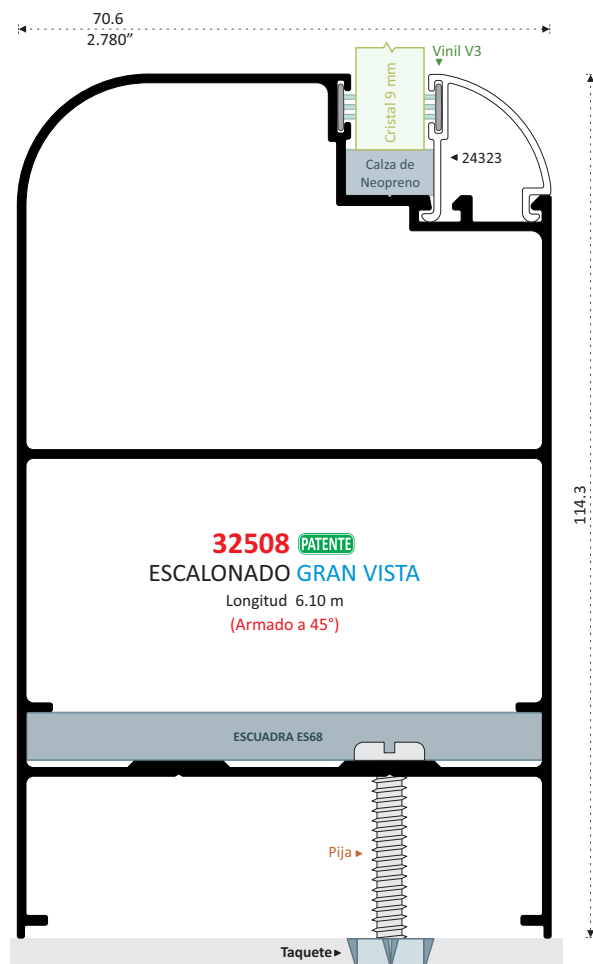
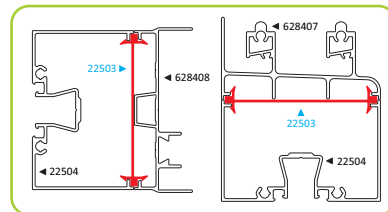
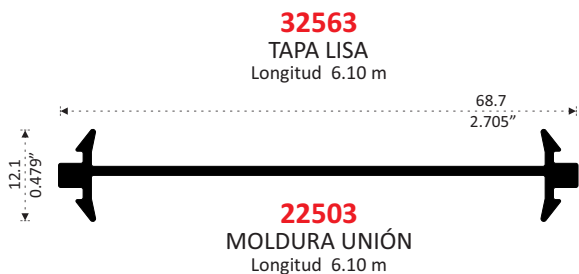
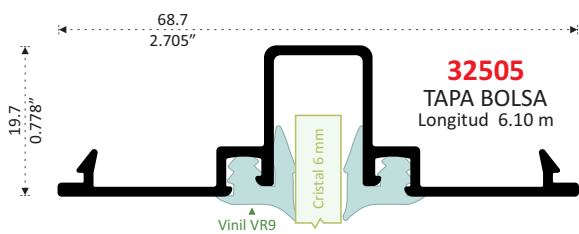
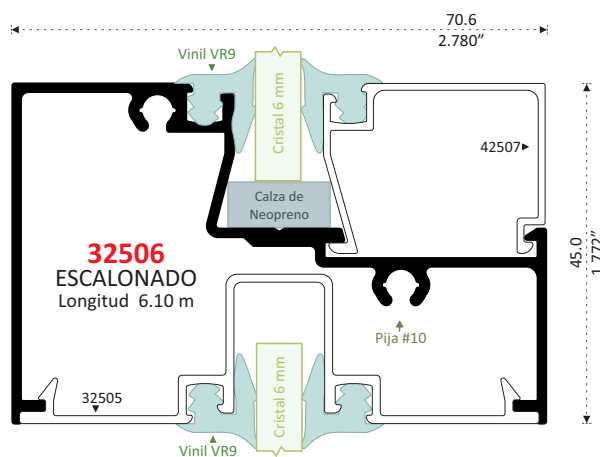
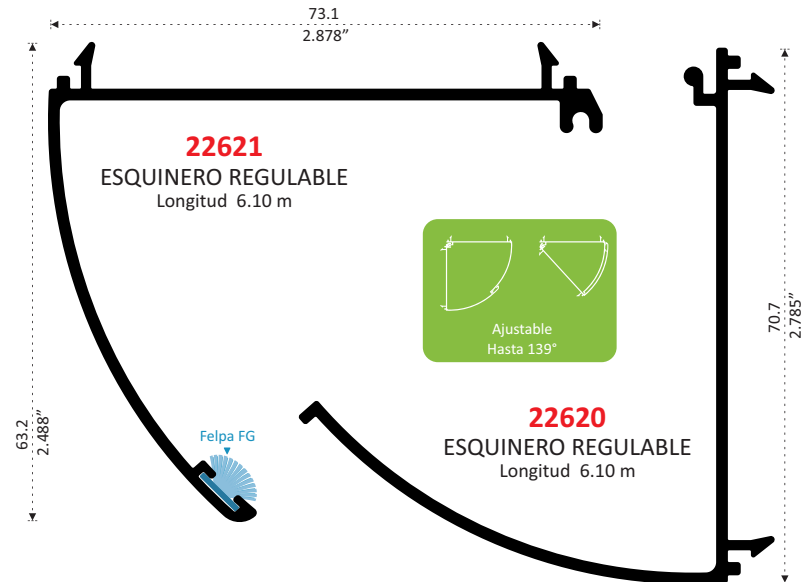
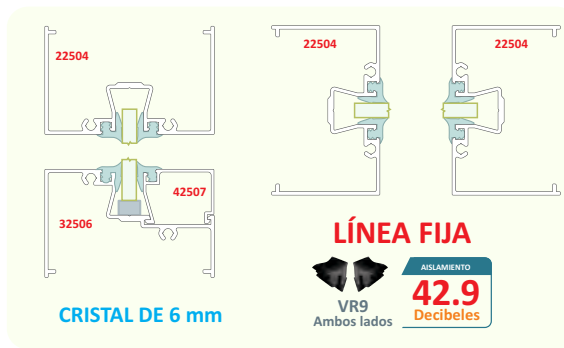
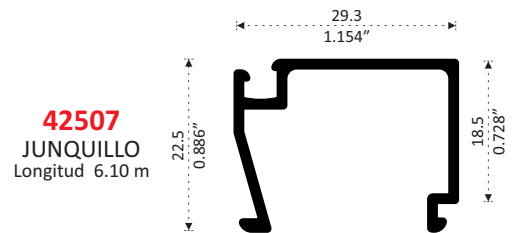
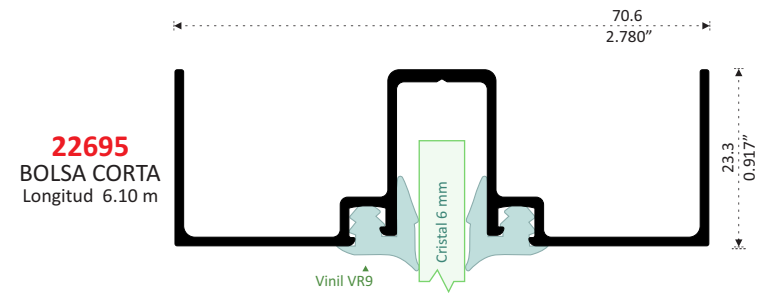
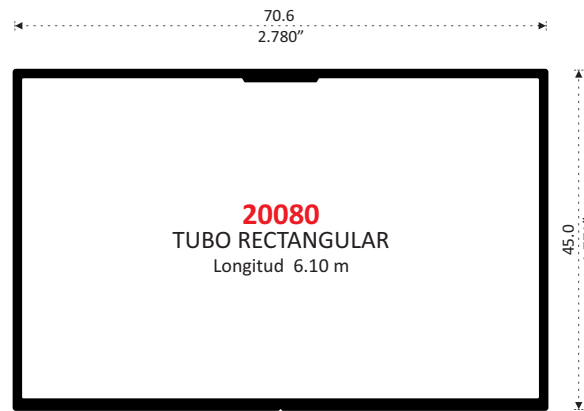
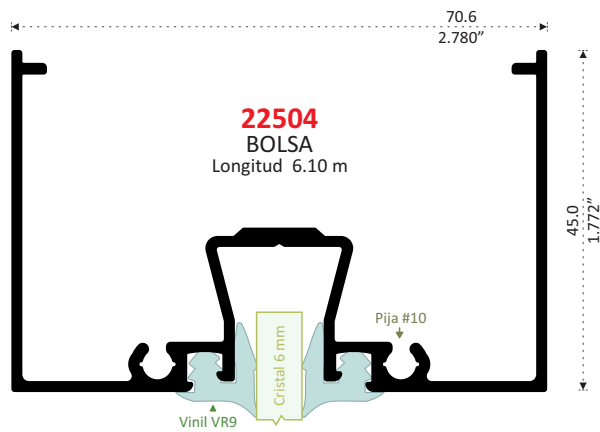

LÍNEA SERIE 70

Convierte un Producto Perfilto En Extraordinario



Opcional:
1 ó 2
Hojas Móviles



Mejor Salida de Agua por:
- Riel con Pared Interior Alta
- Inclinación de Riel
- Drenes Inferiores

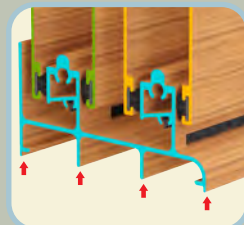

Resistencia de
con 4 Puntos de Apoyo
para Cristales Pesados



Mayor Hermeticidad
por Doble Felpa entre
Zoclo y Riel

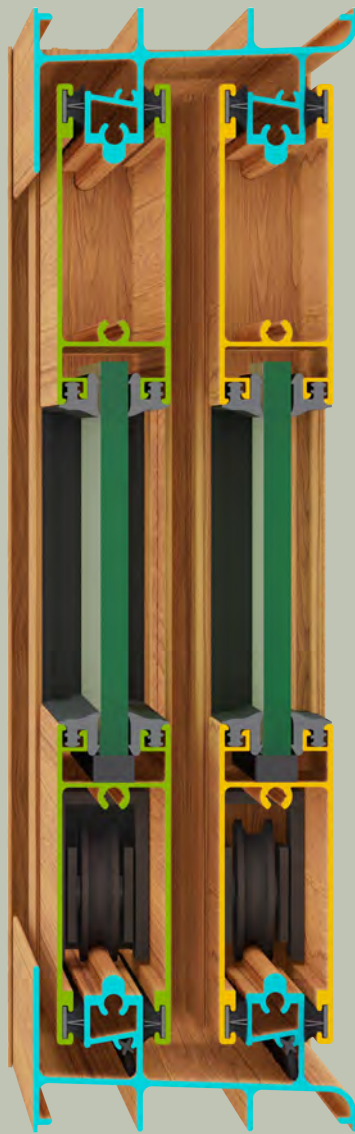

Mayor Hermeticidad por Rozamiento de Felpas FL6 con Labios Textiles



2 Felpas Horizontales
en Zoclo

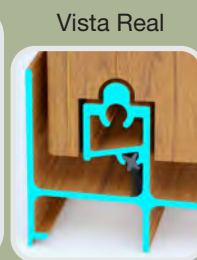

2 Felpas Verticales
en Traslapes

Vista Real

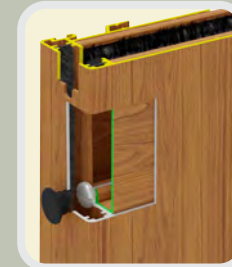

Zoclo Entra Hasta
el Fondo de
Cerco Chapa y Traslape



Jamba con Espacio para
Ocultar Pijas de Fijación
Colocar Tapón TPC

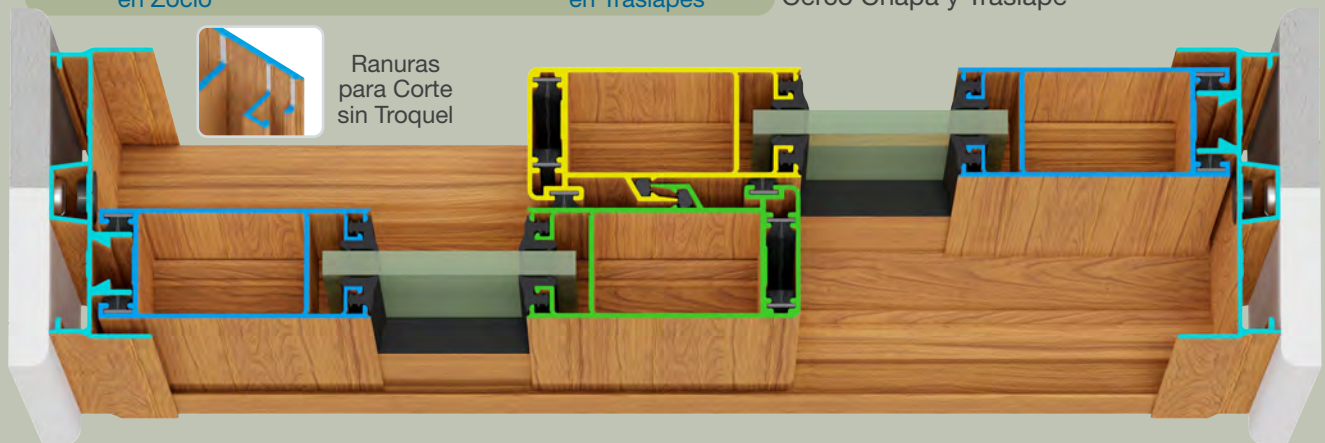

Ranuras
para Corte
sin Troquel



Mayor Firmeza
de
Vinilos Respaldo

Doble Vinil Respaldo
Aumenta
Aislamiento Acústico

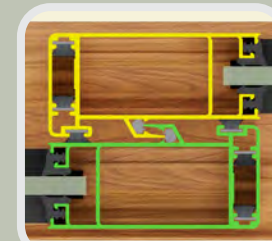

Hermeticidad entre
Traslapes por
2 Vinilos VPZP y 6 Felpas

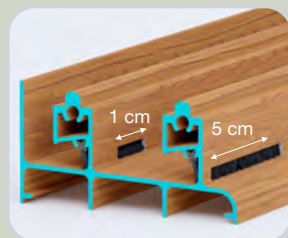

Aumentan la Hermeticidad:
- Aislamiento Acústico
- Resistencia a Viento
- Filtra Polvo
- Salida de Agua
- Impide Entrada de Insectos

Riel Inferior
Incluye Drenes cada 40 cm
Colocar Felpa F11P

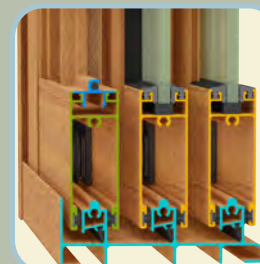

Mosquetero
Corredizo Interior
Riel Triple

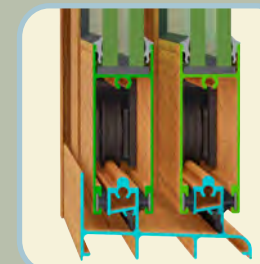

Doble Cristal de 6 mm
con Separador de 3/16"
Vinil en Ambos Lados

Instale las hojas
que Requiera

Riel Superior

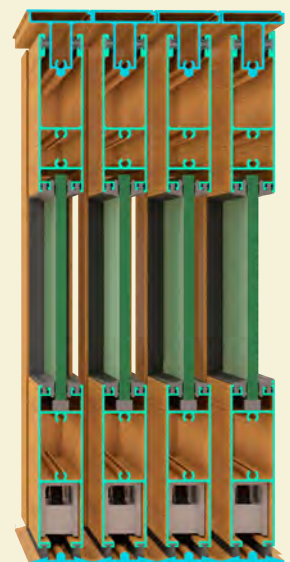

Riel Sencillo a Piso

■ Aislamiento Acústico Ventana 39.0 Decibles
Puerta 40.1 Decibles

■ Permeabilidad a Viento y Polvo Ventana Aire que Detiene 91 %
Puerta Aire que Detiene 93 %

■ Resistencia A Vientos Sin Deformar el Perfil Ventana 120 Km/h
Puerta 120 Km/h

ASLAMIENTO ACÚSTICO
REALIZADO CON 120 DECIBELAS AL EXTERIOR
MEDIDA 1.00 x 1.00 m

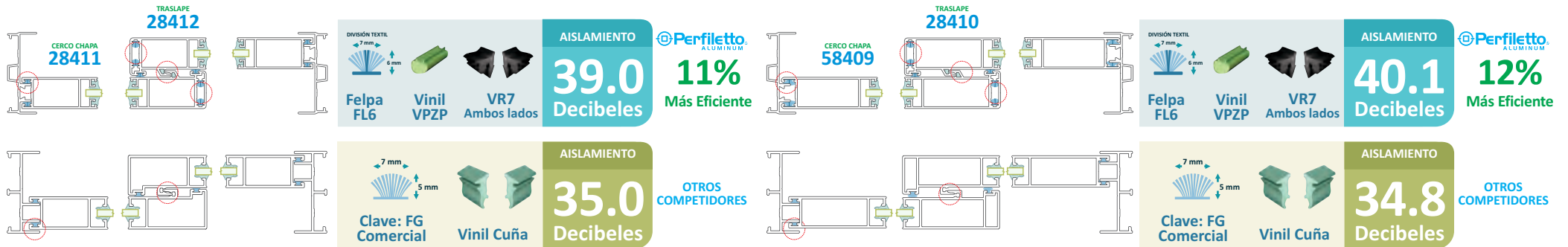

PERMEABILIDAD AL AGUA DURANTE 20 MINUTOS

VENTANA MEDIDA 1.00 x 1.00 m			MOSQUITERO CORREDIZO EXTERIOR 11408, 18413 y 11411			
VELOCIDAD KM/H	Agua	Aire	SIN MOSQUITERO		MOSQUITERO CORREDIZO INTERIOR 11408, 18413 y 11411	
20	50%	50%	Sin Filtraciones		Sin Filtraciones	
40	50%	50%				
60	50%	50%				
80	50%	50%				
100	50%	50%				
120	60%	40%				

PUERTA MEDIDA 1.00 x 1.00 m			MOSQUITERO CORREDIZO EXTERIOR 11408, 18413 y 11411			
VELOCIDAD KM/H	Agua	Aire	SIN MOSQUITERO		MOSQUITERO CORREDIZO INTERIOR 11408, 18413 y 11411	
20	50%	50%	Sin Filtraciones		Sin Filtraciones	
40	50%	50%				
60	50%	50%				
80	50%	50%				
100	50%	50%				
120	60%	40%				

MOSQUITERO CORREDIZO EXTERIOR OCASIONA ALTA FILTRACIÓN DE AGUA

MOSQUITERO CORREDIZO EXTERIOR OCASIONA ALTA FILTRACIÓN DE AGUA

PERMEABILIDAD AL VIENTO Medida 1.00 x 1.00 m

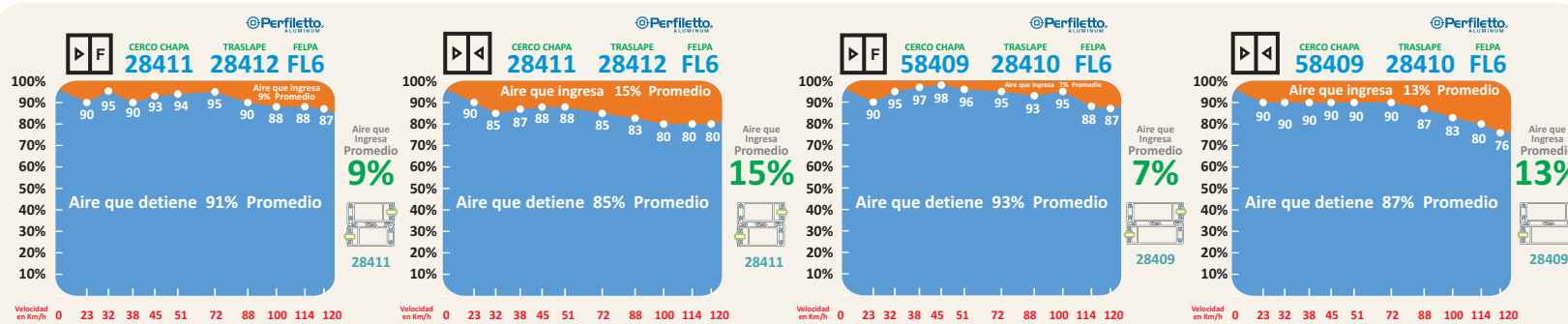

RESISTENCIAS A VIENTOS

VENTANA
Prueba Realizada 30 Repeticiones de 1 Minuto c/u A 120 Km/h
Medida 1.00 x 1.00 m
Cristal 6 mm
LOS PERFILES SIN DEFORMACIÓN CONSERVAN SU FUNCIONAMIENTO

PUERTA
Prueba Realizada 30 Repeticiones de 1 Minuto c/u A 120 Km/h
Medida 2.00 X 2.10 m
Cristal 6 mm
LOS PERFILES SIN DEFORMACIÓN CONSERVAN SU FUNCIONAMIENTO

COMPETIDOR

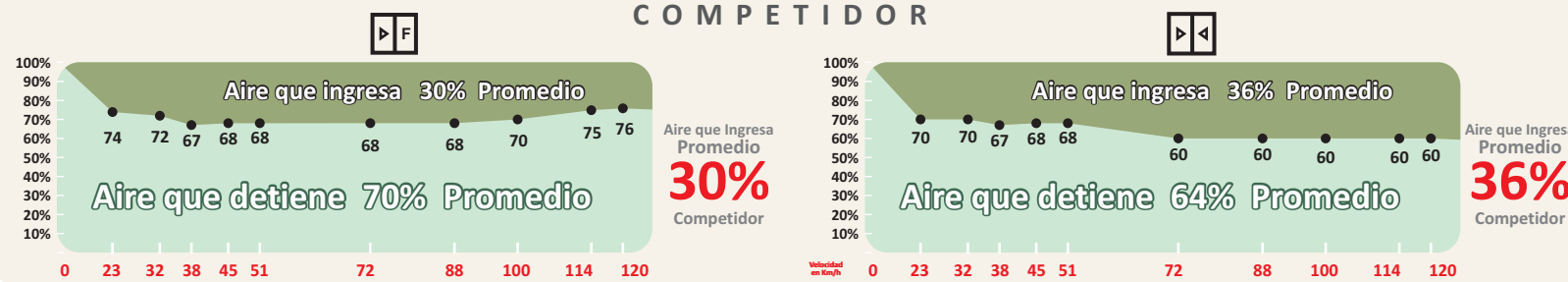

22547 PATENTE
ZOCLO Y CABEZAL
Longitud 6.10 m

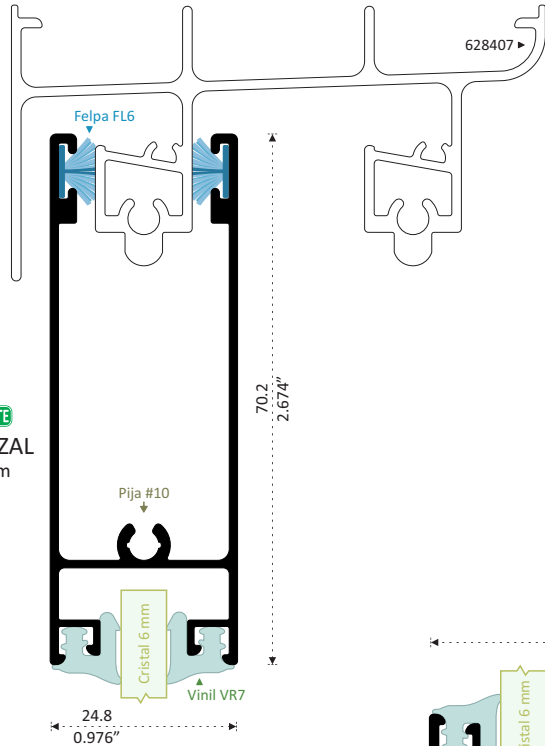

68411
INTERMEDIO
Longitud 6.10 m

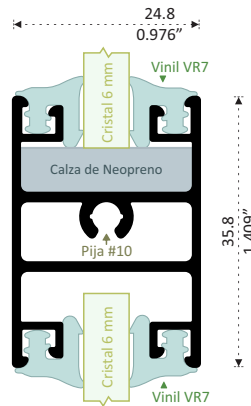
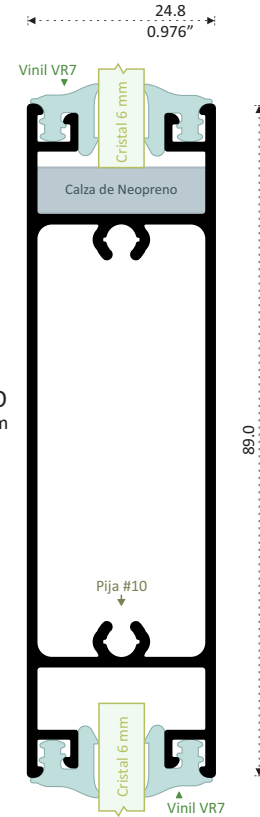

13842 PATENTE
INTERMEDIO
Longitud 6.10 m

Carretilla S412

22263 PATENTE
ZOCLO
Longitud 6.10 m

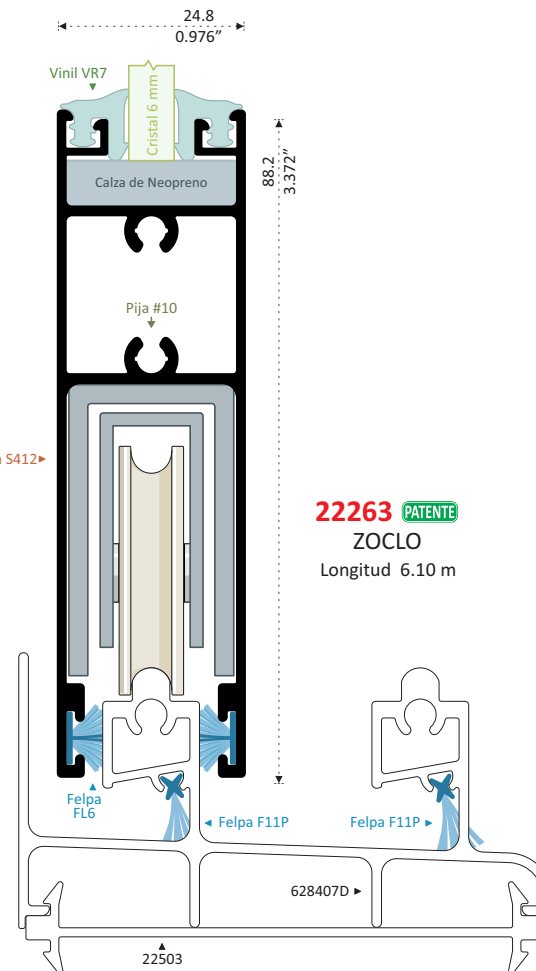

Mayor Resistencia a la entrada de Agua

628407
RIEL Y CABEZAL
Longitud 6.10 m
628407-C 3.05 m

628407D
Longitud 6.10 m

628407D-C
Longitud 3.05 m

Drenes cada 40 cm sin Costo

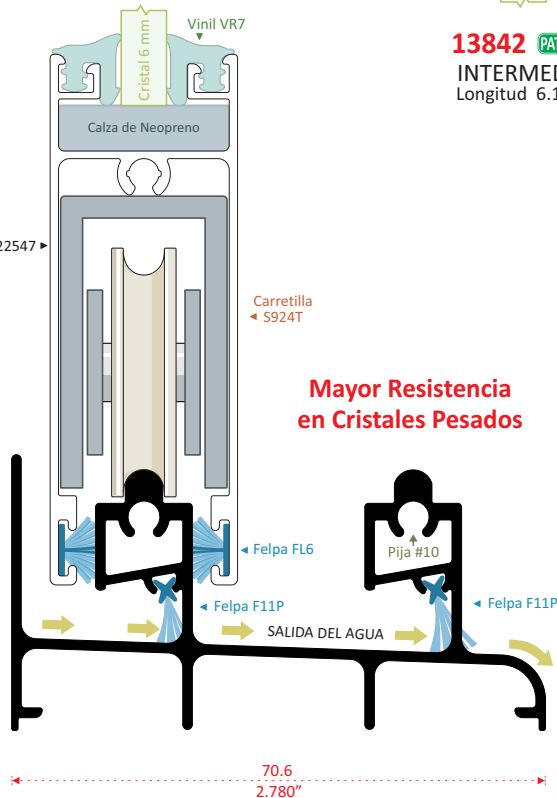

Mayor Resistencia en Cristales Pesados

MAYOR VISTA Y VINILOS OCULTOS

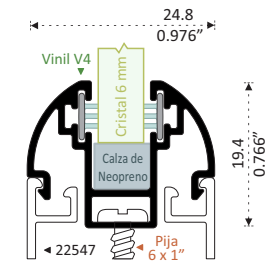

8268 PATENTE
ADAPTADOR CURVO
Longitud 6.10 m

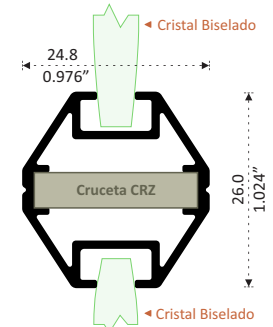
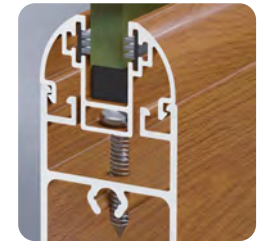

8267 PATENTE
INTERMEDIO BISELADO
Longitud 6.10 m

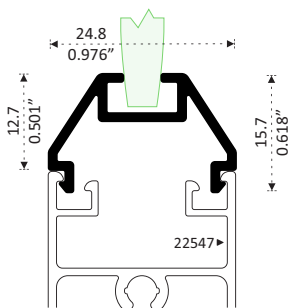

8266 PATENTE
RETÍCULA PERIMETRAL
Longitud 6.10 m

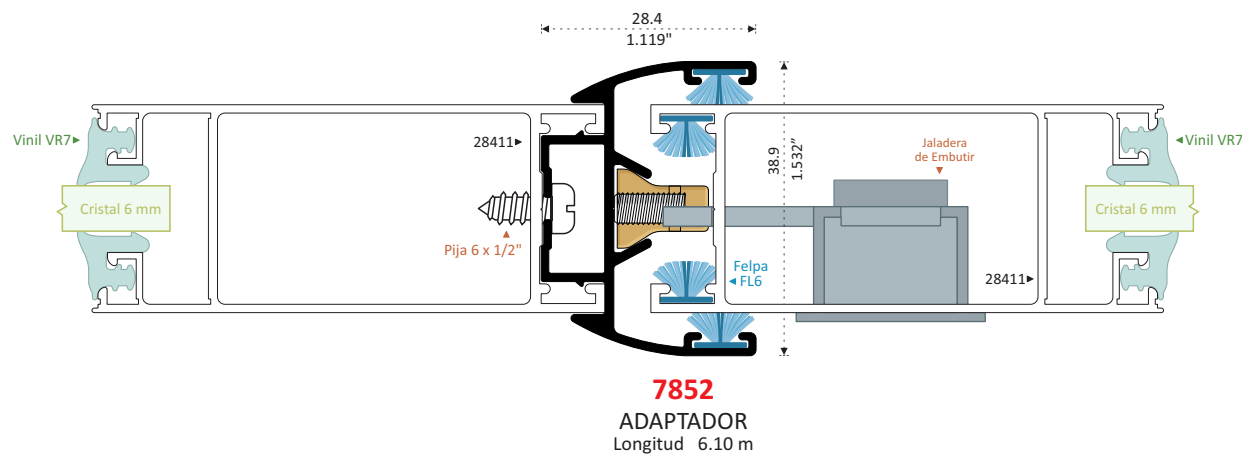
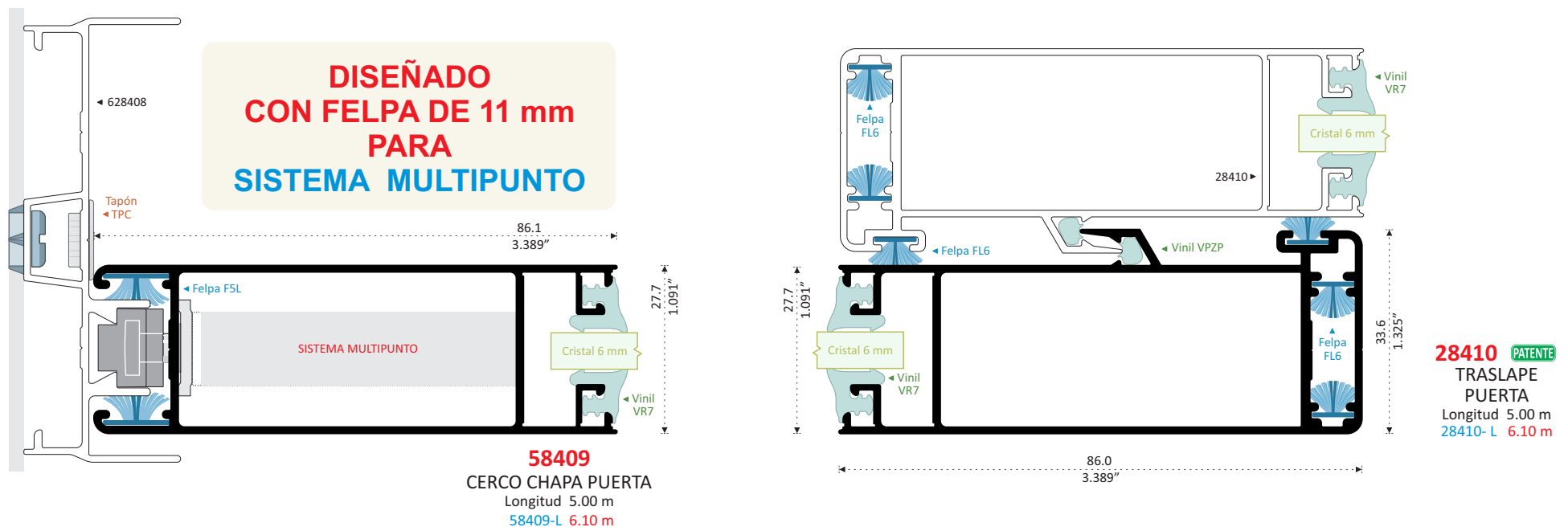
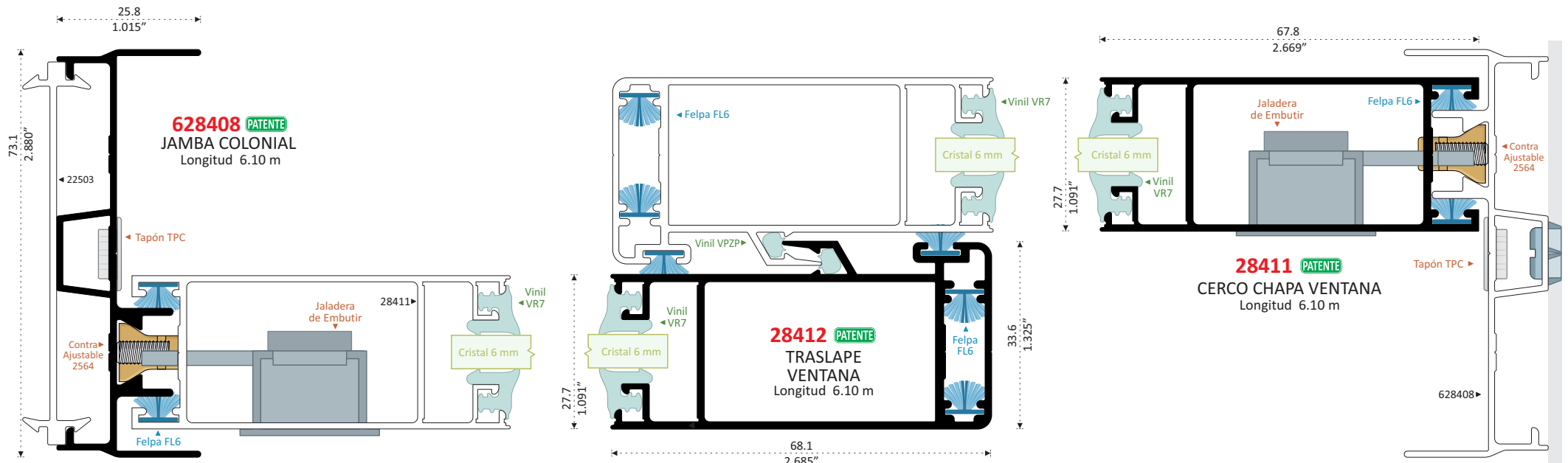

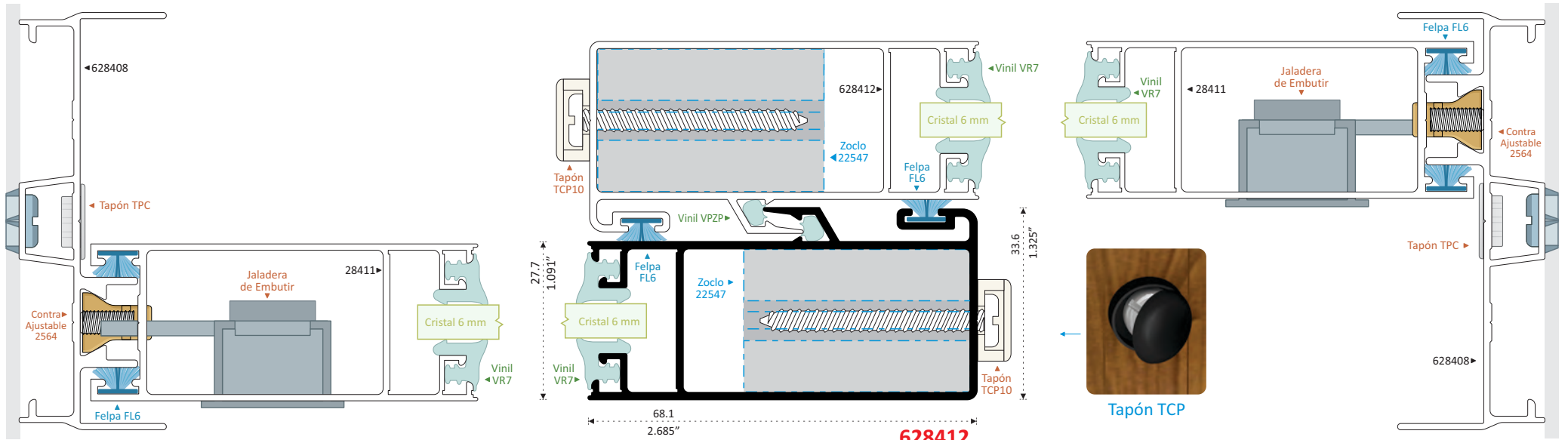

628412
TRASLAPE VENTANA
Longitud 6.10 m

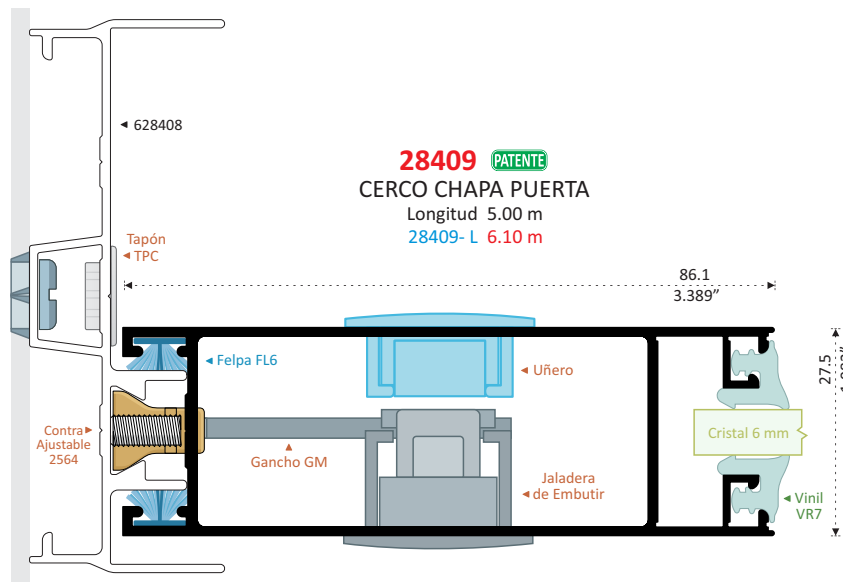

28409 PATENTE
CERCO CHAPA PUERTA
Longitud 5.00 m
28409-L 6.10 m

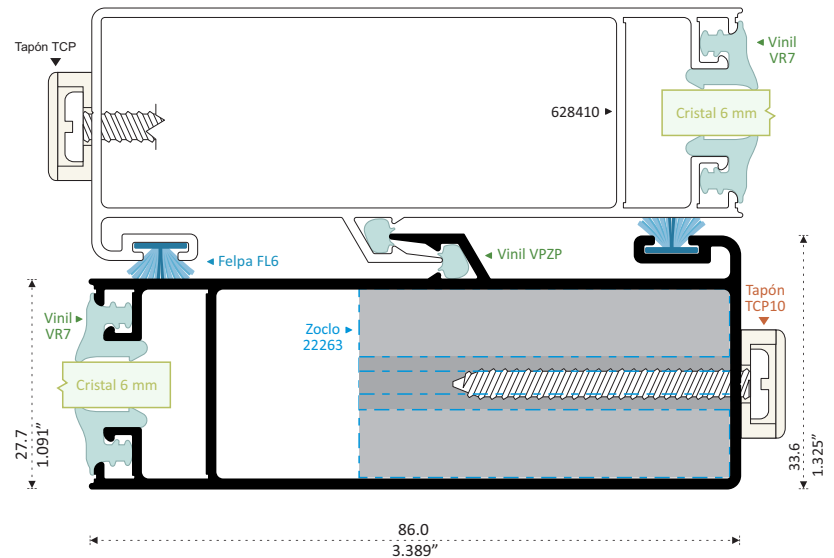

628410
TRASLAPE PUERTA
Longitud 5.00 m



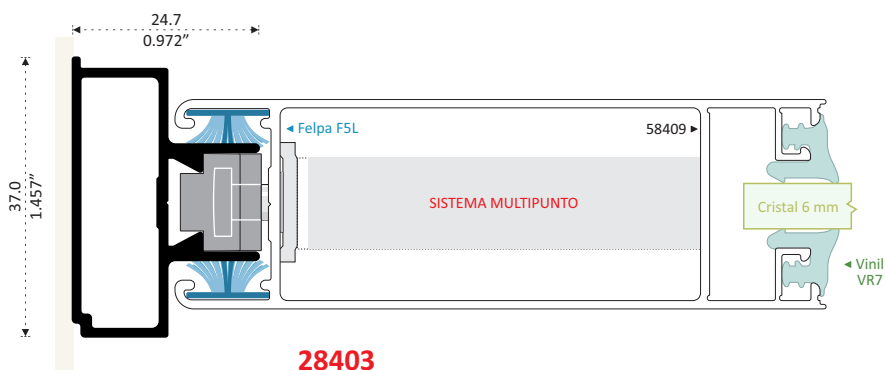
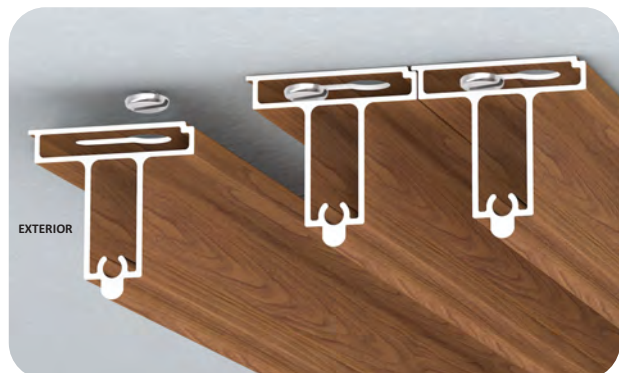

28403
JAMBA SENCILLA
Longitud 6.10 m



28401
RIEL SENCILLO
Longitud 6.10 m

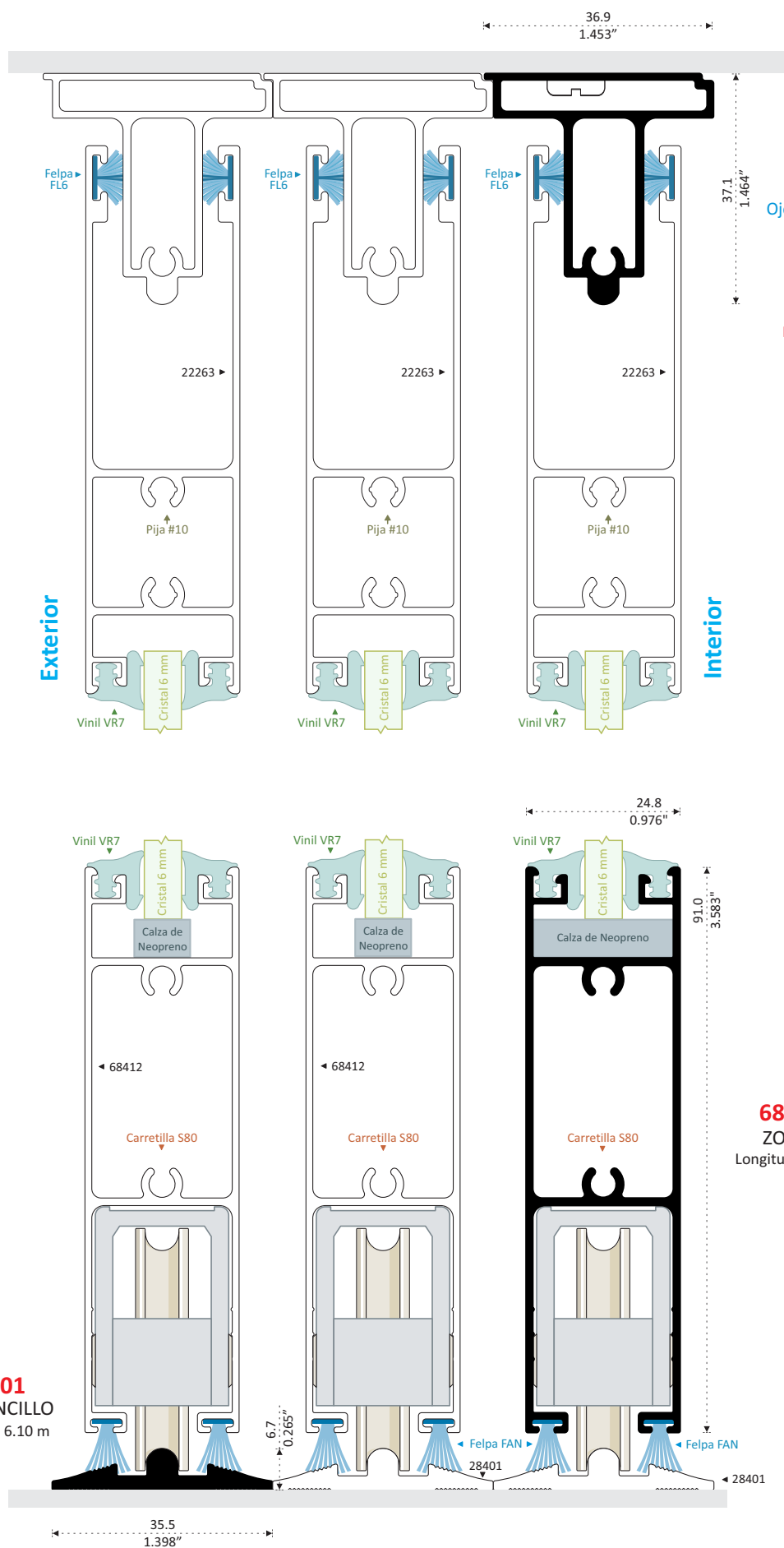

28402
RIEL SUPERIOR
Longitud 6.10 m
Ojos de Llave cada 40 cm
sin Costo

Por su Altura
Absorbe 15 mm
en
Movimientos de Losa.

68412
ZOCLO
Longitud 6.10 m

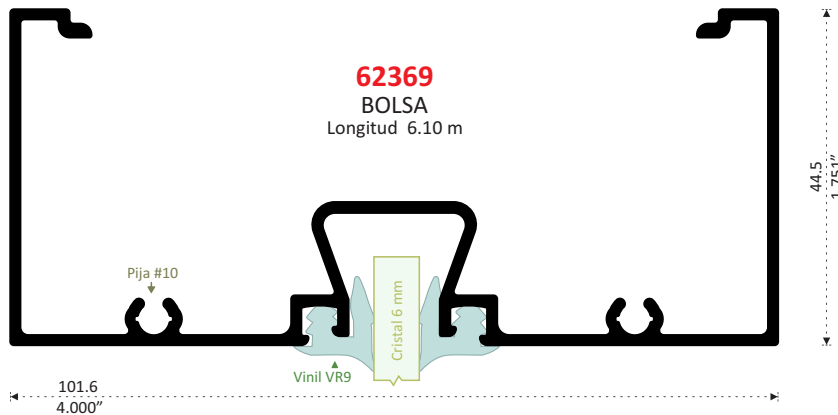
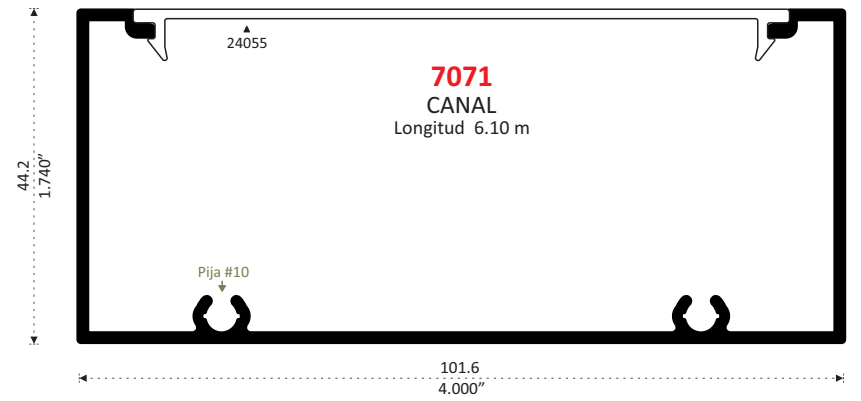
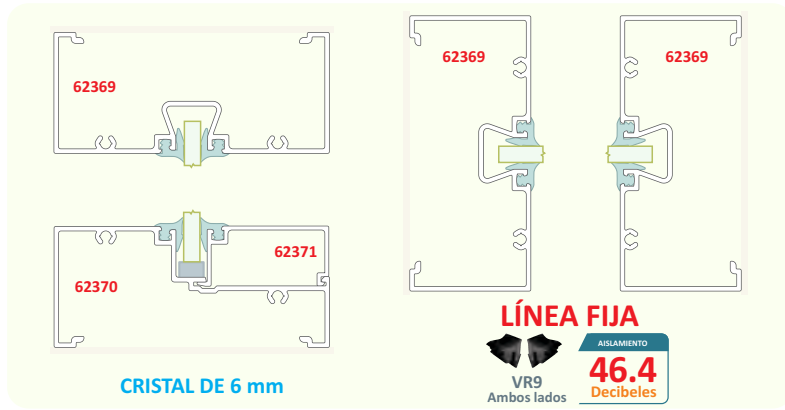

LÍNEA DISEÑADA PARA VINIL RESPALDO

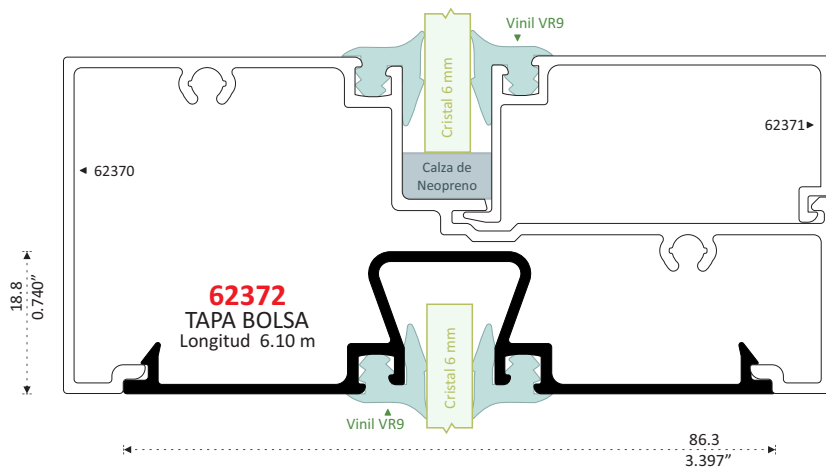
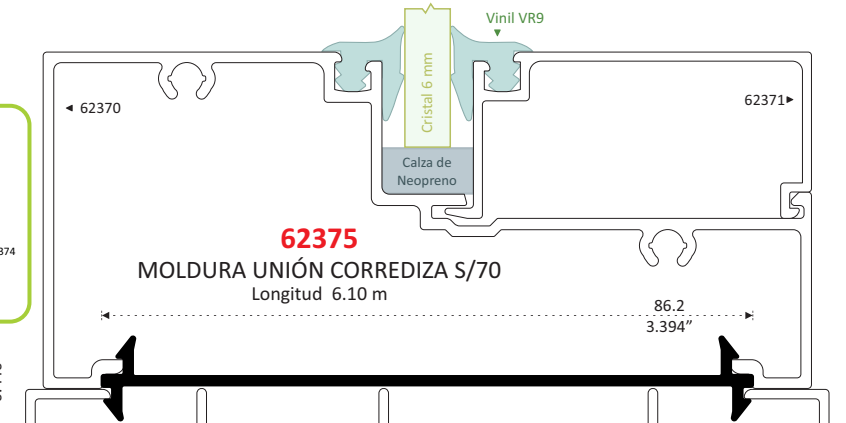
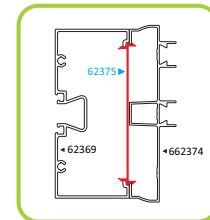
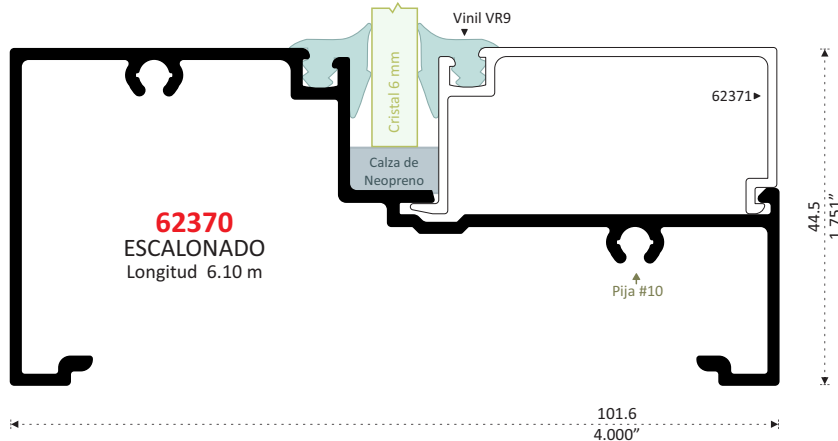
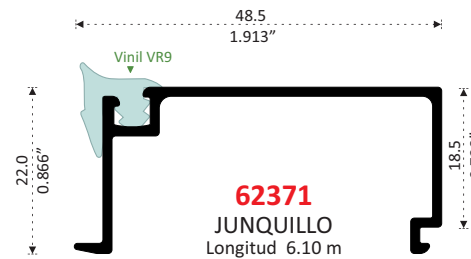

Utilizar 62372 como Soporte del Escalonado en Cristales Pesados

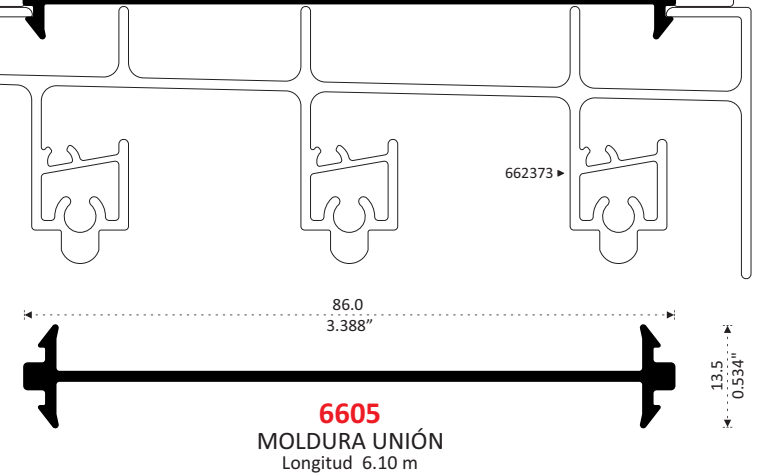
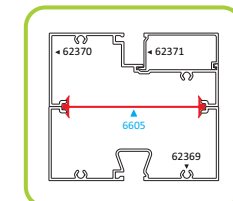

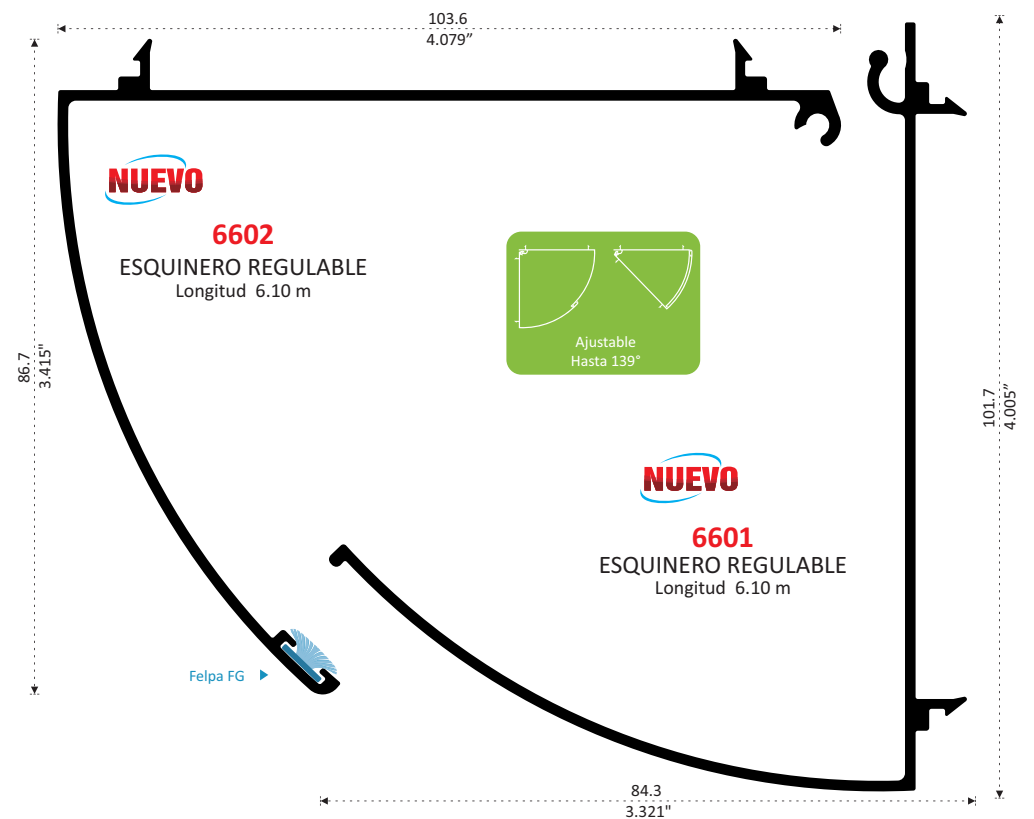
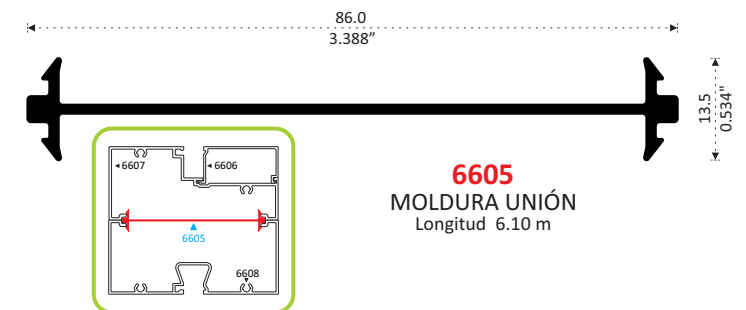
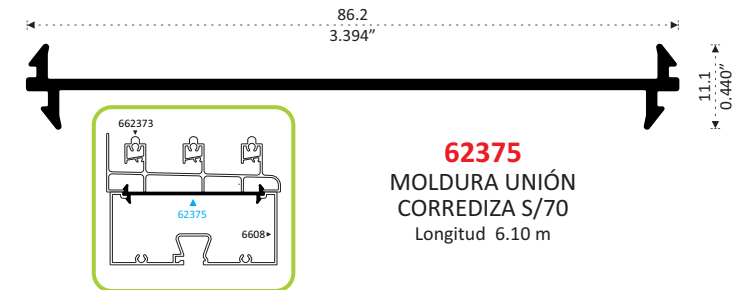
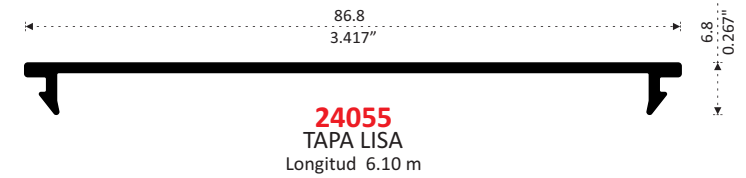
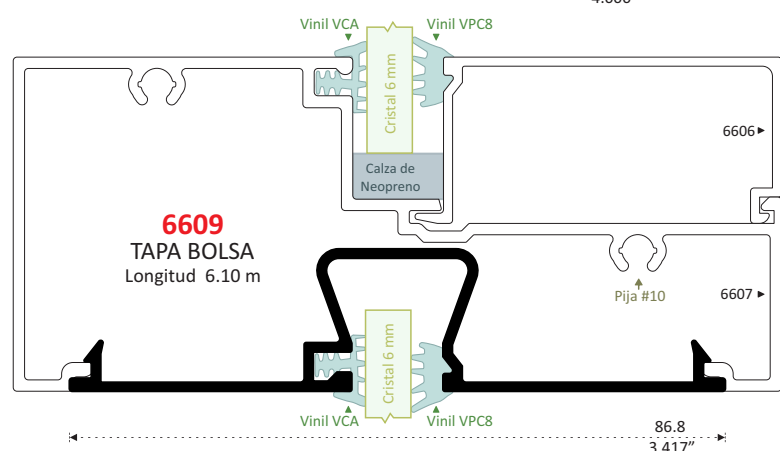
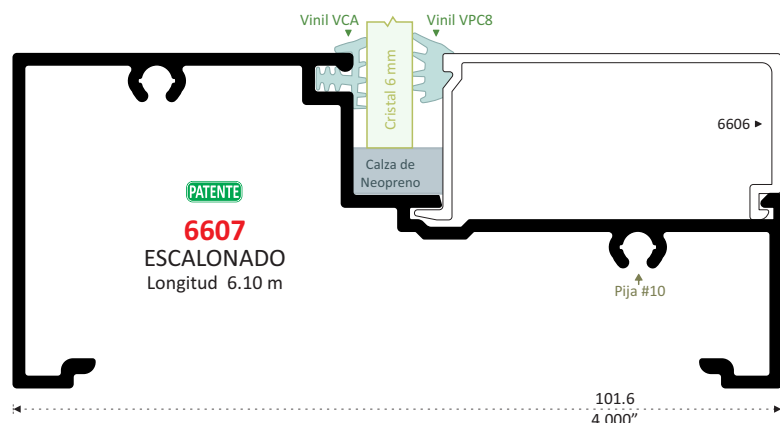
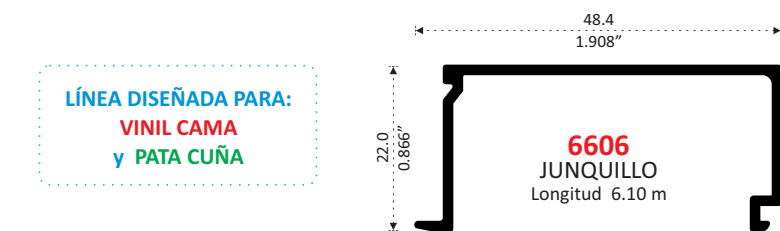
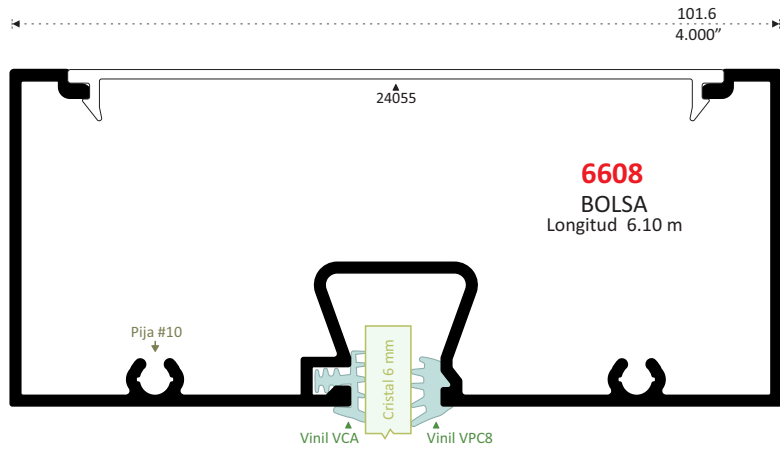
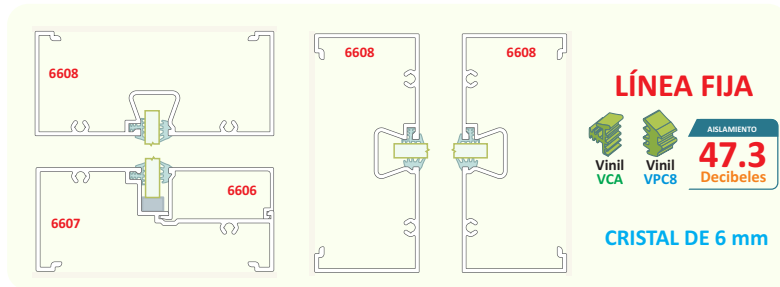

Utilizar 6609
como Soporte
del Escalonado en
Cristales Pesados

CORREDIZA SERIE 70 TRIPLE

PRUEBAS EN NUESTRO CENTRO DE INVESTIGACIÓN Y DESARROLLO Armadas con Perfiles y Complementos Esenciales 100% Perfiletto

AI SLAM IENTO ACÚSTICO REALIZADO CON 120 DECIBELES AL EXTERIOR MEDIDA 1.00 x 1.00 m



AI SLAM IENTO
37.0
Decibeles



PERMEABILIDAD AL AGUA DURANTE 20 MINUTOS

VENTANA MEDIDA 1.00 x 1.00 m

VELOCIDAD KM/H	Agua	Aire
20	50%	50%
40	50%	50%
60	50%	50%
80	50%	50%
100	50%	50%
120	60%	40%

SIN MOSQUITERO
Sin Filtraciones

MOSQUITERO CORREDIZO INTERIOR
Sin Filtraciones

MOSQUITERO CORREDIZO EXTERIOR

VELOCIDAD KM/H	Agua	Aire	Litros Filtrados
20	50%	50%	6.75
40	50%	50%	8.87
60	50%	50%	10.50
80	50%	50%	11.23
100	50%	50%	12.25
120	60%	40%	13.00

MOSQUITERO CORREDIZO EXTERIOR
OCASIONA ALTA FILTRACIÓN DE AGUA

PUERTA MEDIDA 1.00 x 1.00 m

VELOCIDAD KM/H	Agua	Aire
20	50%	50%
40	50%	50%
60	50%	50%
80	50%	50%
100	50%	50%
120	60%	40%

SIN MOSQUITERO
Sin Filtraciones

MOSQUITERO CORREDIZO INTERIOR
Sin Filtraciones

MOSQUITERO CORREDIZO EXTERIOR

VELOCIDAD KM/H	Agua	Aire	Litros Filtrados
20	50%	50%	7.00
40	50%	50%	9.00
60	50%	50%	11.00
80	50%	50%	11.86
100	50%	50%	12.49
120	60%	40%	13.30

MOSQUITERO CORREDIZO EXTERIOR
OCASIONA ALTA FILTRACIÓN DE AGUA

PERMEABILIDAD AL VIENTO Medida 1.00 x 1.00 m

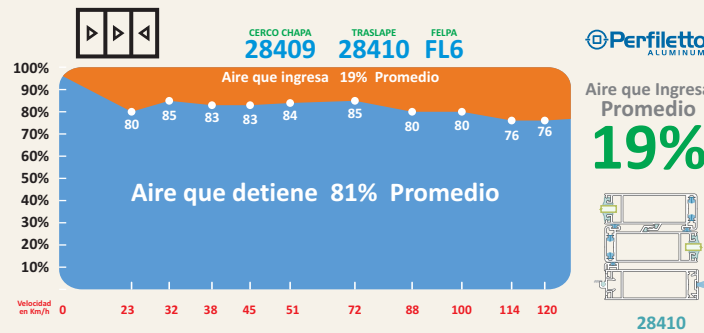
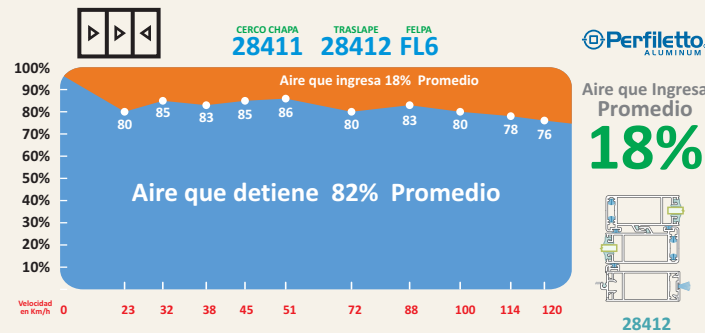

RESISTENCIAS A VIENTOS

VENTANA
Prueba Realizada
30 Repeticiones de 1 Minuto c/u
A 120 Km/h
Medida 1.00 x 1.00 m
Cristal 6 mm
LOS PERFILES SIN DEFORMACIÓN
CONSERVAN SU FUNCIONAMIENTO

PUERTA
Prueba Realizada
30 Repeticiones de 1 Minuto c/u
A 120 Km/h
Medida 2.00 X 2.10 m
Cristal 6 mm
LOS PERFILES SIN DEFORMACIÓN
CONSERVAN SU FUNCIONAMIENTO

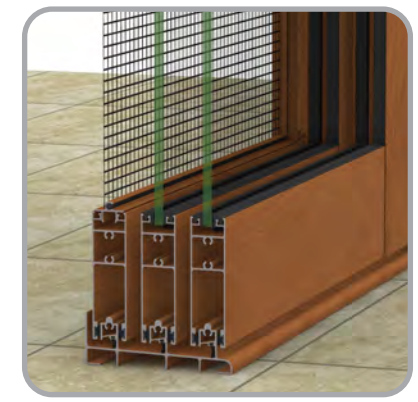
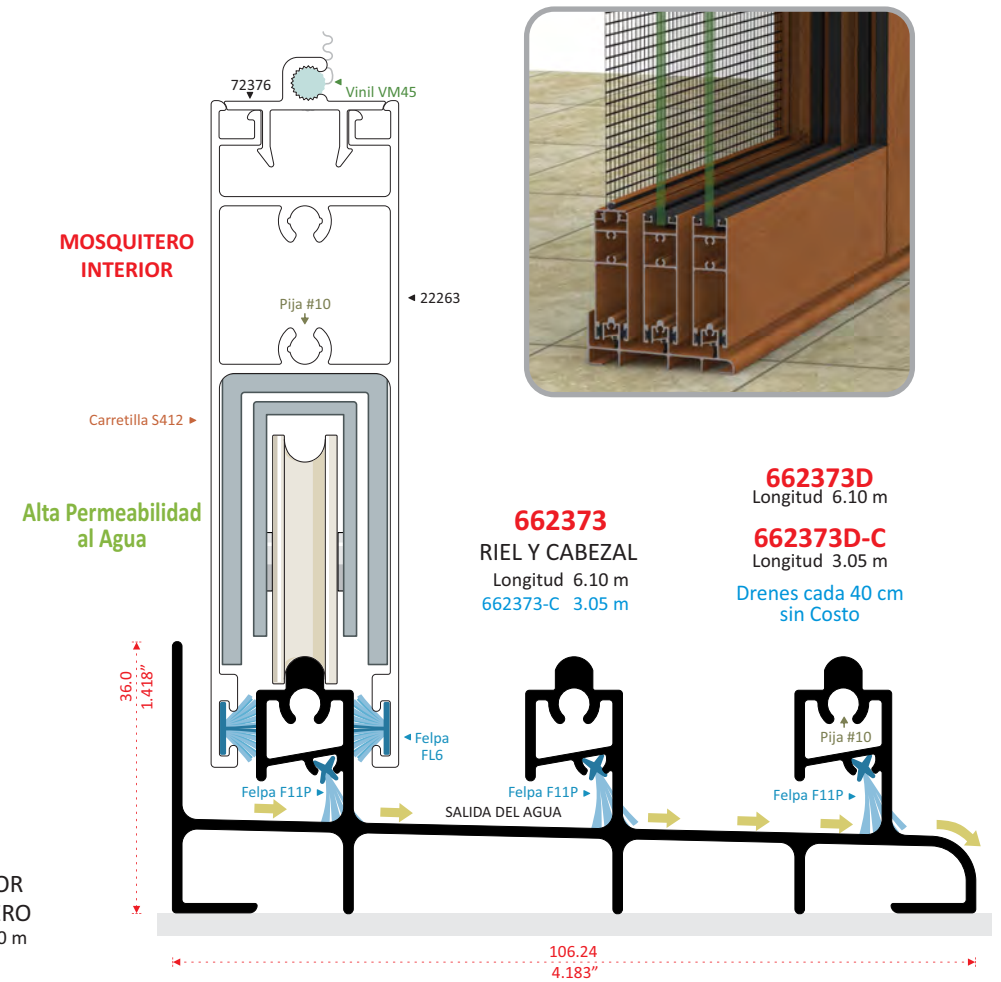
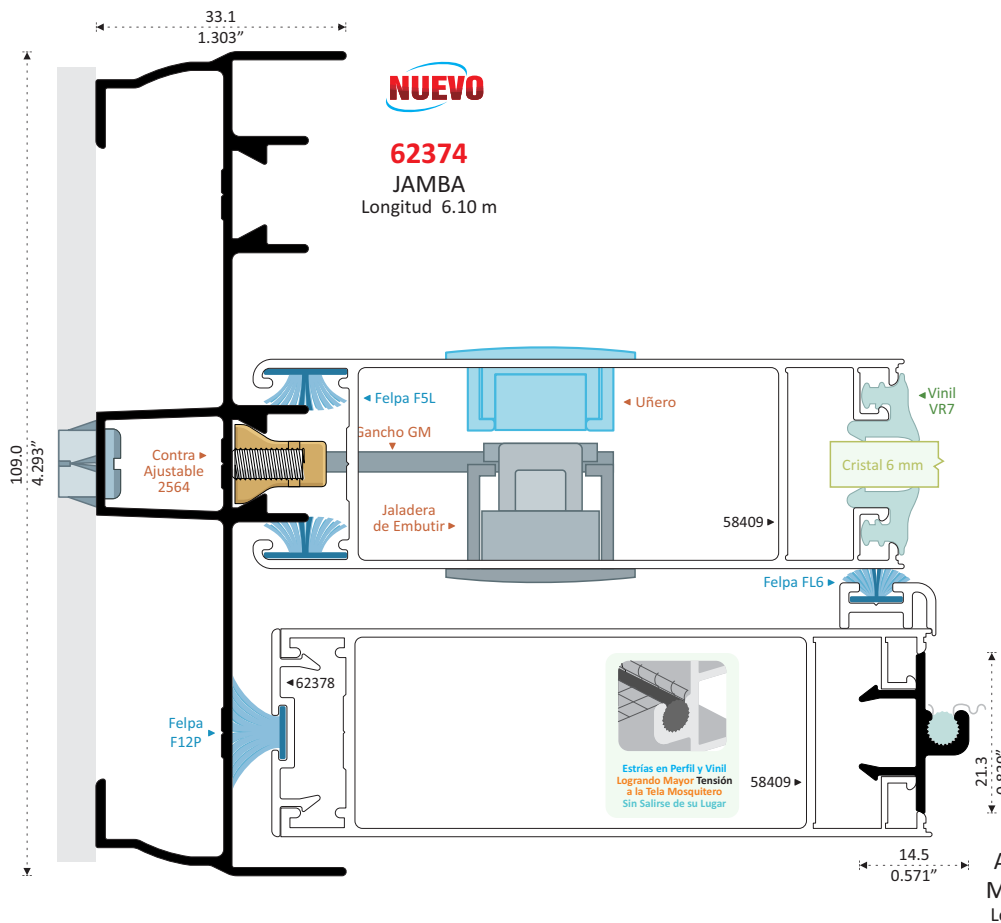
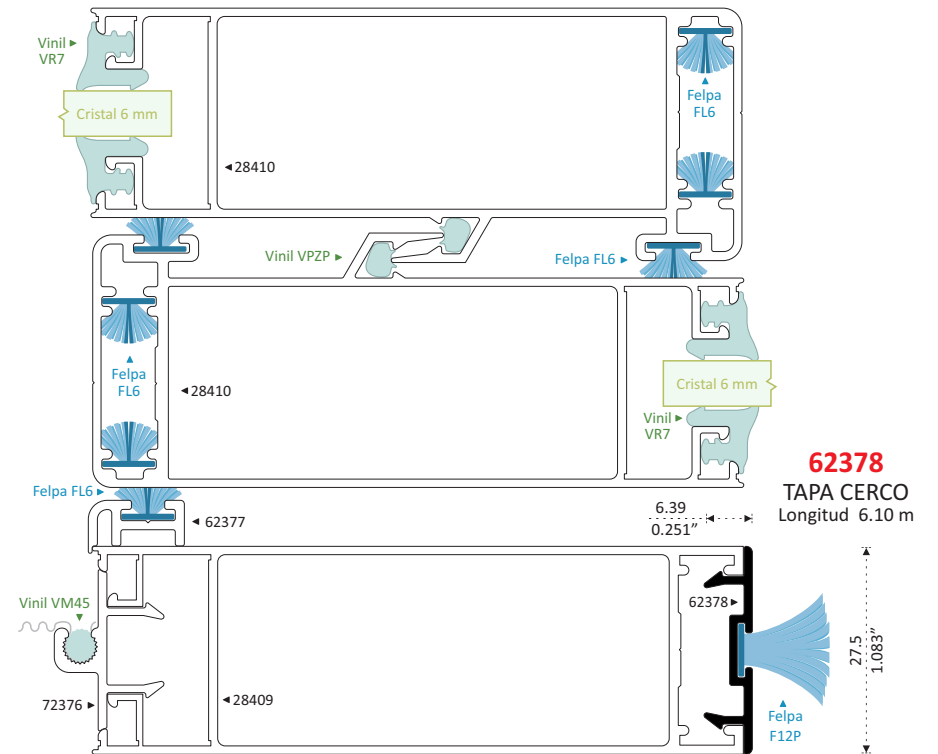
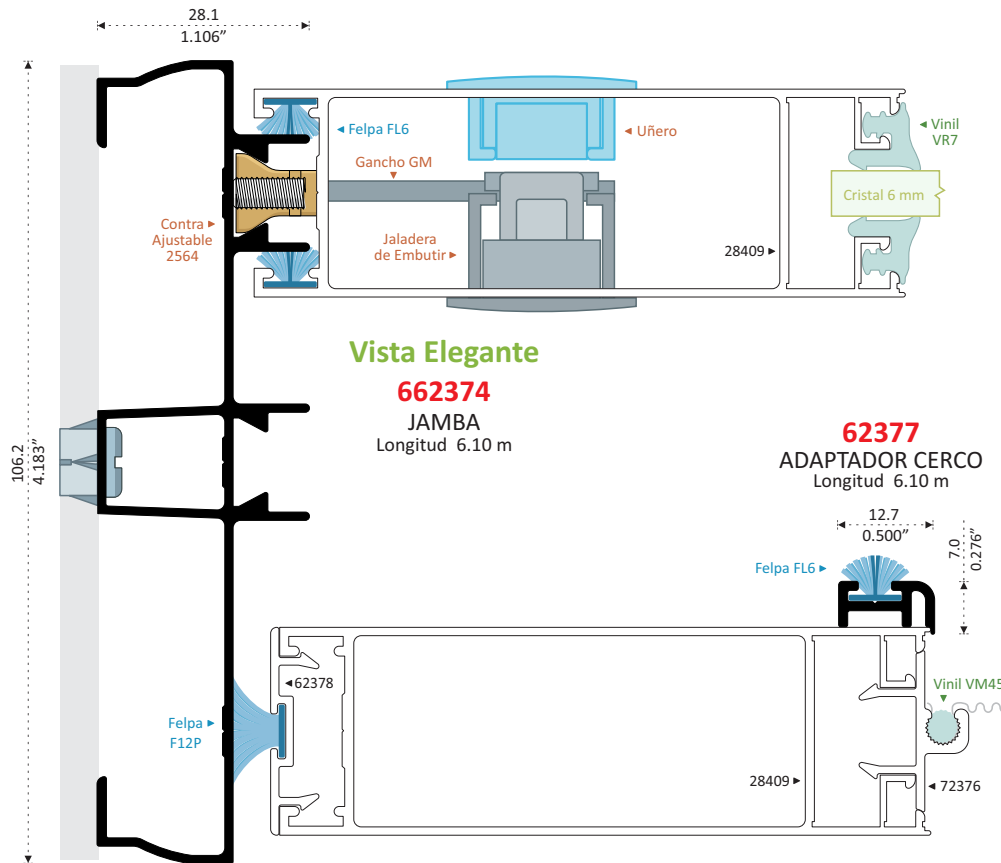

Tres Hojas Corredizas Ocultables en Muro

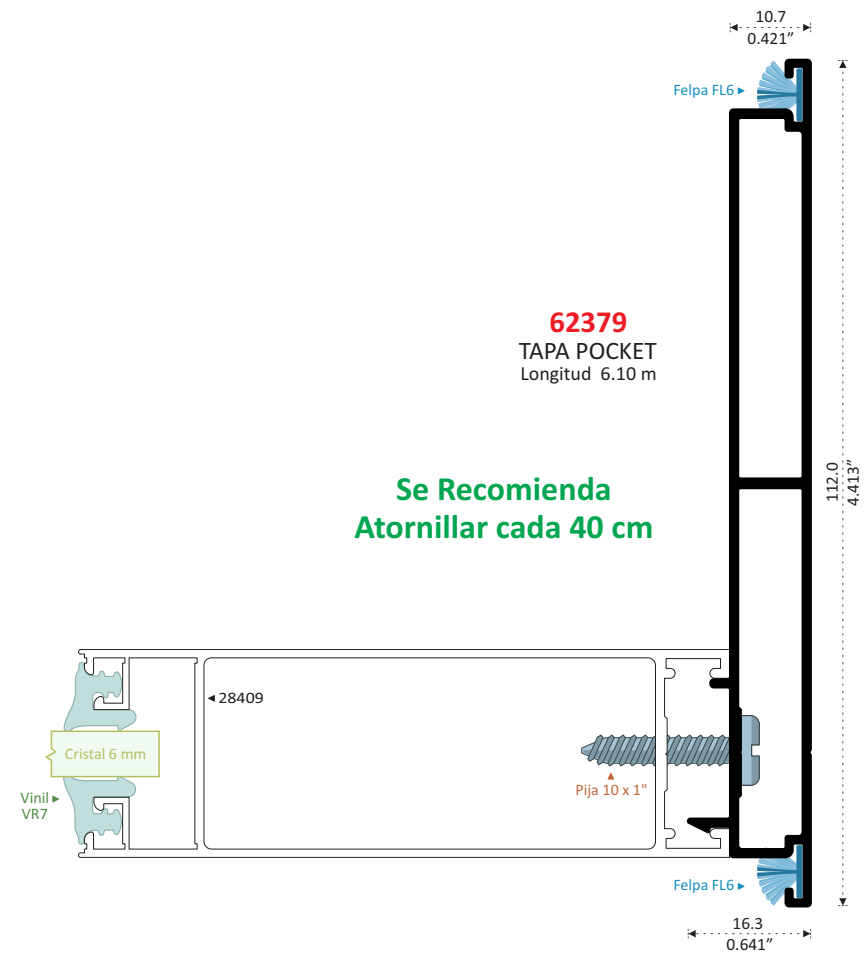
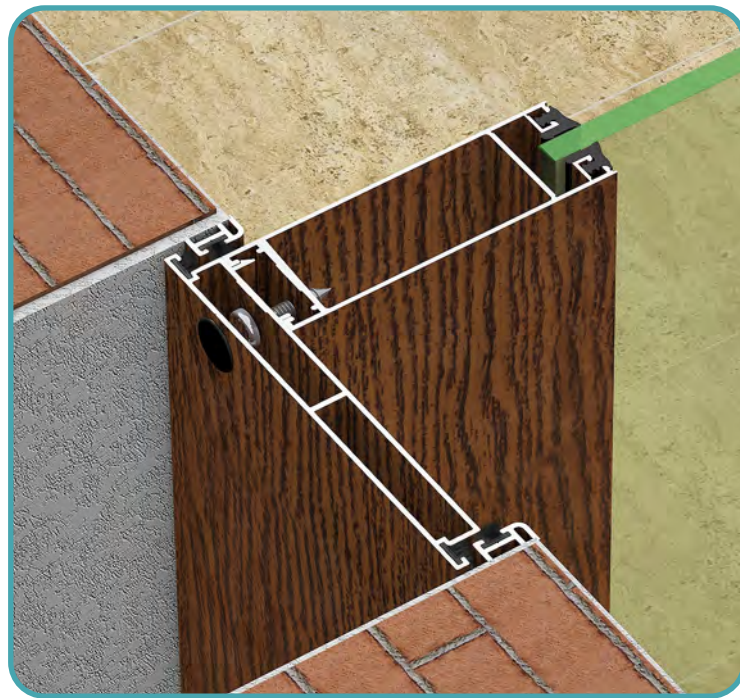
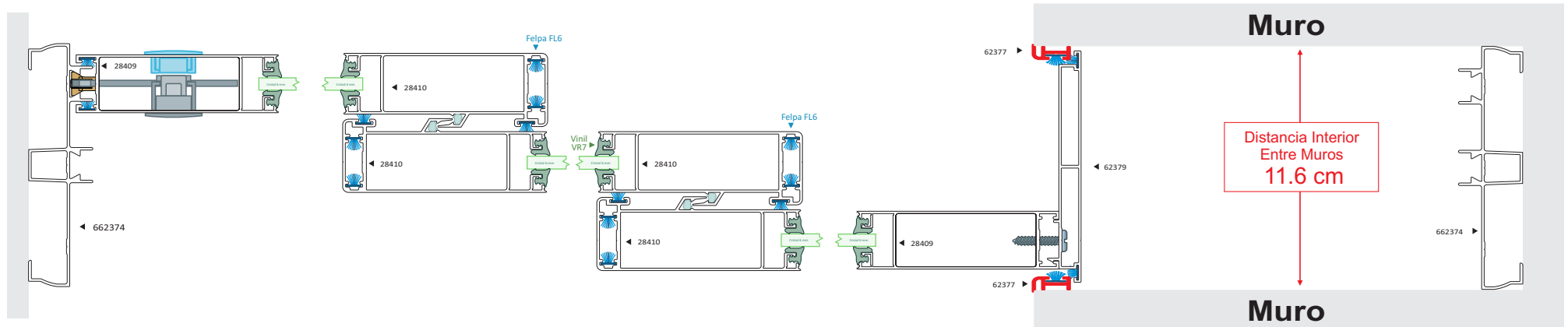

Aumenta la Hermeticidad Acústica, Colocando Vinil por Ambos Lados

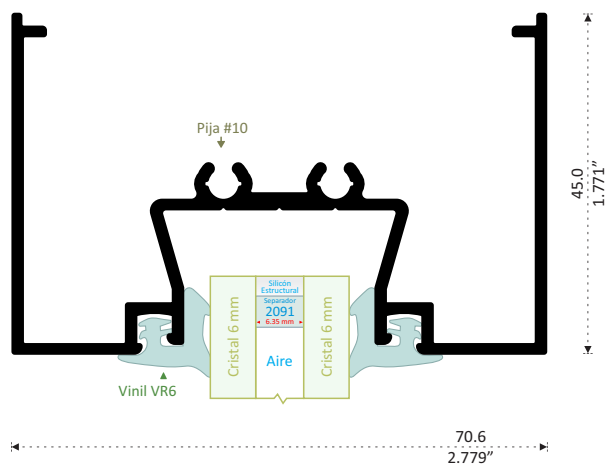
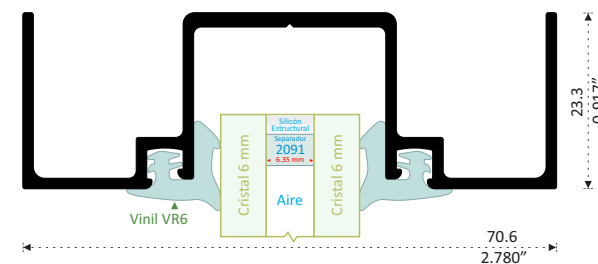
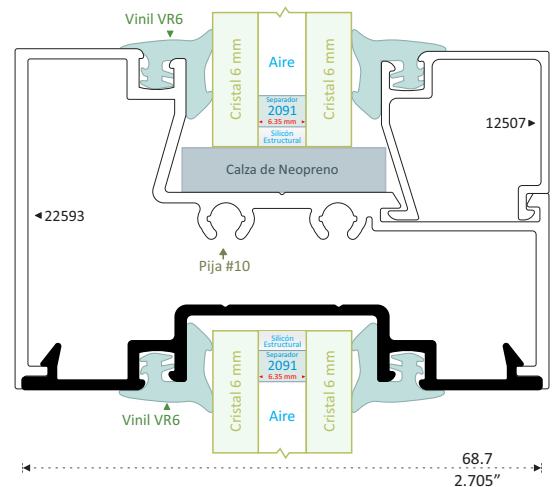
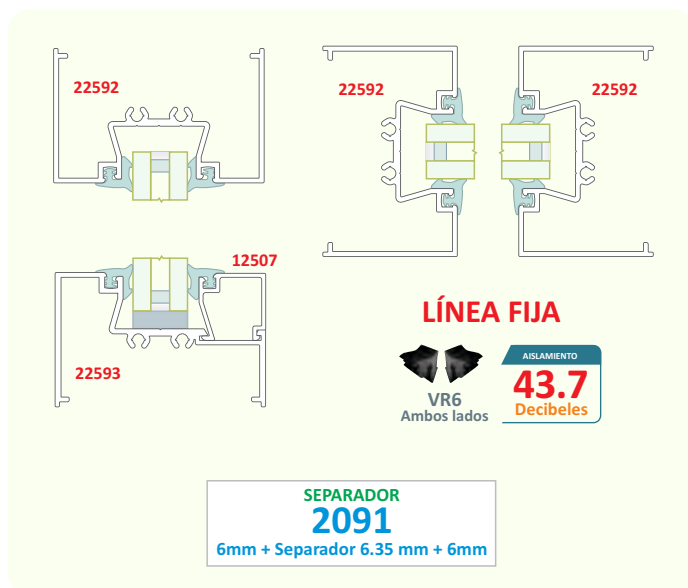

22503
MOLDURA UNIÓN
Longitud 6.10 m

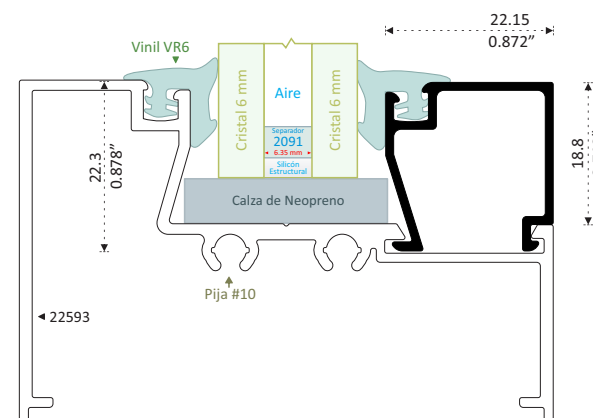
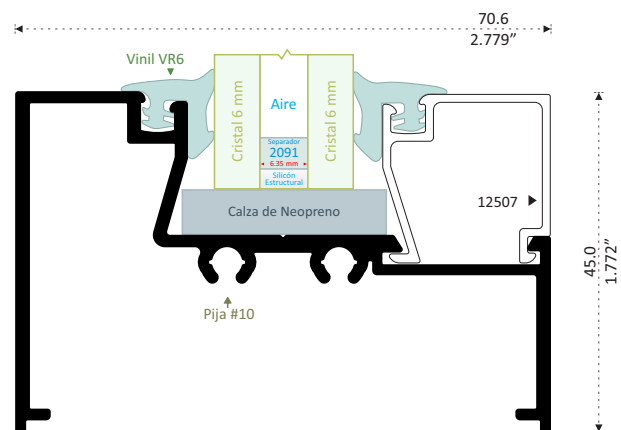
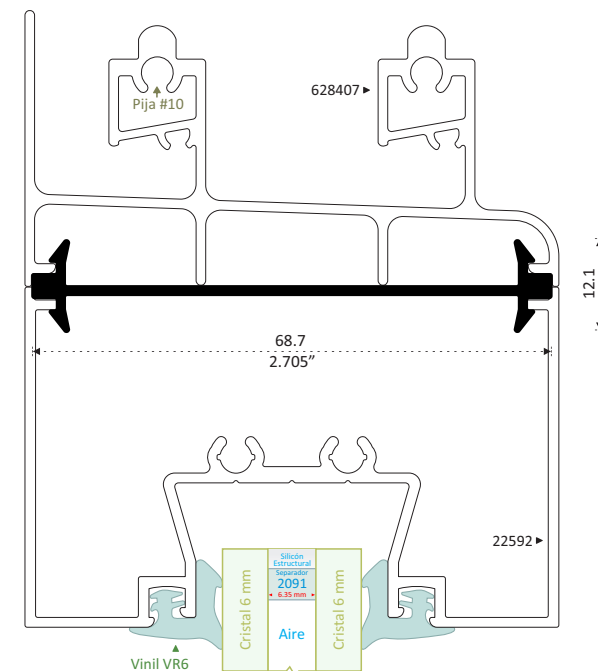
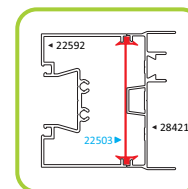

Aumenta la Hermeticidad Acústica, Colocando Vinil por Ambos Lados

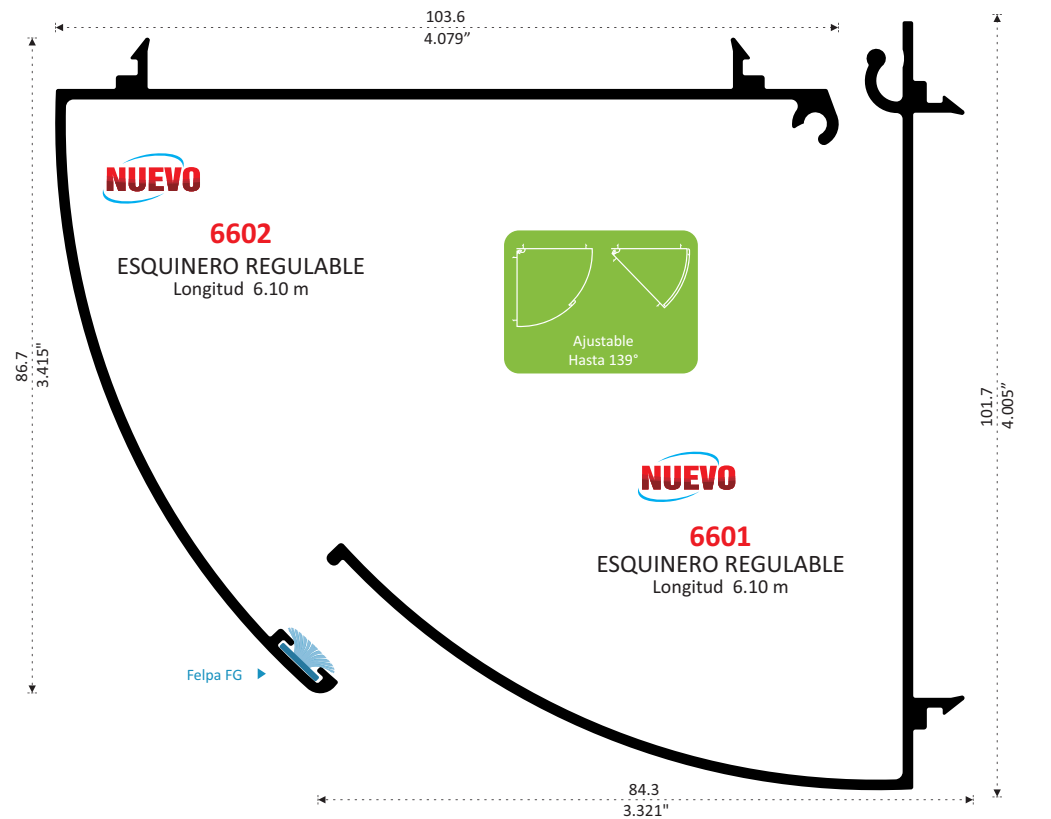
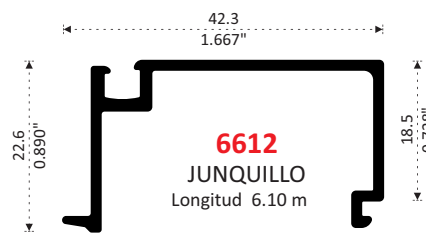
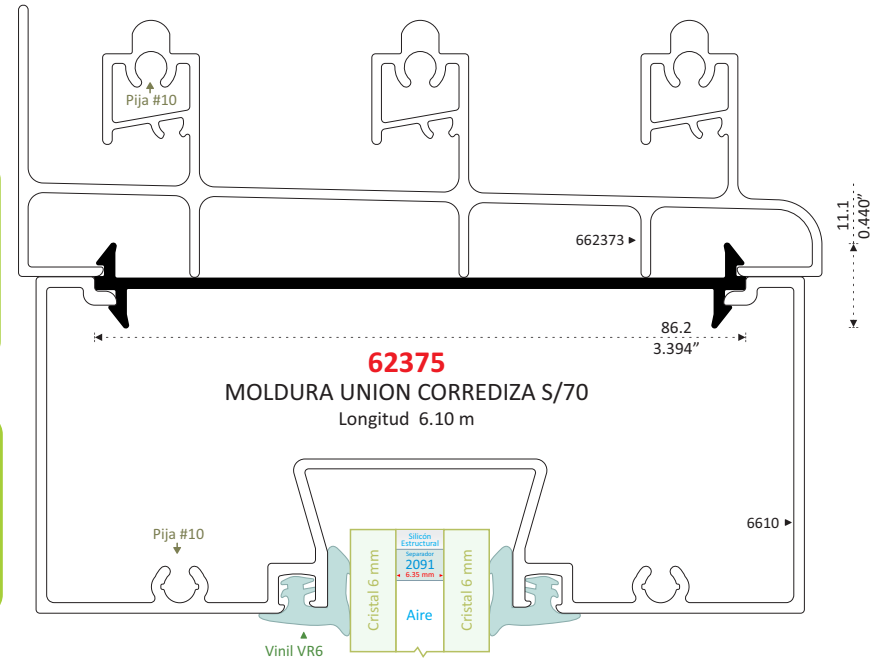
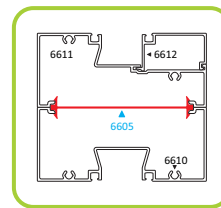
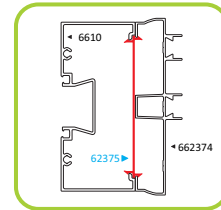
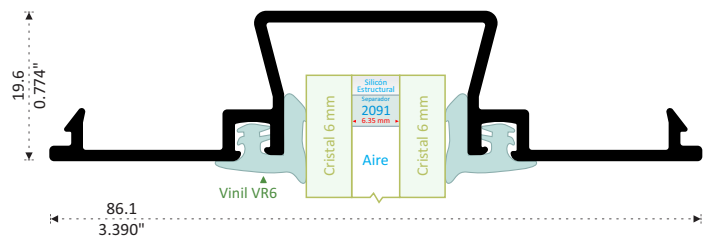
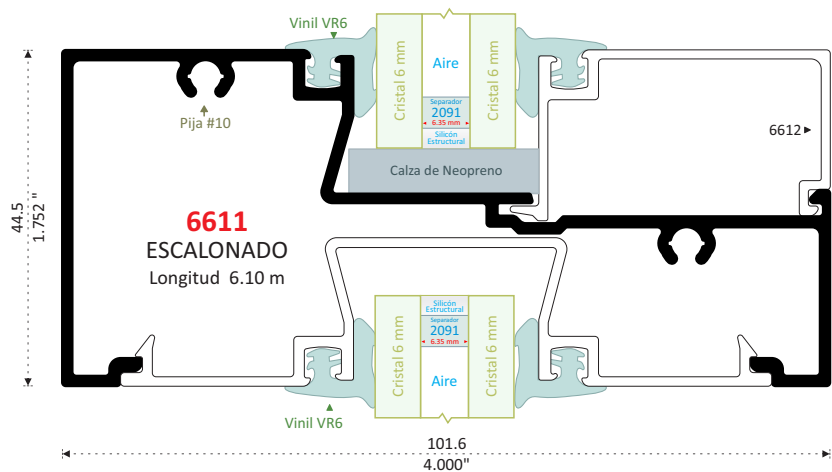
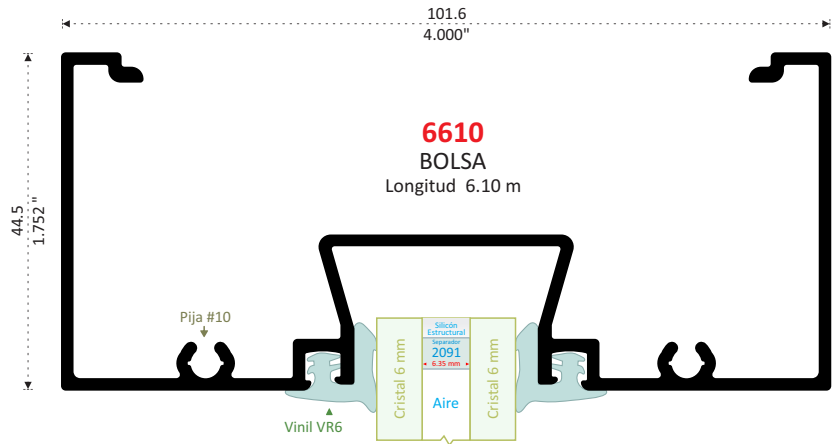
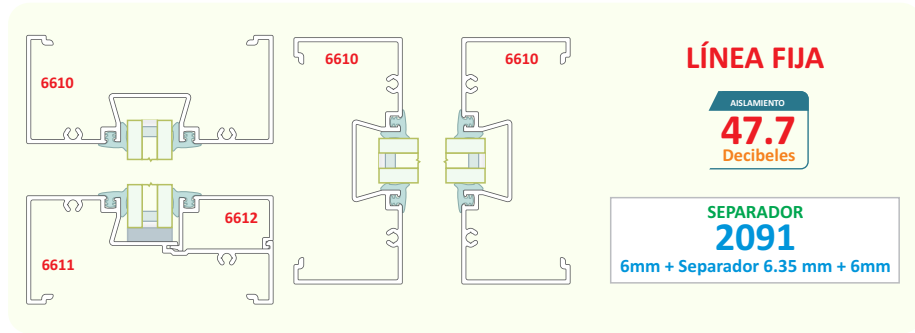



AISLAMIENTO ACÚSTICO

REALIZADO CON 120 DECIBELES AL EXTERIOR

MEDIDA 1.00 x 1.00 m

SEPARADOR
3106
6mm + Separador 4.7 mm + 6mm

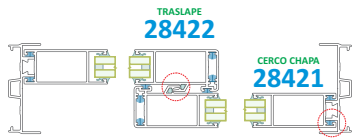

AISLAMIENTO 39.9 Decibeles

Perfiletto ALUMINUM
 17% Más Eficiente

DIVISIÓN TEXTIL 7 mm
Felpa FL6
Vinil VPZP
VC10 Ambos lados

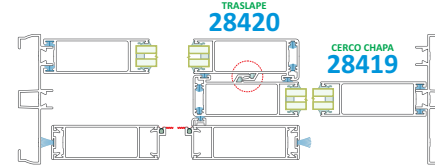

AISLAMIENTO 37.9 Decibeles

Perfiletto ALUMINUM

DIVISIÓN TEXTIL 7 mm
Felpa FL6
Vinil VPZP
VC10 Ambos lados



AISLAMIENTO 34.2 Decibeles

OTROS COMPETIDORES

7 mm
5 mm
Clave: FG Comercial
Vinil Cuña Interior

PERMEABILIDAD AL AGUA

DURANTE 20 MINUTOS



VENTANA MEDIDA 1.00 x 1.00 m

VELOCIDAD KM/H	Agua	Aire
20	50%	50%
40	50%	50%
60	50%	50%
80	50%	50%
100	50%	50%
120	60%	40%

SIN MOSQUITERO

Sin Filtraciones

MOSQUITERO CORREDIZO INTERIOR 11408, 18413 y 11411

Sin Filtraciones

MOSQUITERO CORREDIZO EXTERIOR 11408, 18413 y 11411

VELOCIDAD KM/H	Agua	Aire	Litros Filtrados
20	50%	50%	6.78
40	50%	50%	8.62
60	50%	50%	10.15
80	50%	50%	10.86
100	50%	50%	11.73
120	60%	40%	12.00

MOSQUITERO CORREDIZO EXTERIOR OCASIONA ALTA FILTRACIÓN DE AGUA



VENTANA MEDIDA 1.00 x 1.00 m

VELOCIDAD KM/H	Agua	Aire
20	50%	50%
40	50%	50%
60	50%	50%
80	50%	50%
100	50%	50%
120	60%	40%

SIN MOSQUITERO

Sin Filtraciones

MOSQUITERO CORREDIZO INTERIOR

Sin Filtraciones

MOSQUITERO CORREDIZO EXTERIOR

VELOCIDAD KM/H	Agua	Aire	Litros Filtrados
20	50%	50%	6.98
40	50%	50%	8.75
60	50%	50%	11.10
80	50%	50%	11.45
100	50%	50%	12.10
120	60%	40%	12.32

MOSQUITERO CORREDIZO EXTERIOR OCASIONA ALTA FILTRACIÓN DE AGUA



PUERTA MEDIDA 1.00 x 1.00 m

VELOCIDAD KM/H	Agua	Aire
20	50%	50%
40	50%	50%
60	50%	50%
80	50%	50%
100	50%	50%
120	60%	40%

SIN MOSQUITERO

Sin Filtraciones

MOSQUITERO CORREDIZO INTERIOR 11408, 18413 y 11411

Sin Filtraciones

MOSQUITERO CORREDIZO EXTERIOR 11408, 18413 y 11411

VELOCIDAD KM/H	Agua	Aire	Litros Filtrados
20	50%	50%	6.85
40	50%	50%	8.70
60	50%	50%	10.50
80	50%	50%	11.10
100	50%	50%	12.00
120	60%	40%	12.24

MOSQUITERO CORREDIZO EXTERIOR OCASIONA ALTA FILTRACIÓN DE AGUA



PUERTA MEDIDA 1.00 x 1.00 m

VELOCIDAD KM/H	Agua	Aire
20	50%	50%
40	50%	50%
60	50%	50%
80	50%	50%
100	50%	50%
120	60%	40%

SIN MOSQUITERO

Sin Filtraciones

MOSQUITERO CORREDIZO INTERIOR

Sin Filtraciones

MOSQUITERO CORREDIZO EXTERIOR

VELOCIDAD KM/H	Agua	Aire	Litros Filtrados
20	50%	50%	7.10
40	50%	50%	9.15
60	50%	50%	11.23
80	50%	50%	11.65
100	50%	50%	12.25
120	60%	40%	12.55

MOSQUITERO CORREDIZO EXTERIOR OCASIONA ALTA FILTRACIÓN DE AGUA

PERMEABILIDAD AL VIENTO

Medida 1.00 x 1.00 m

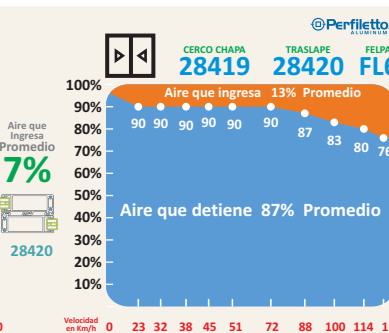
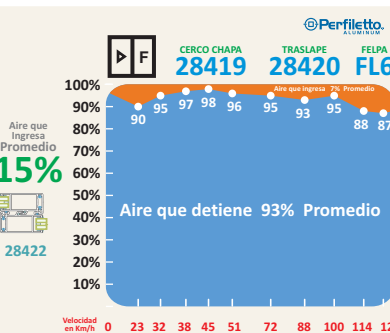
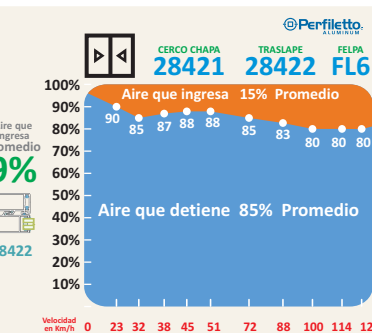
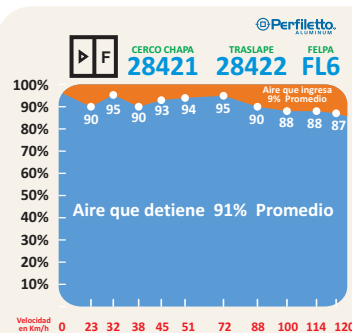

RESISTENCIAS A VIENTOS

VENTANA

Prueba Realizada
30 Repeticiones de 1 Minuto c/u
A 120 Km/h
Medida 1.00 x 1.00 m
Dos Cristales 6 mm
LOS PERFILES SIN DEFORMACIÓN
 CONSERVAN SU FUNCIONAMIENTO

PUERTA

Prueba Realizada
30 Repeticiones de 1 Minuto c/u
A 120 Km/h
Medida 2.00 X 2.10 m
Dos Cristales 6 mm
LOS PERFILES SIN DEFORMACIÓN
 CONSERVAN SU FUNCIONAMIENTO

C O M P E T I D O R

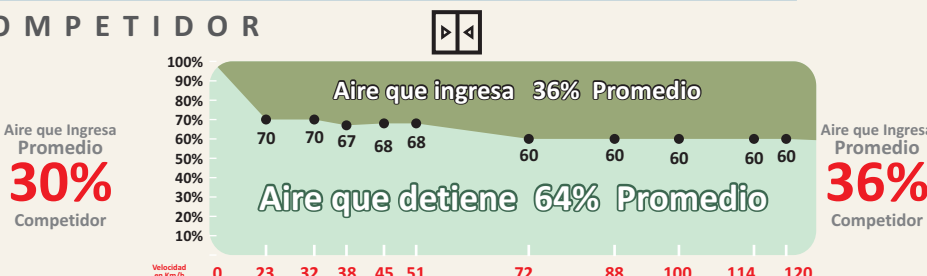
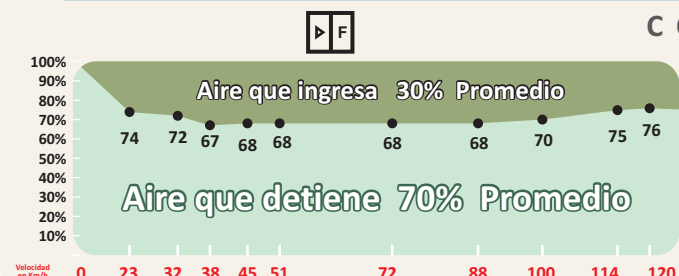

Aumenta la Hermeticidad Acústica, Colocando Vinil por Ambos Lados

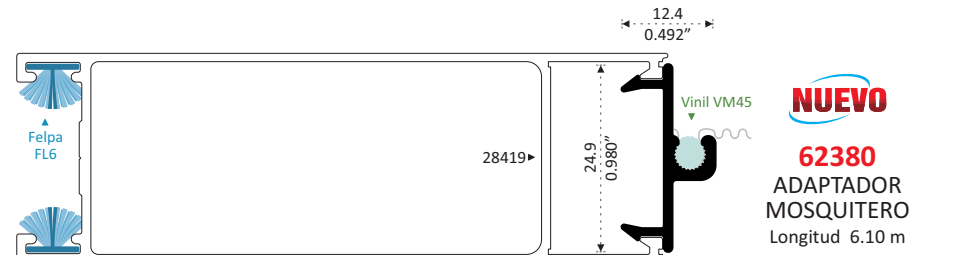
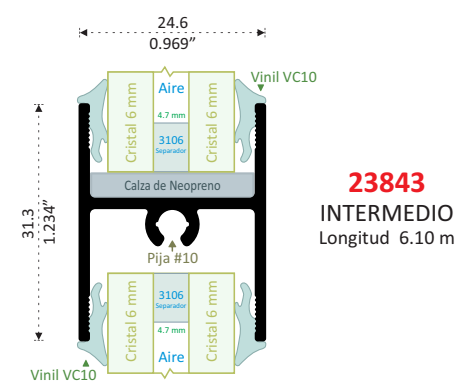
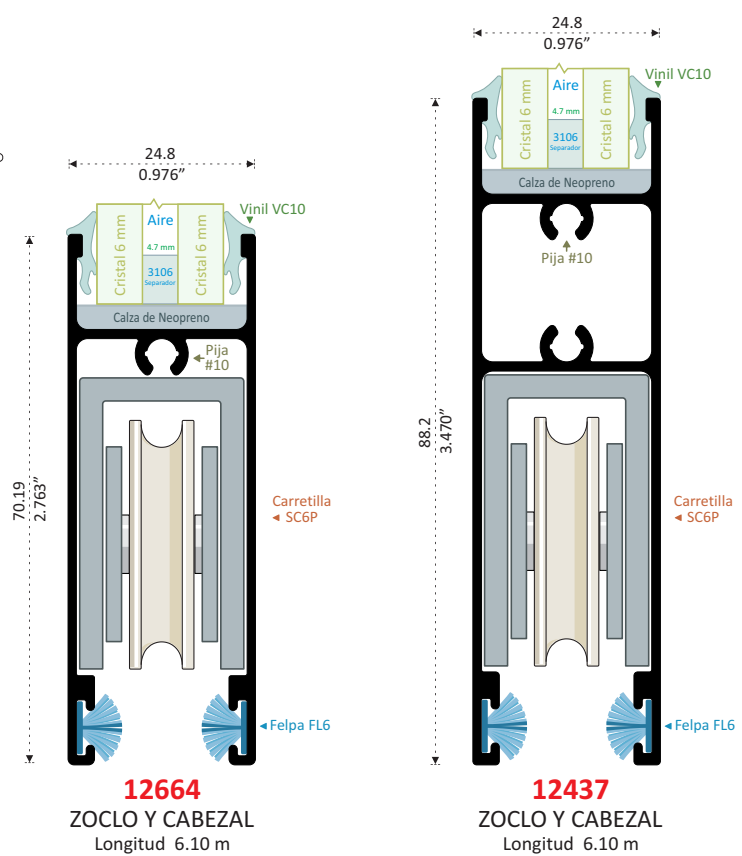
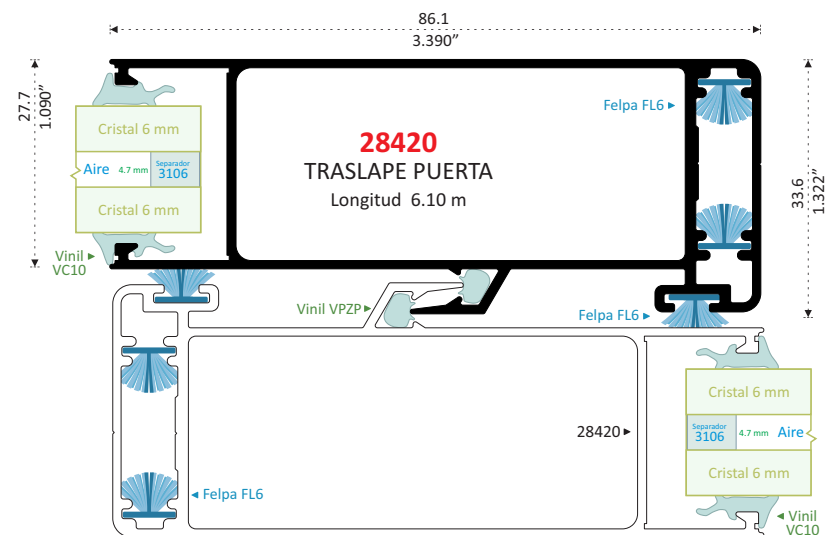
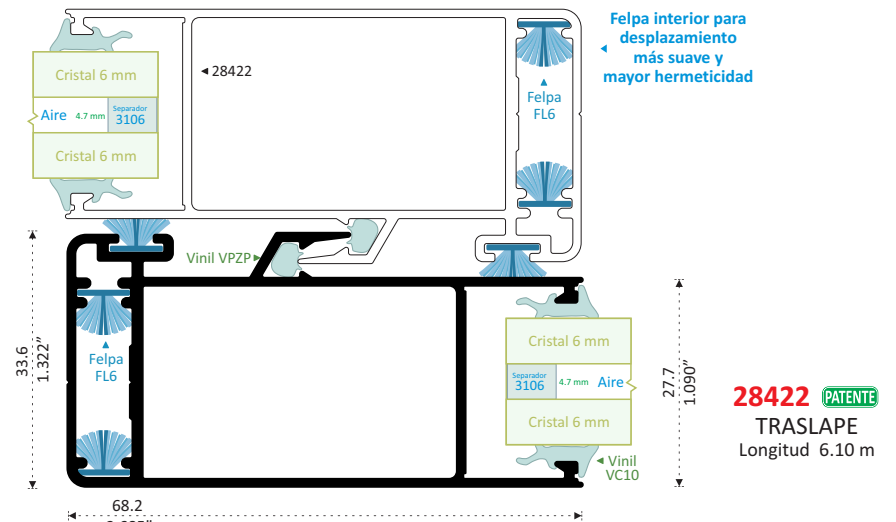
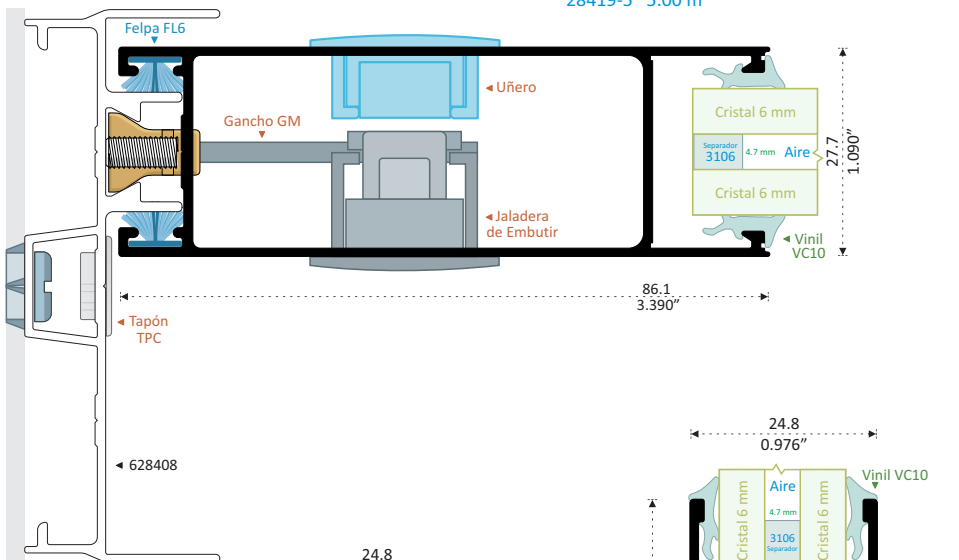
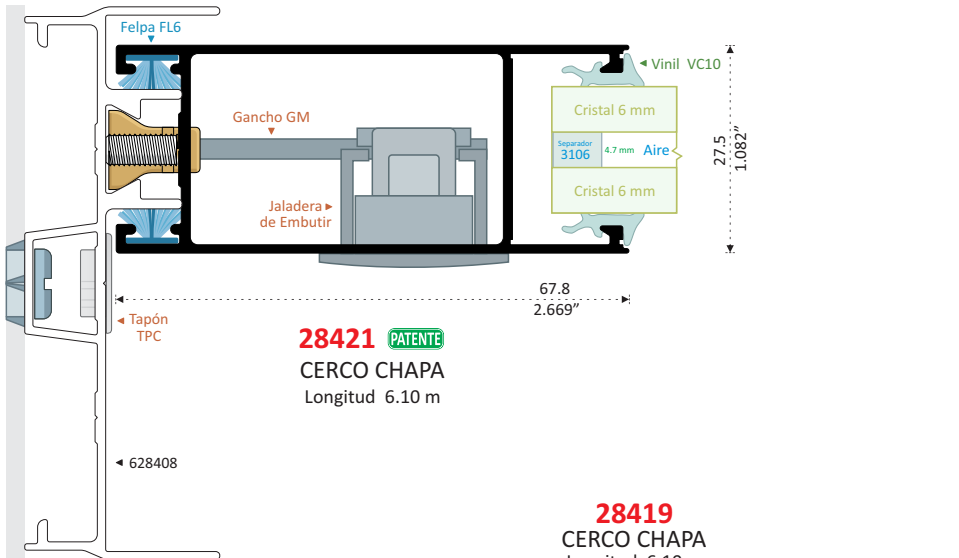

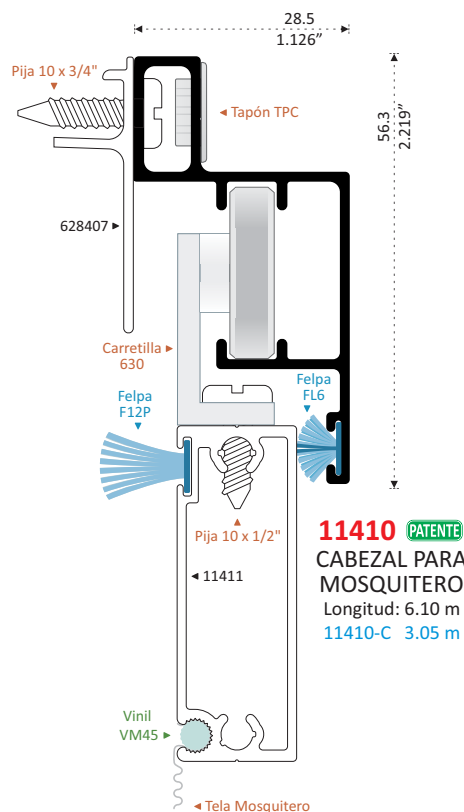

Estrias en Perfil y Vinil
Logrando Mayor Tensión
a la Tela Mosquitero
Sin Salirse de su Lugar

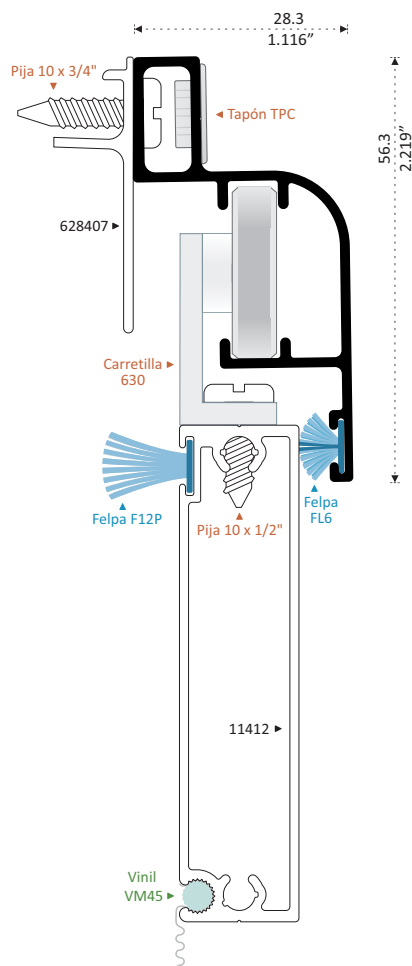

11408 PATENTE
CABEZAL
COLONIAL
MOSQUITERO
Longitud 6.10 m
11408-C 3.05 m

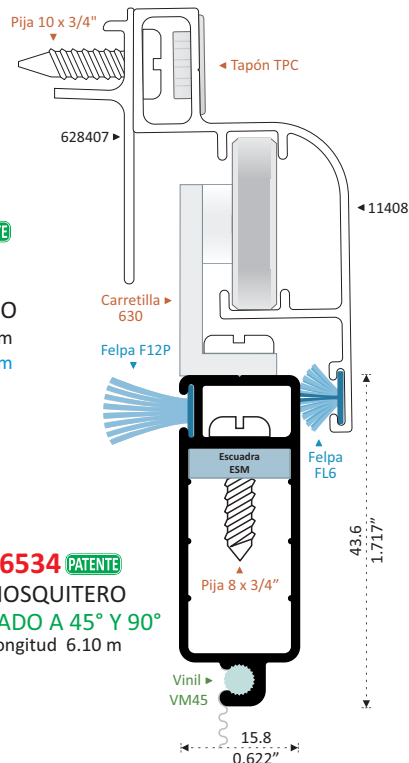

46534 PATENTE
MOSQUITERO
ARMADO A 45° Y 90°
Longitud 6.10 m

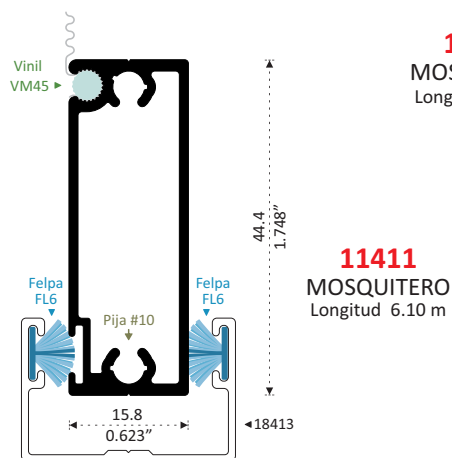

11411
MOSQUITERO
Longitud 6.10 m

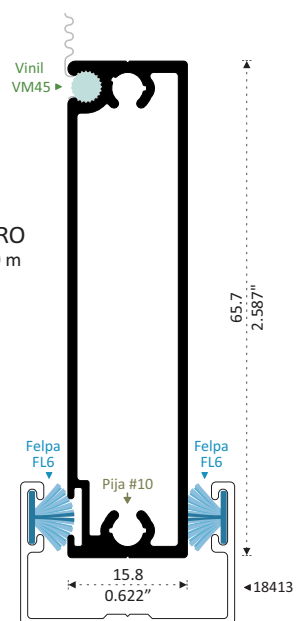

11412
MOSQUITERO
Longitud 6.10 m

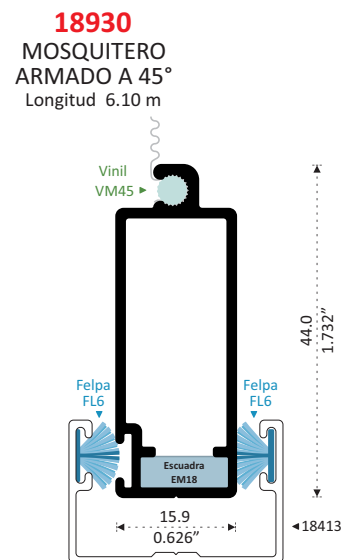

18930
MOSQUITERO
ARMADO A 45°
Longitud 6.10 m



Estrias en Perfil y Vinil
Logrando Mayor Tensión
a la Tela Mosquitero
Sin Salirse de su Lugar

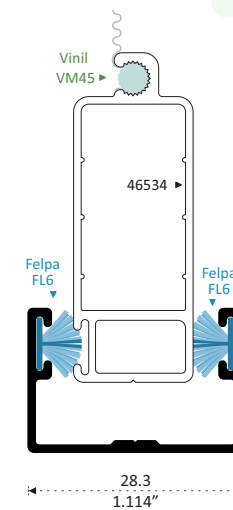

18413
JAMBA
Longitud 6.10 m
18413DREN
Longitud 6.10 m
18413D-C
Longitud 3.05 m
Drenes cada 40 cm
sin Costo

Armar El Marco de la Hoja con Escudra de Botón Hasta 20 Kg.

Más de 20 Kg. Armar con Escudra de Aluminio

Marco de Hoja 54395 con Escudra EM50

AJUSTA Y CIERRA EL CORTE

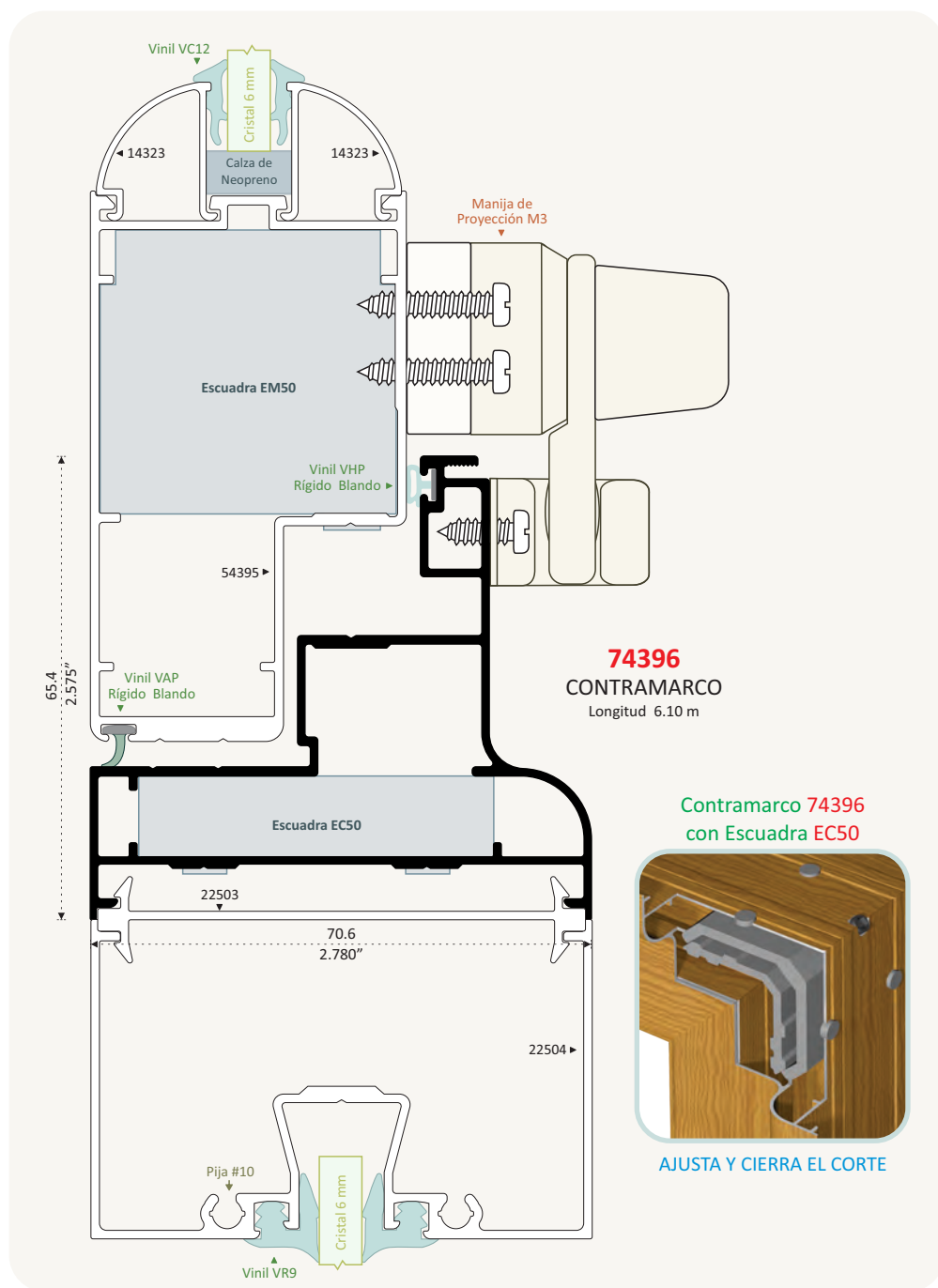
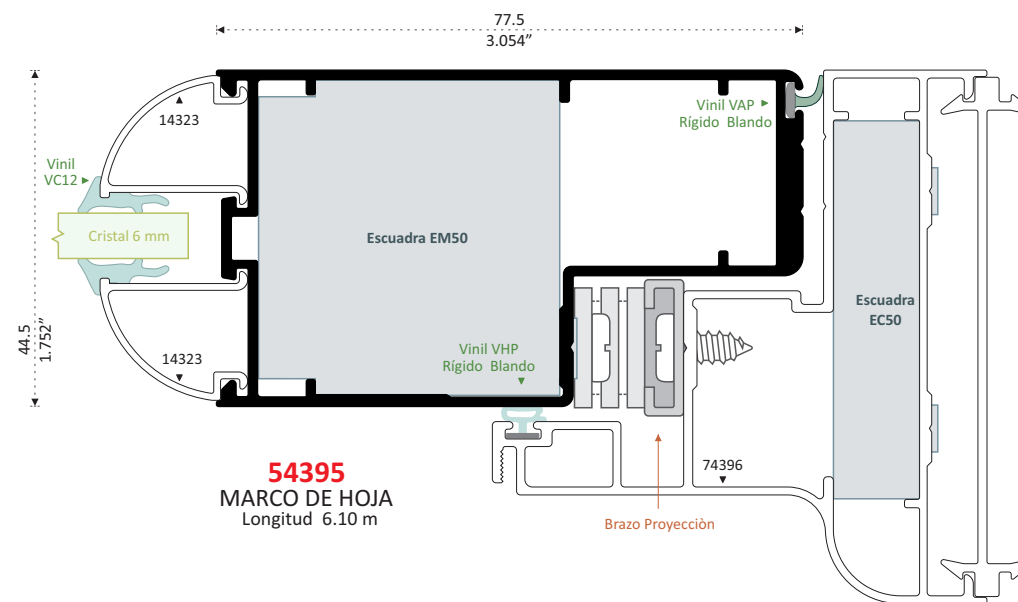

Contramarco 74396 con Escudra EC50

AJUSTA Y CIERRA EL CORTE

Estrías en Perfil y Vinil Logrando Mayor Tensión a la Tela Mosquitero Sin Salirse de su Lugar

5.4
0.213"

21.4
0.845"

ESCUADRA 1781

25173 PATENTE MOSQUITERO Longitud 6.10 m

JUNQUILLOS PUERTA MULTIDISEÑOS

412543 22576 412576 12543

32576 14323 46370

76370 24323 24324 24331

24327 24328 24330

22603 12604

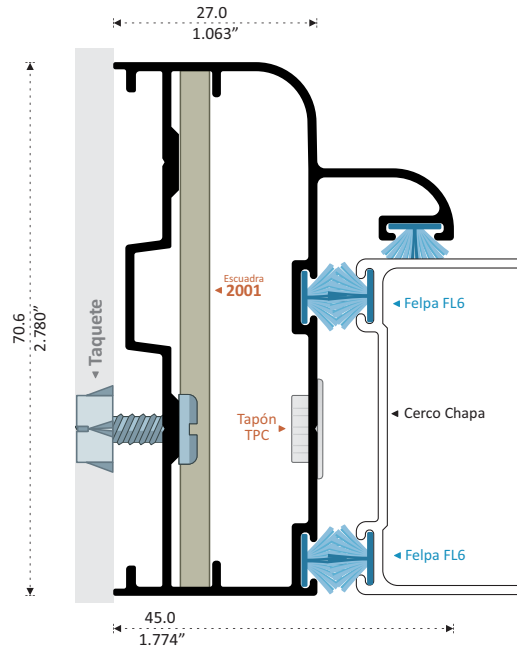

12618
BATIENTE
COLONIAL
Longitud 6.10 m

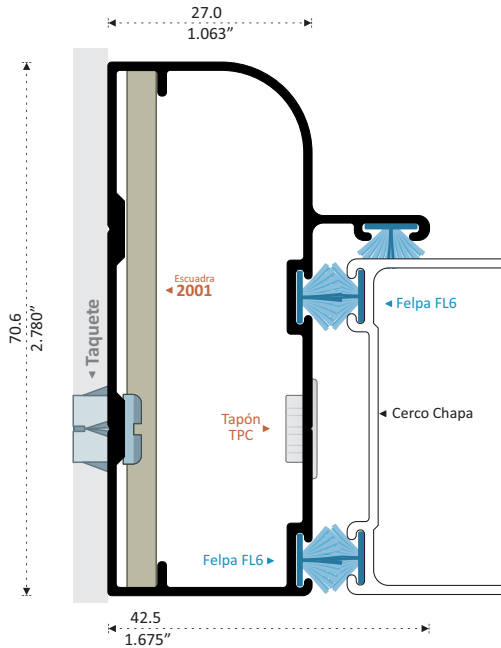

22757
BATIENTE
COLONIAL
Longitud 6.10 m

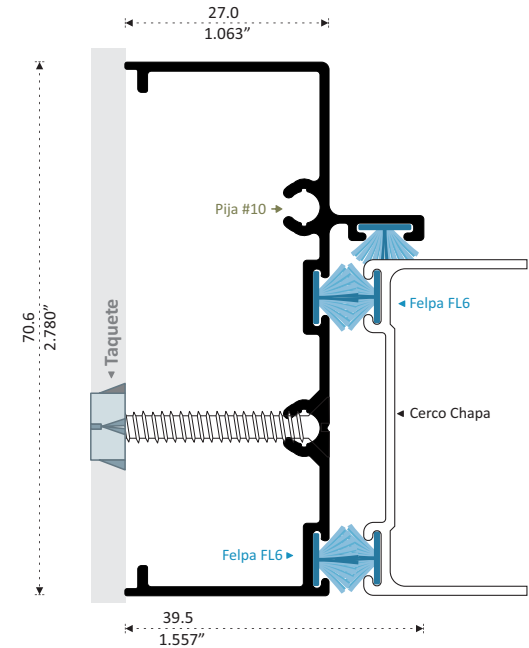

12757
BATIENTE
Longitud 6.10 m

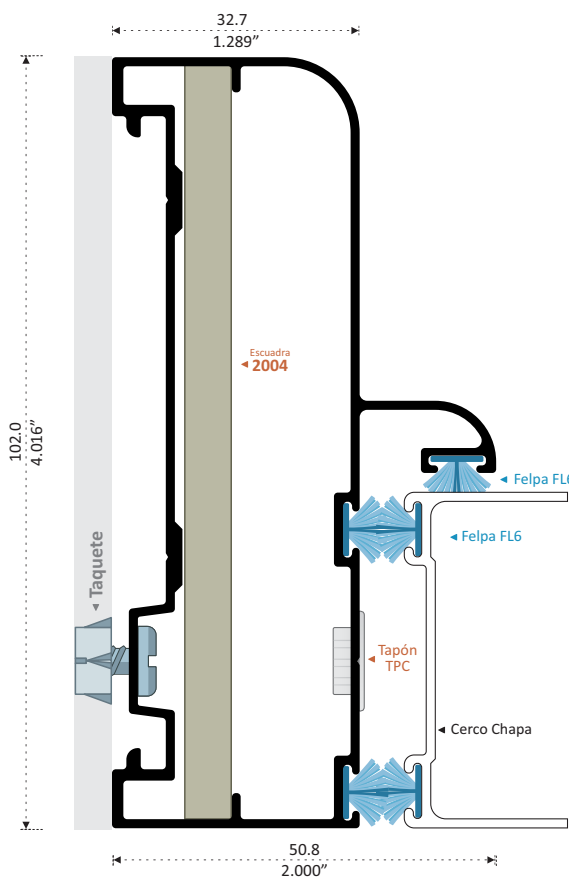

12619 PATENTE
BATIENTE COLONIAL
Longitud 6.10 m

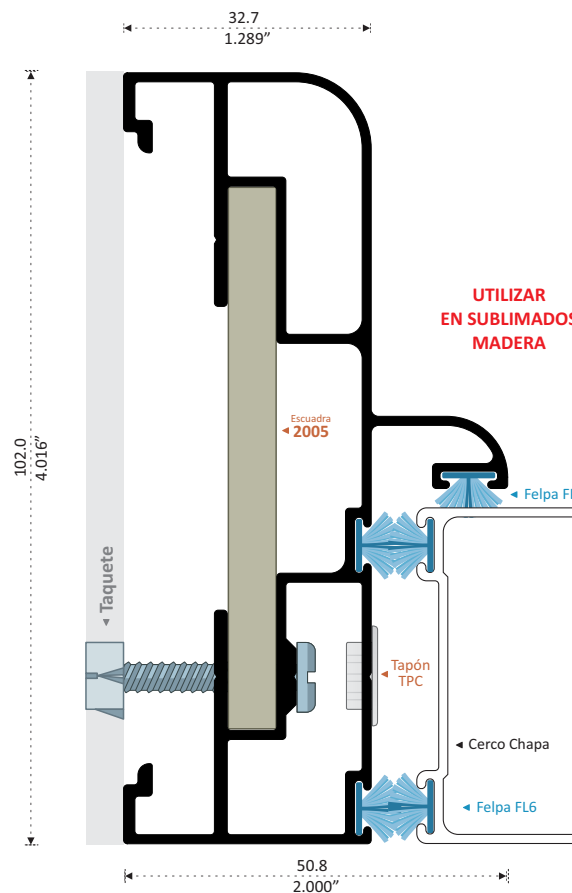

22619 PATENTE
BATIENTE COLONIAL
Longitud 6.10 m

UTILIZAR
EN SUBLIMADOS
MADERA





 **Perfiletto**[®]
ALUMINUM

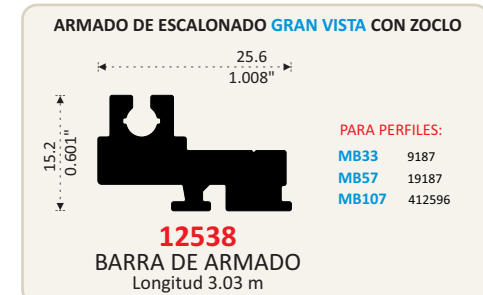
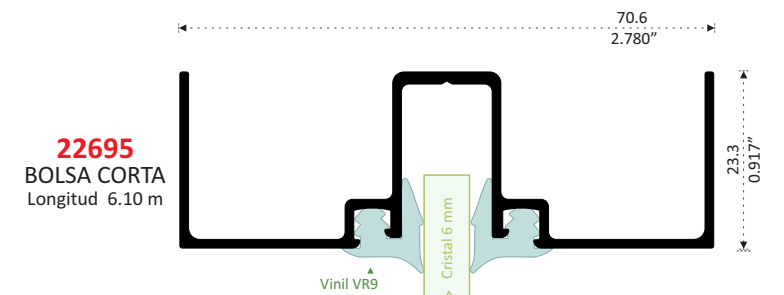
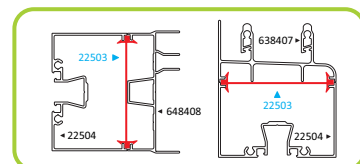
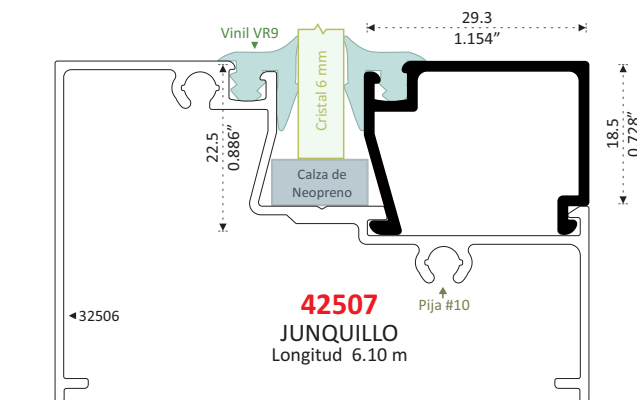
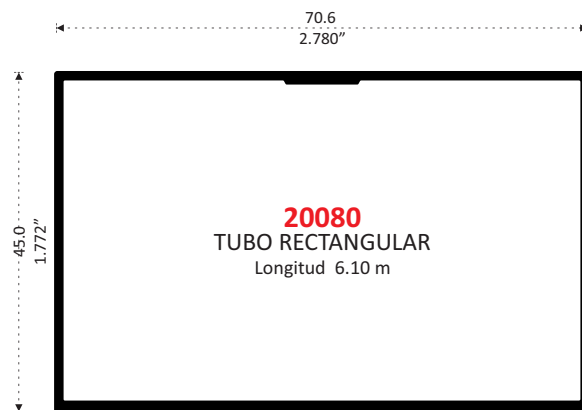
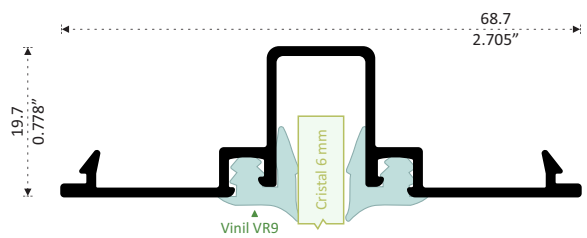
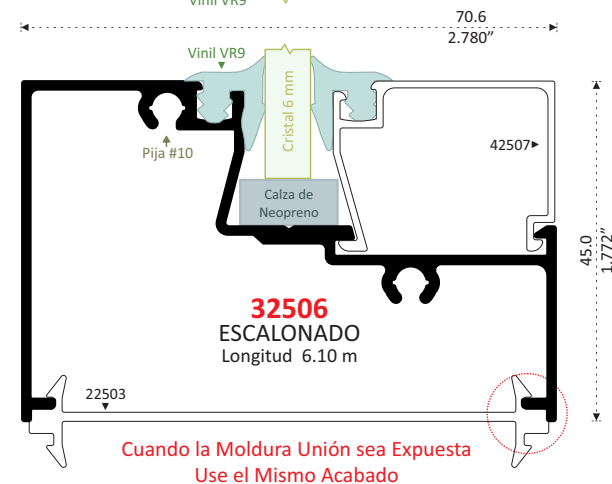
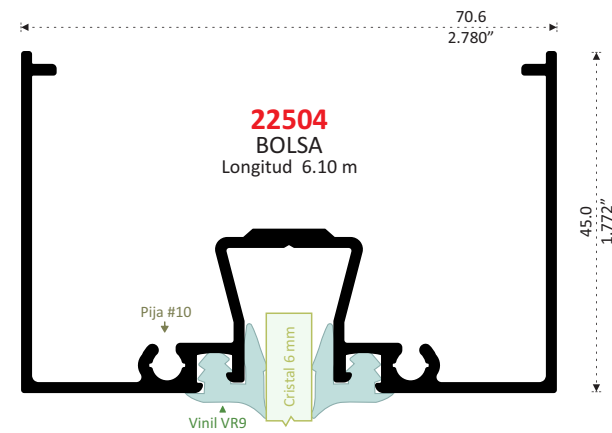
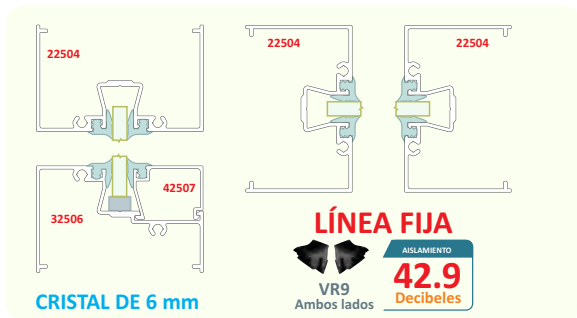

LÍNEA SERIE 80 VINIL RESPALDO

Convierte un Producto Perfiletto En Extraordinario

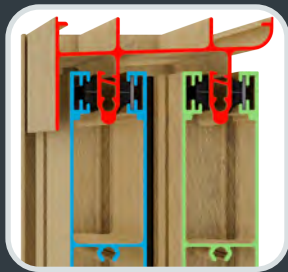

Riel Doble Guía Opcional Dos Hojas Móviles

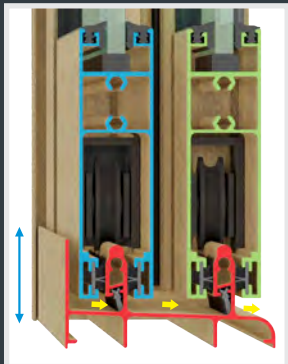

Mejor Salida de Agua por:
- Riel con Pared Interior Alta
- Inclinación de Riel
- Drenes Inferiores

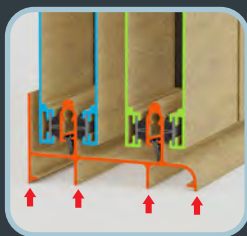

Resistencia de 4 Puntos de Apoyo para Cristales Pesados

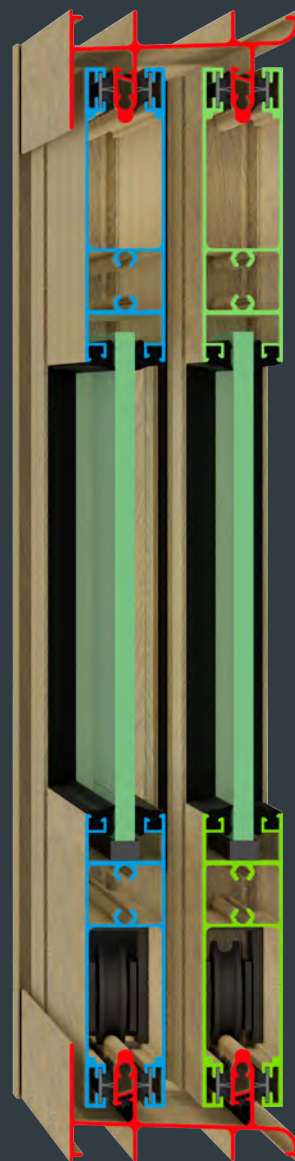

Mayor Hermeticidad por Doble Felpa entre Zoclo y Riel

Mayor Hermeticidad por Rozamiento de Felpas F5L con Labios Textiles



2 Felpas Horizontales en Zoclo

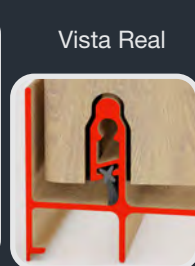

Vista Real



2 Felpas Verticales en Traslapes

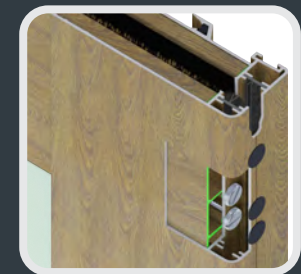

Zoclo Entra Hasta el Fondo de Cerco Chapa y Traslape

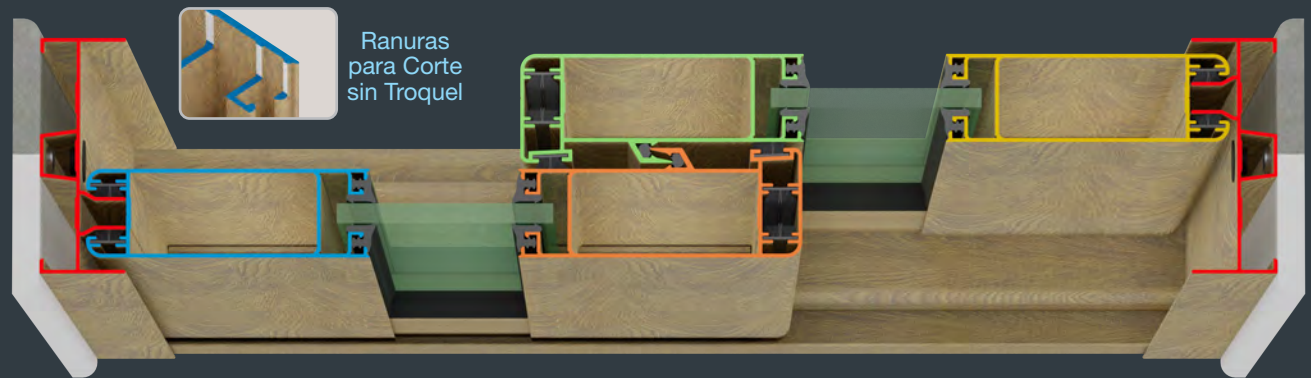

Ranuras para Corte sin Troquel

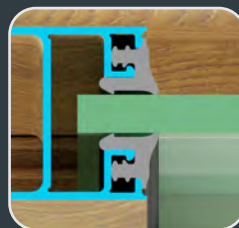

Mayor Firmeza de Vinilos Respaldo

Doble Vinil Respaldo Aumenta Aislamiento Acústico



Hermeticidad entre Traslapes por 2 Vinilos VPZP y 6 Felpas

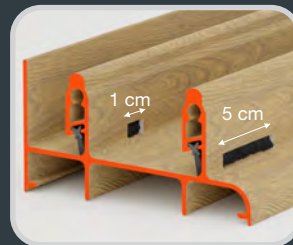

Aumentan la Hermeticidad:

- Aislamiento Acústico
- Resistencia a Viento
- Filtra Polvo
- Salida de Agua
- Impide Entrada de Insectos

Riel Inferior Incluye Drenes cada 40 cm Colocar Felpa F11P

Descubre otras Opciones para tu Cancelería

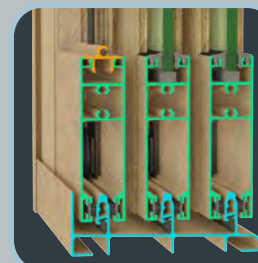

Mosquitero Interior Riel Triple

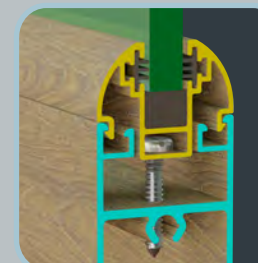

Adaptador Curvo

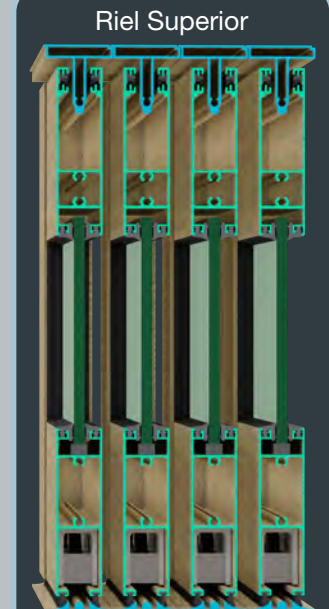

Riel Sencillo a Piso

Instale las hojas que Requiera

Riel Superior

■ Aislamiento Acústico Con 68410 43.1 Decibles

■ Permeabilidad a Viento y Polvo Aire que Detiene 89 %

■ Resistencia A Vientos Sin Deformar el Perfil Ventana 120 Km/h Puerta 120 Km/h

CORREDIZA SERIE 80 VINIL RESPALDO

PRUEBAS EN NUESTRO CENTRO DE INVESTIGACIÓN Y DESARROLLO
Armadas con Perfiles y Complementos Esenciales 100% Perfiletto

AI SLAM IENTO ACÚSTICO

REALIZADO CON 120 DECIBELES AL EXTERIOR
MEDIDA 1.00 x 1.00 m

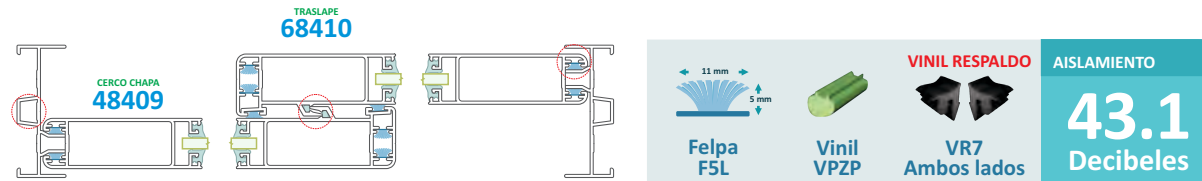

LÍNEA EXCLUSIVA PERFILETTO

PERMEABILIDAD AL AGUA DURANTE 20 MINUTOS

VENTANA MEDIDA 1.00 x 1.00 m

VELOCIDAD KM/H	Agua	Aire
20	50%	50%
40	50%	50%
60	50%	50%
80	50%	50%
100	50%	50%
120	60%	40%

SIN MOSQUITERO
Sin Filtraciones

MOSQUITERO CORREDIZO INTERIOR 11408, 18413 y 11411
Sin Filtraciones

MOSQUITERO CORREDIZO EXTERIOR 11408, 18413 y 11411

VELOCIDAD KM/H	Agua	Aire	Litros Filtrados
20	50%	50%	2.46
40	50%	50%	2.82
60	50%	50%	2.95
80	50%	50%	3.12
100	50%	50%	3.26
120	60%	40%	3.42

MOSQUITERO CORREDIZO EXTERIOR
OCASIONA ALTA FILTRACIÓN DE AGUA

PUERTA MEDIDA 1.00 x 1.00 m

VELOCIDAD KM/H	Agua	Aire
20	50%	50%
40	50%	50%
60	50%	50%
80	50%	50%
100	50%	50%
120	60%	40%

SIN MOSQUITERO
Sin Filtraciones

MOSQUITERO CORREDIZO INTERIOR 11408, 18413 y 11411
Sin Filtraciones

MOSQUITERO CORREDIZO EXTERIOR 11408, 18413 y 11411

VELOCIDAD KM/H	Agua	Aire	Litros Filtrados
20	50%	50%	2.50
40	50%	50%	2.93
60	50%	50%	3.00
80	50%	50%	3.28
100	50%	50%	3.39
120	60%	40%	3.50

MOSQUITERO CORREDIZO EXTERIOR
OCASIONA ALTA FILTRACIÓN DE AGUA

PERMEABILIDAD AL VIENTO Medida 1.00 x 1.00 m

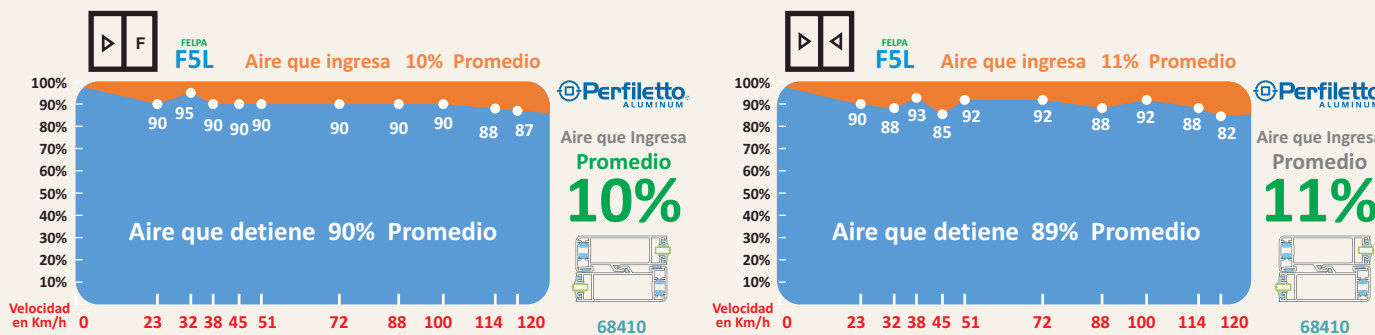

LÍNEA EXCLUSIVA PERFILETTO

RESISTENCIAS A VIENTOS

VENTANA
Prueba Realizada
30 Repeticiones de 1 Minuto c/u
A 120 Km/h
Medida 1.00 x 1.00 m
Cristal 6 mm
LOS PERFILES SIN DEFORMACIÓN
CONSERVAN SU FUNCIONAMIENTO

PUERTA
Prueba Realizada
30 Repeticiones de 1 Minuto c/u
A 120 Km/h
Medida 2.00 X 2.10 m
Cristal 6 mm
LOS PERFILES SIN DEFORMACIÓN
CONSERVAN SU FUNCIONAMIENTO

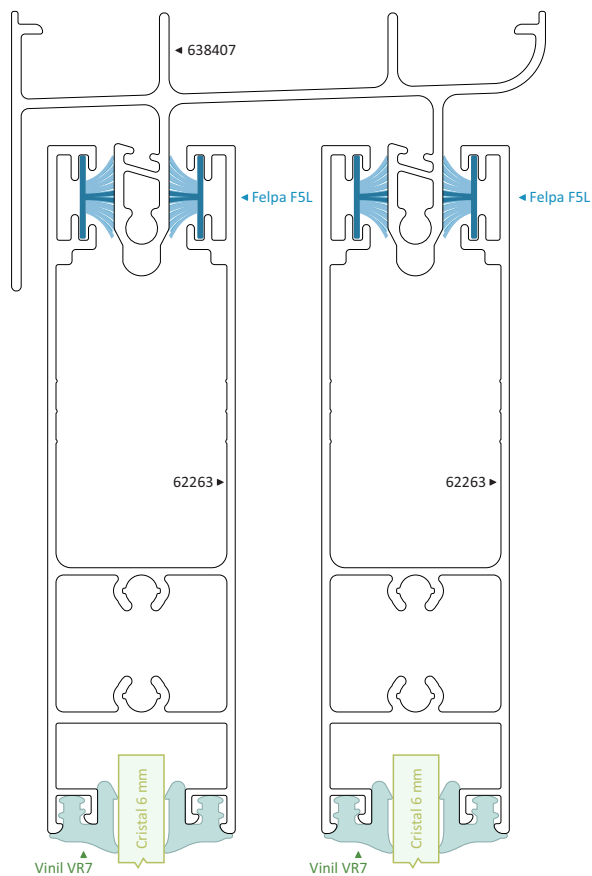

68411
INTERMEDIO
Longitud 6.10 m

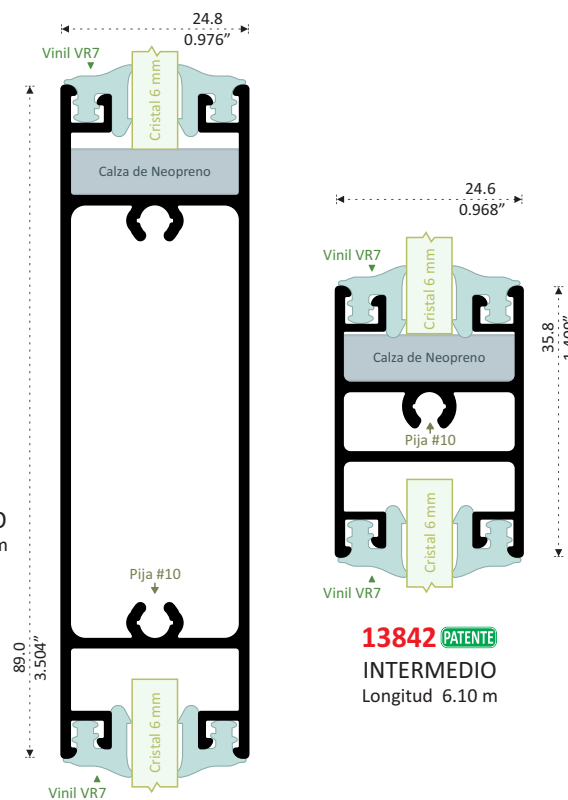

MAYOR VISTA Y VINILOS OCULTOS

24.8
0.976"

Vinil V4

Cristal 6 mm

Calza de Neopreno

62263

Pija 6 x 3/4"

19.4
0.766"

8268 PATENTE
ADAPTADOR CURVO
Longitud 6.10 m

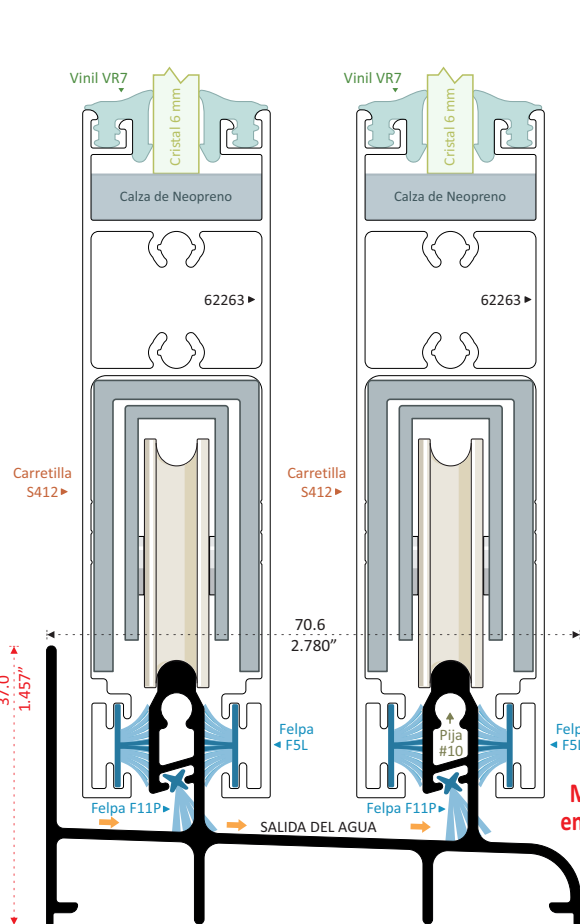

62263 PATENTE
ZOCLO
Y
CABEZAL
Longitud 6.10 m

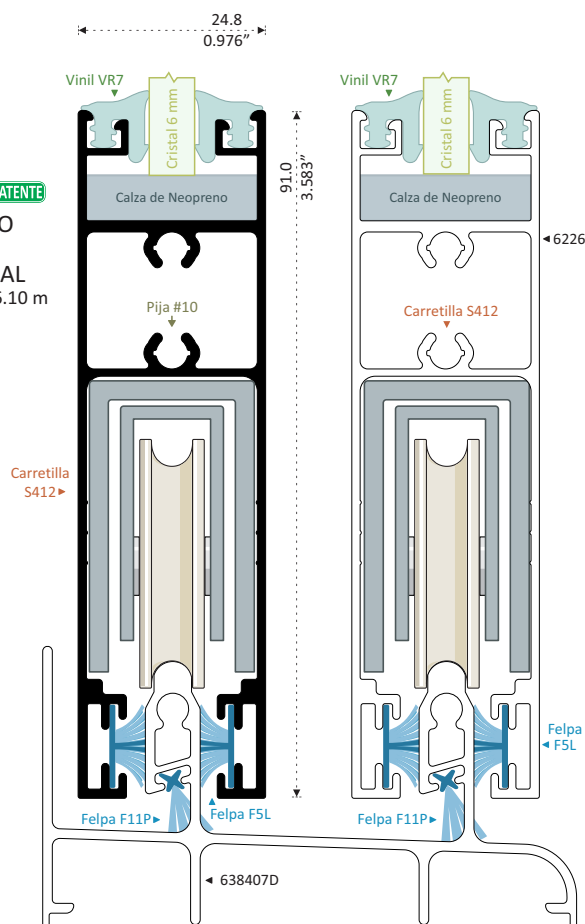

24.8
0.976"

Cristal Biselado

Cruceta CRZ

62263

Carretilla S412

Felpa F5L

Felpa F11P

26.0
1.024"

8267 PATENTE
INTERMEDIO
BISELADO
Longitud 6.10 m

24.8
0.976"

Cristal Biselado

15.7
0.618"

62263

8266 PATENTE
RETÍCULA
PERIMETRAL
Longitud 6.10 m

Alta Permeabilidad al Agua

638407
RIEL Y CABEZAL
Longitud 6.10 m
638407-C 3.05 m

638407D
Longitud 6.10 m

638407D-C
Longitud 3.05 m

Drenes cada 40 cm sin Costo

Mayor Resistencia en Cristales Pesados

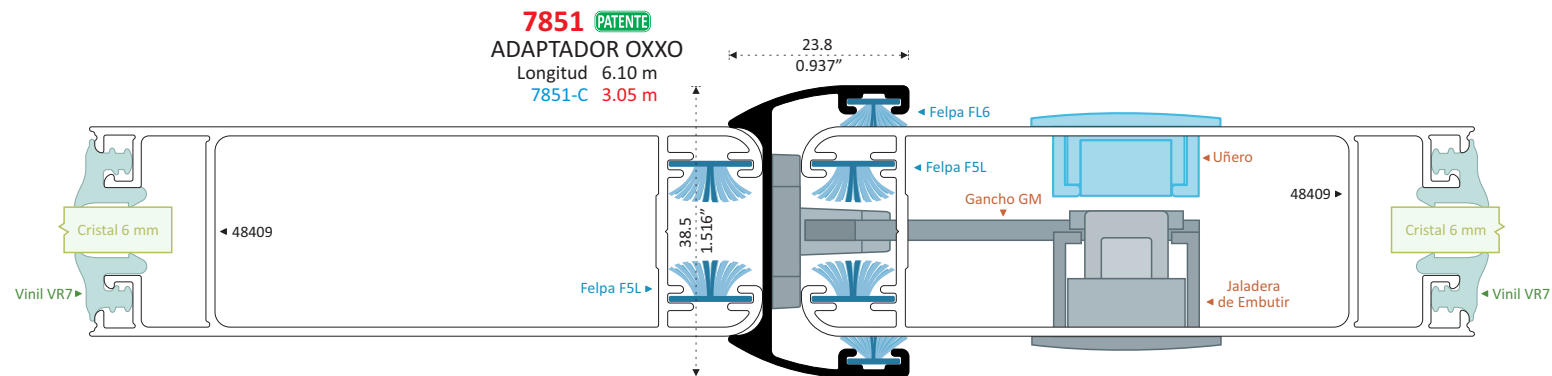
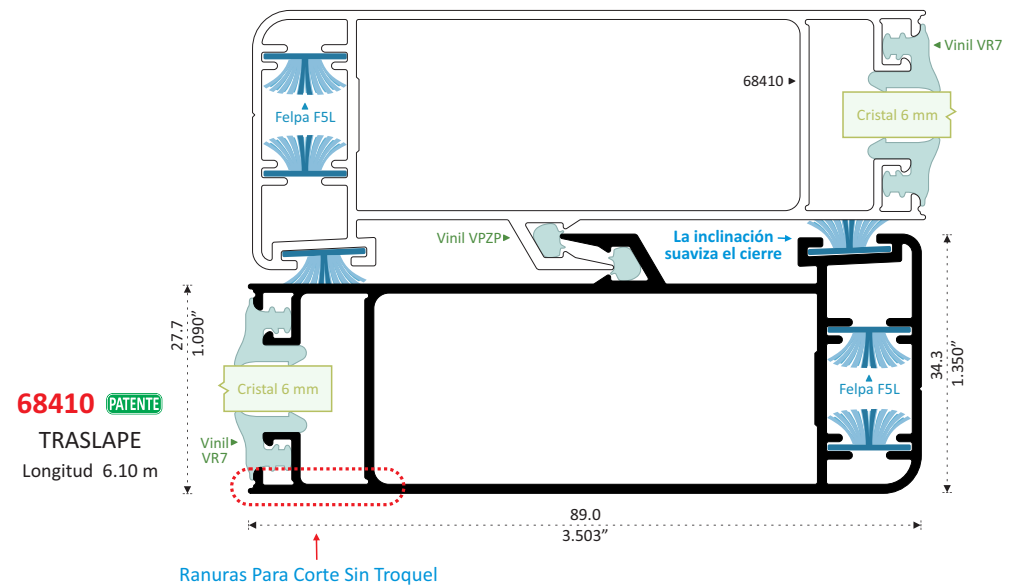
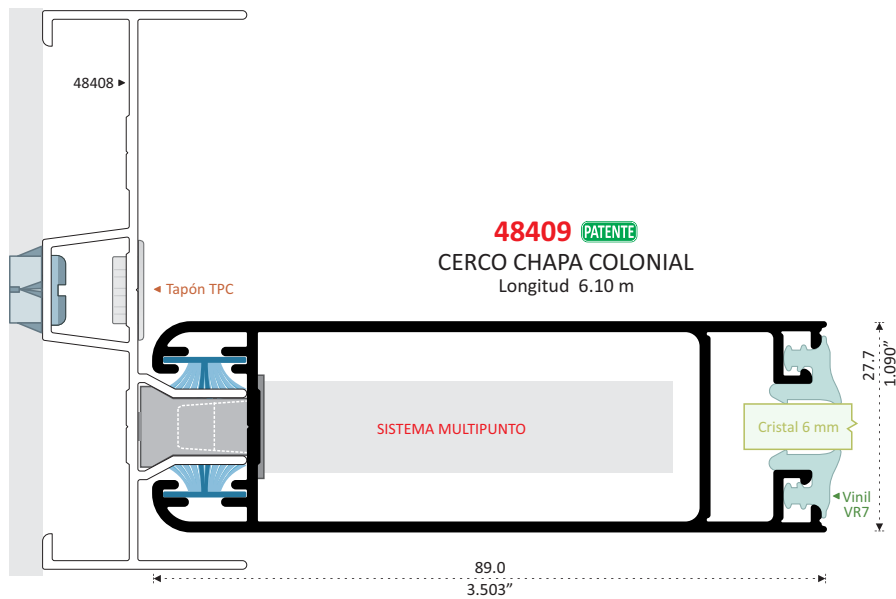
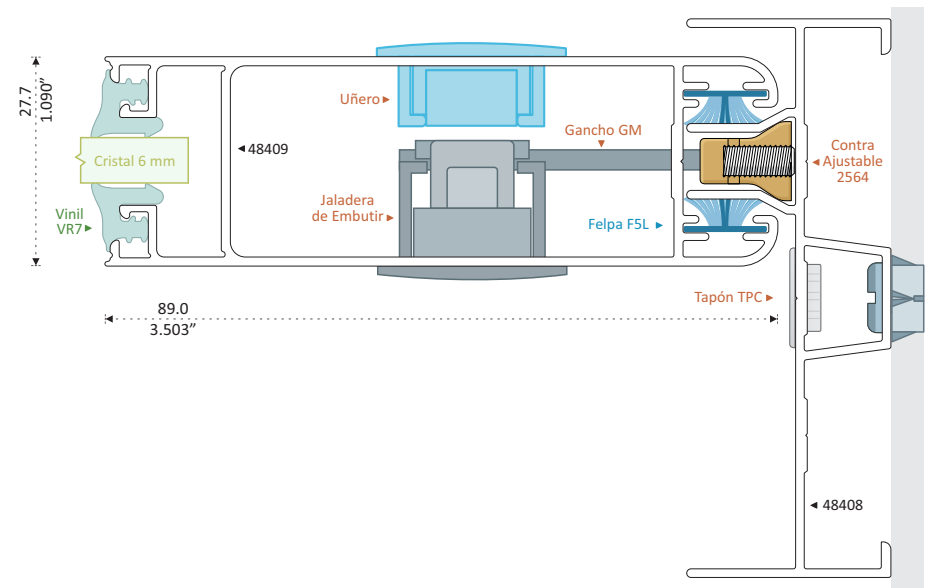
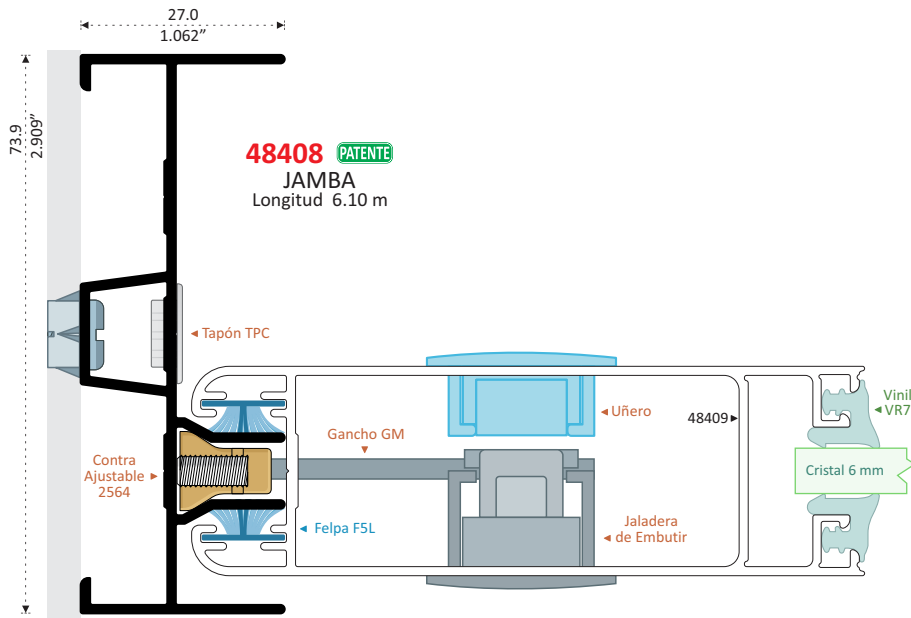

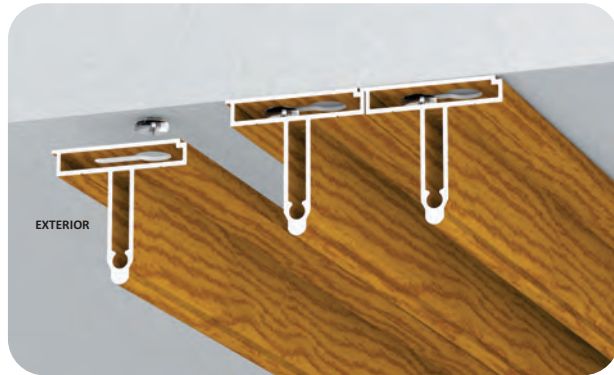

15408
JAMBA SENCILLA
Longitud 6.10 m

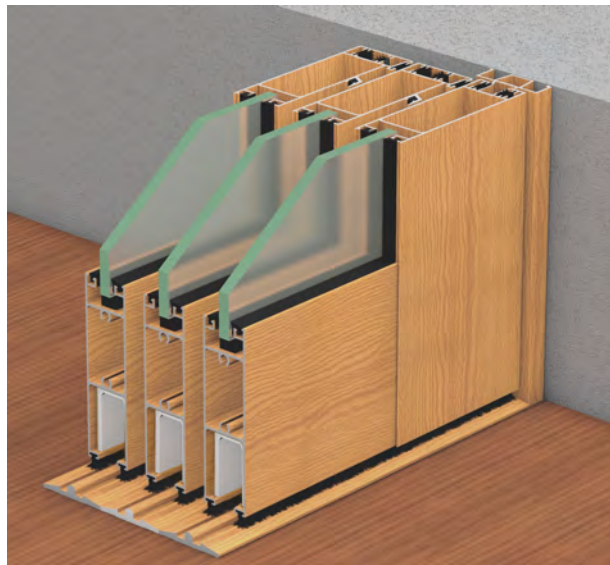
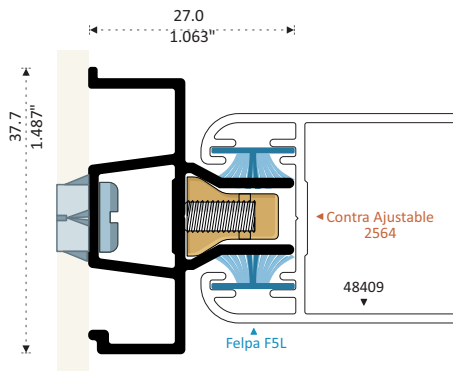

15407
RIEL SENCILLO
Longitud 6.10 m

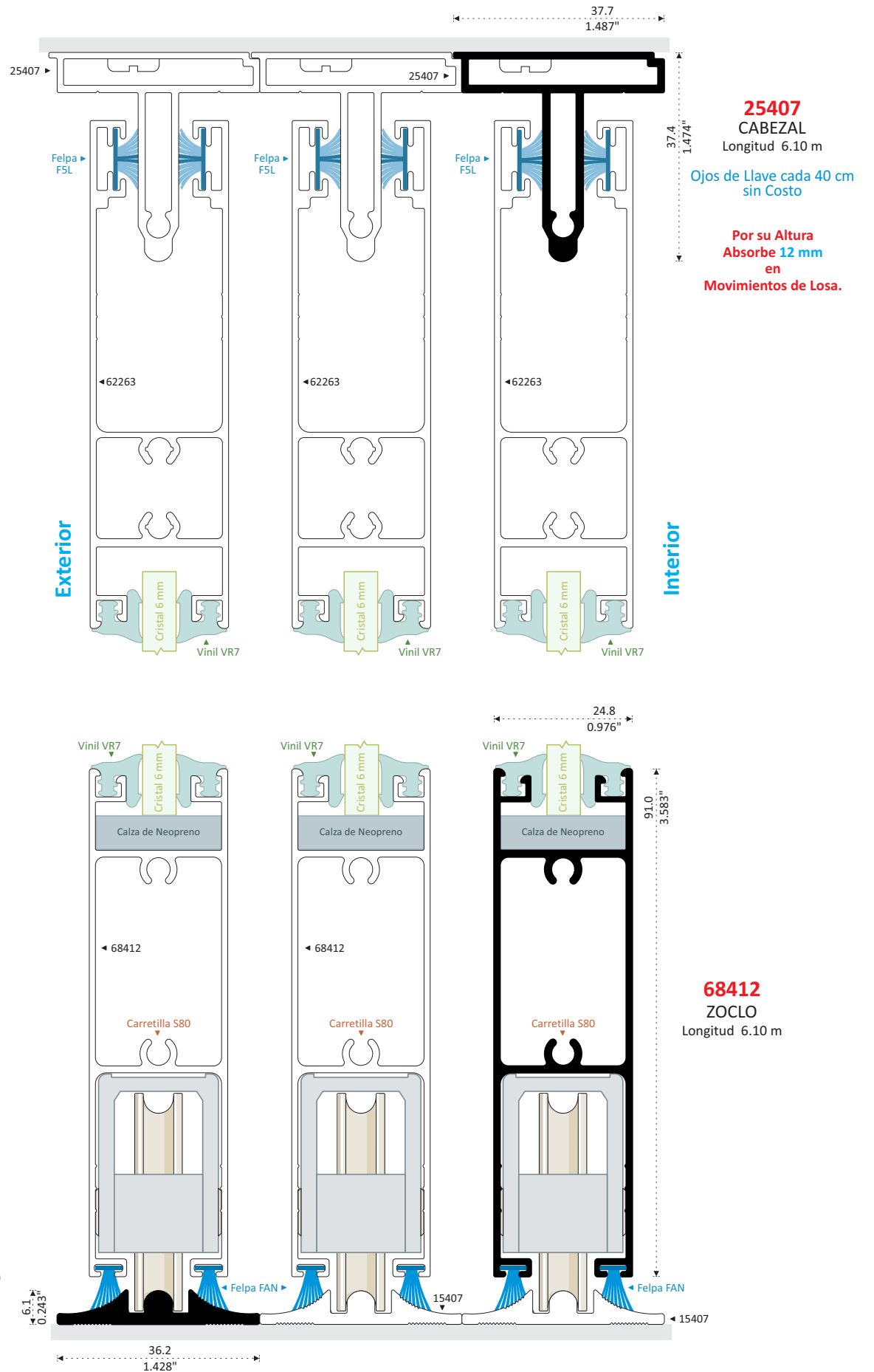

CORREDIZA SERIE 80 VINIL CUÑA

PRUEBAS EN NUESTRO CENTRO DE INVESTIGACIÓN Y DESARROLLO
Armadas con Perfiles y Complementos Esenciales 100% Perfiletto

🔊 AISLAMIENTO ACÚSTICO

REALIZADO CON 120 DECIBELES AL EXTERIOR
MEDIDA 1.00 x 1.00 m

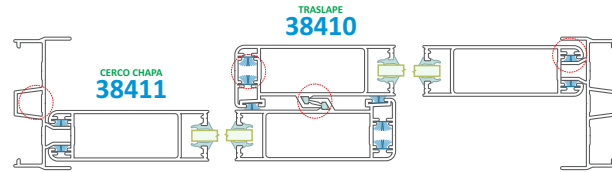

11 mm
5 mm

Felpa F5L
Vinil VPZP
VC11 Ambos lados

AISLAMIENTO
40.7
Decibeles



LÍNEA EXCLUSIVA PERFILETTO

PERMEABILIDAD AL AGUA DURANTE 20 MINUTOS

VENTANA MEDIDA 1.00 x 1.00 m

VELOCIDAD KM/H	Agua	Aire
20	50%	50%
40	50%	50%
60	50%	50%
80	50%	50%
100	50%	50%
120	60%	40%

SIN MOSQUITERO

Sin
Filtraciones

MOSQUITERO CORREDIZO
INTERIOR 11408, 18413 y 11411

Sin
Filtraciones

MOSQUITERO CORREDIZO
EXTERIOR 11408, 18413 y 11411

VELOCIDAD KM/H	Agua	Aire	Litros Filtrados
20	50%	50%	2.52
40	50%	50%	2.86
60	50%	50%	2.91
80	50%	50%	3.20
100	50%	50%	3.29
120	60%	40%	3.38

MOSQUITERO CORREDIZO
EXTERIOR
OCASIONA ALTA FILTRACIÓN
DE AGUA

PUERTA MEDIDA 1.00 x 1.00 m

VELOCIDAD KM/H	Agua	Aire
20	50%	50%
40	50%	50%
60	50%	50%
80	50%	50%
100	50%	50%
120	60%	40%

SIN MOSQUITERO

Sin
Filtraciones

MOSQUITERO CORREDIZO
INTERIOR 11408, 18413 y 11411

Sin
Filtraciones

MOSQUITERO CORREDIZO
EXTERIOR 11408, 18413 y 11411

VELOCIDAD KM/H	Agua	Aire	Litros Filtrados
20	50%	50%	2.57
40	50%	50%	2.92
60	50%	50%	2.96
80	50%	50%	3.25
100	50%	50%	3.33
120	60%	40%	3.42

MOSQUITERO CORREDIZO
EXTERIOR
OCASIONA ALTA FILTRACIÓN
DE AGUA

PERMEABILIDAD AL VIENTO Medida 1.00 x 1.00 m

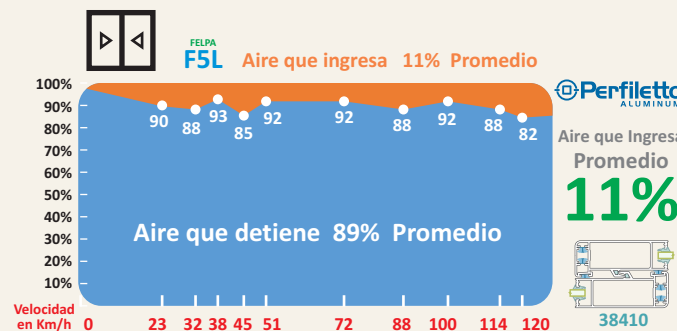
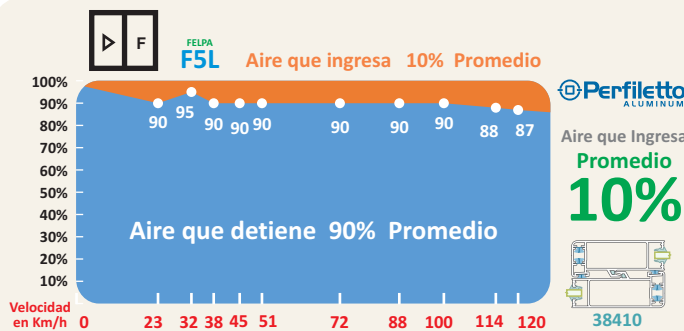

LÍNEA EXCLUSIVA PERFILETTO

RESISTENCIAS A VIENTOS

VENTANA

Prueba Realizada
30 Repeticiones de 1 Minuto c/u
A 120 Km/h
Medida 1.00 x 1.00 m
Cristal 6 mm
LOS PERFILES SIN DEFORMACIÓN
CONSERVAN SU
FUNCIONAMIENTO

PUERTA

Prueba Realizada
30 Repeticiones de 1 Minuto c/u
A 120 Km/h
Medida 2.00 X 2.10 m
Cristal 6 mm
LOS PERFILES SIN DEFORMACIÓN
CONSERVAN SU
FUNCIONAMIENTO

LÍNEA SERIE 80 VINIL CUÑA

Convierte un Producto Perfiletto En Extraordinario



Riel Doble Guía
Opcional
Dos Hojas Móviles



Mejor Salida de Agua por:
- Riel con Pared Interior Alta
- Inclinación de Riel
- Drenes Inferiores

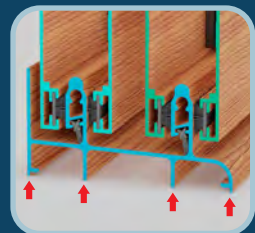

Resistencia de
4 Puntos de Apoyo
para Cristales Pesados



Mayor Hermeticidad
por Doble Felpa entre
Zoclo y Riel

Mayor Hermeticidad por Rozamiento de Felpas F5L con Labios Textiles



2 Felpas Horizontales
en Zoclo



Vista Real



2 Felpas Verticales
en Traslapes



Zoclo Entra Hasta el Fondo de
Cerco Chapa y Traslape

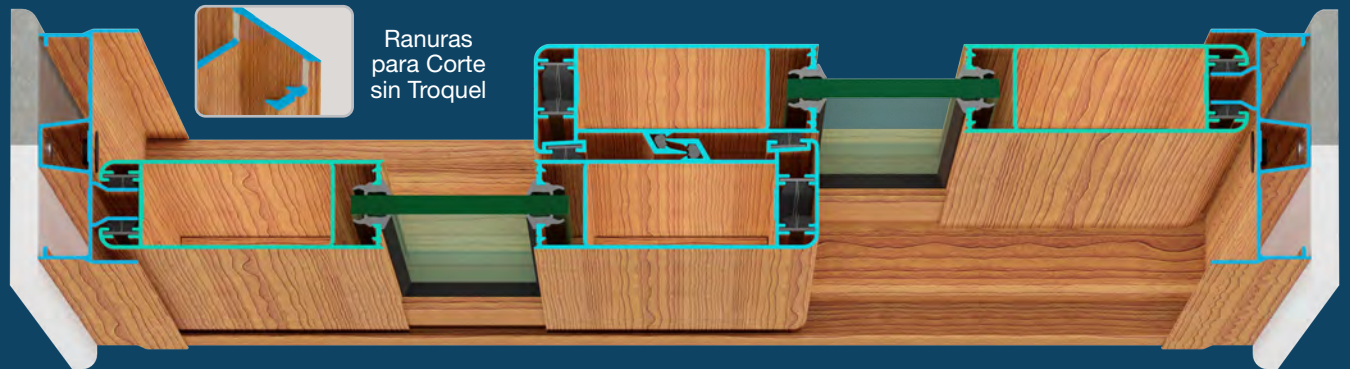

Ranuras
para Corte
sin Troquel



Doble Vinil Cuña
Aumenta
Aislamiento Acústico

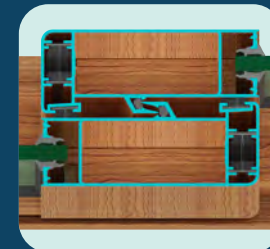

Hermeticidad entre Traslapes
por 2 Vinilos VPZP y 6 Felpas



Vistas Curvas y
Cierre Suave por sus Felpas

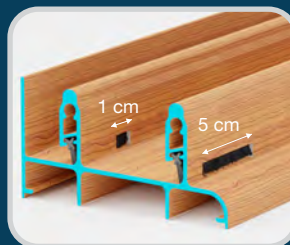

Aumentan la Hermeticidad:
- Aislamiento Acústico
- Resistencia a Viento
- Filtra Polvo
- Salida de Agua
- Impide Entrada de Insectos

Riel Inferior
Incluye Drenes cada 40 cm
Colocar Felpa F11P

Descubre otras Opciones para tu Cancelería



Mosquetero Interior
Riel Triple



Doble Cristal de 6 mm
con Separador de 3/16"
Vinil en Ambos Lados

■ Aislamiento Acústico Con 38410 40.7 Decibles

■ Permeabilidad a Viento y Polvo Aire que Detiene 89 %

■ Resistencia A Vientos Sin Deformar el Perfil Ventana 120 Km/h Puerta 120 Km/h

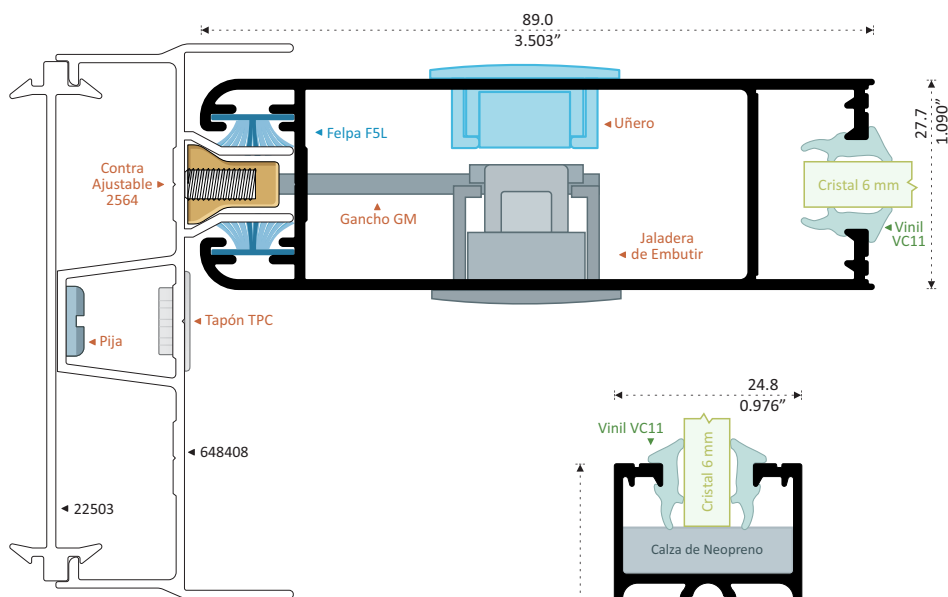
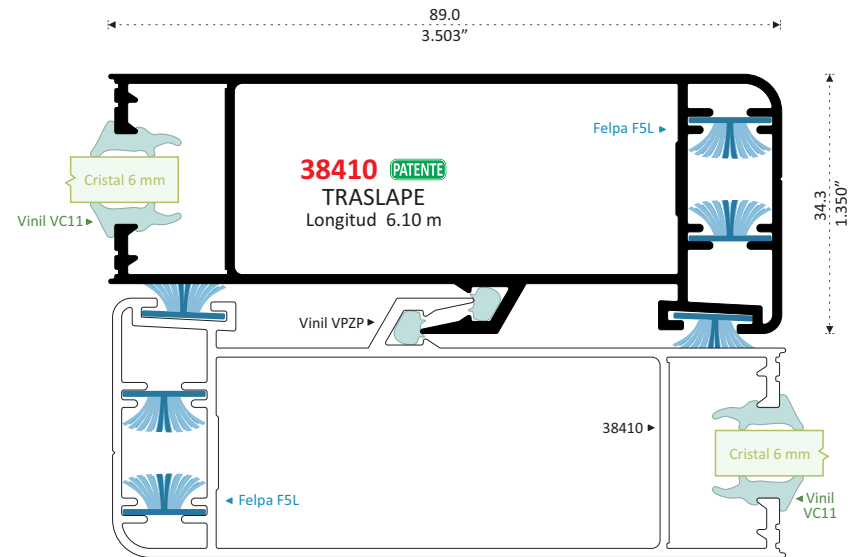
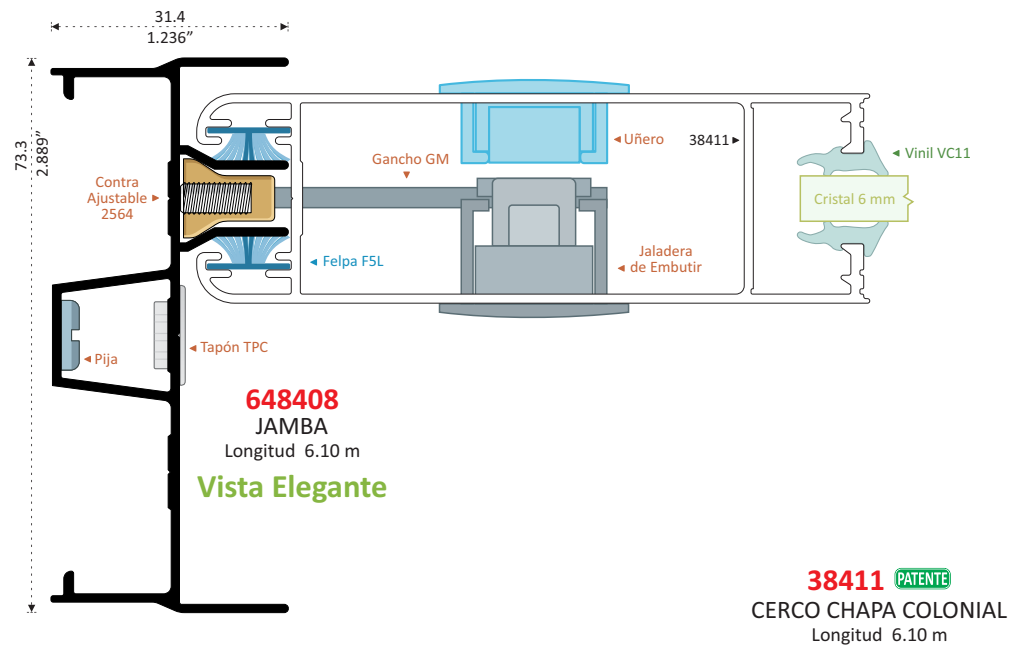

Ensambla con Línea Fija



Ensamble Directo al Riel

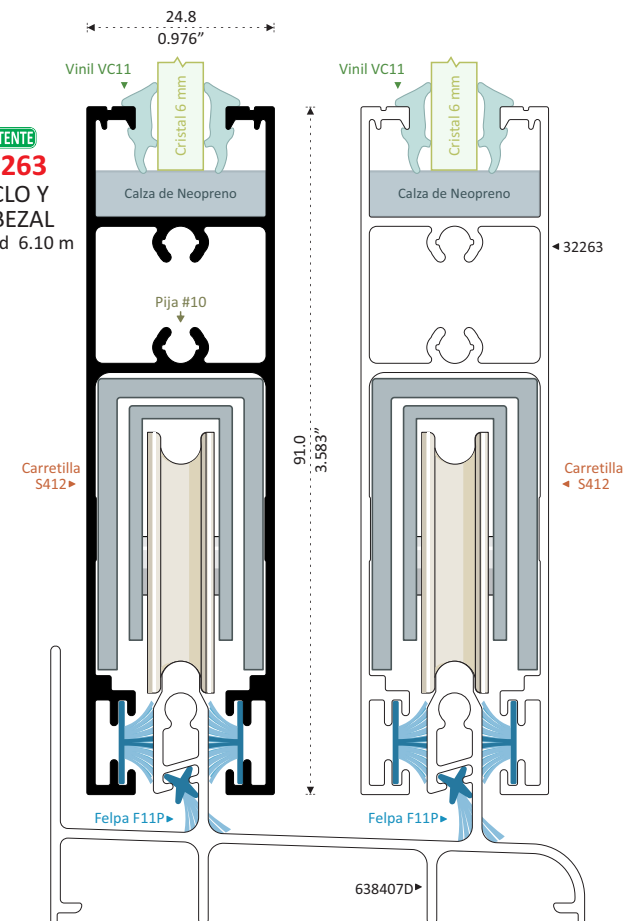
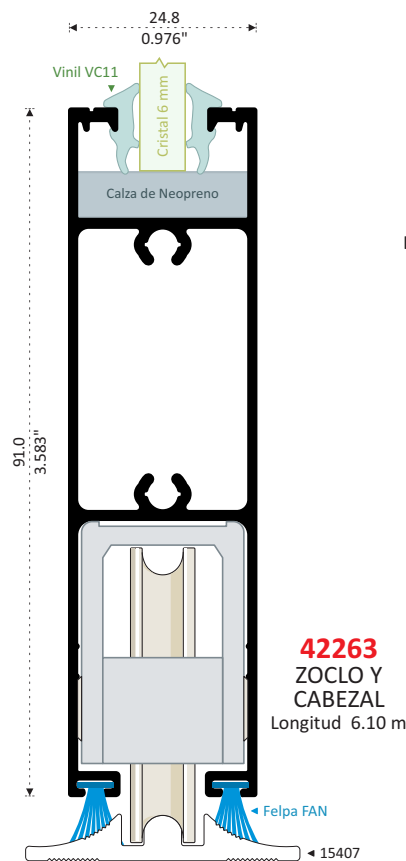
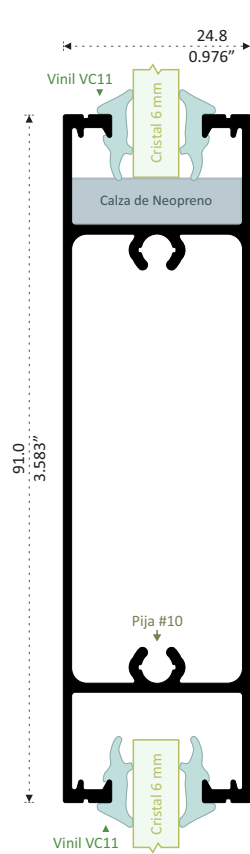

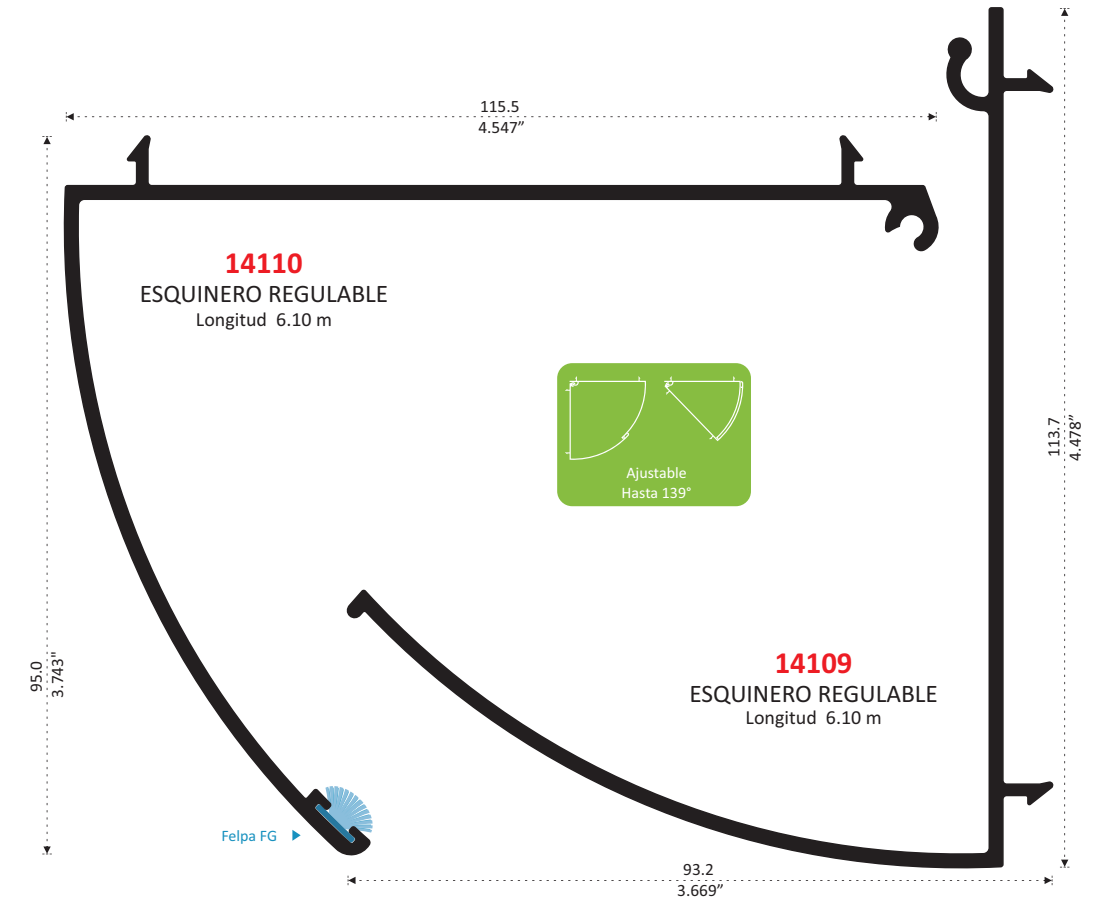
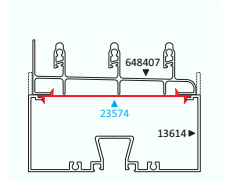
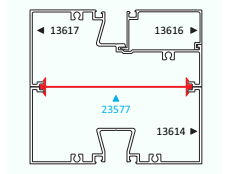
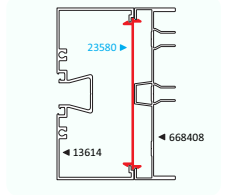
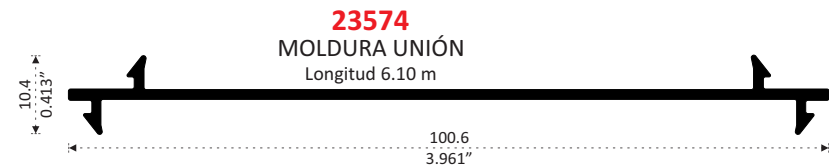
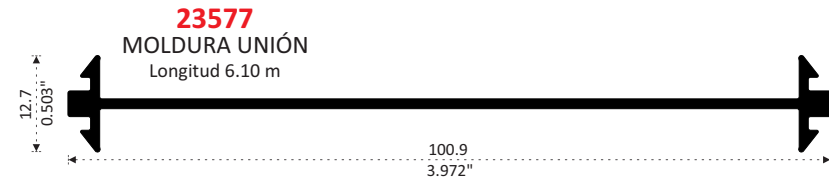
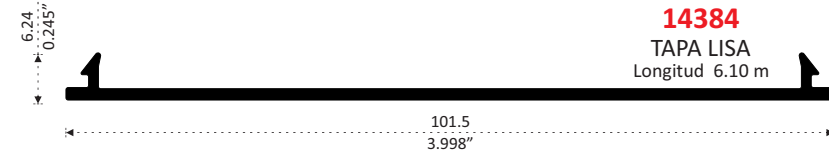
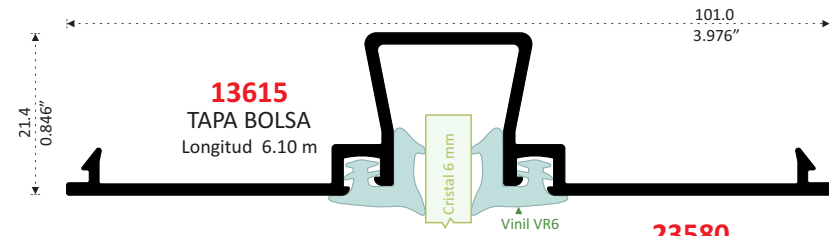
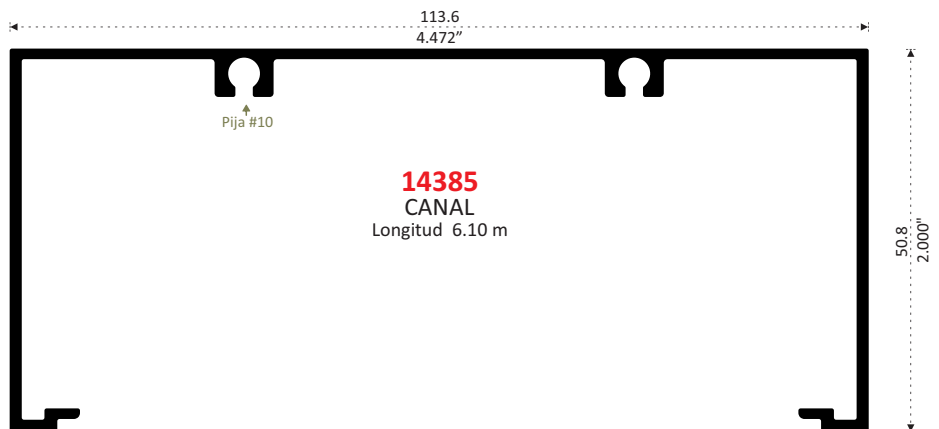
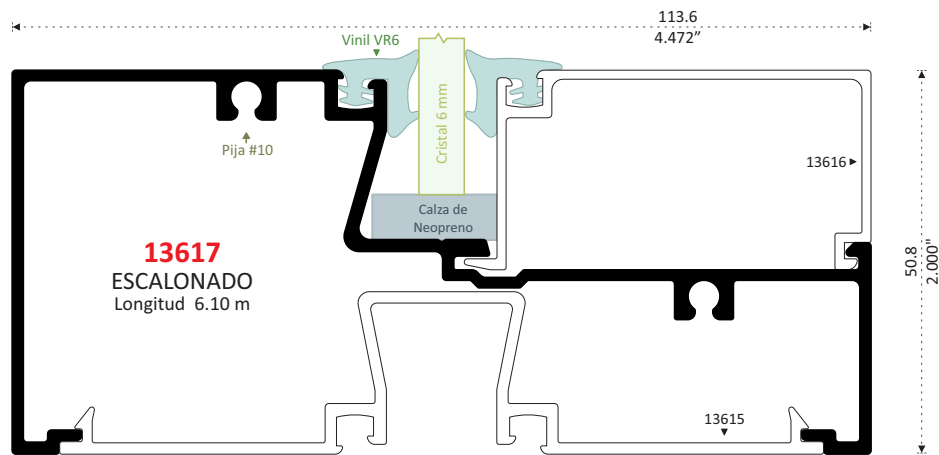
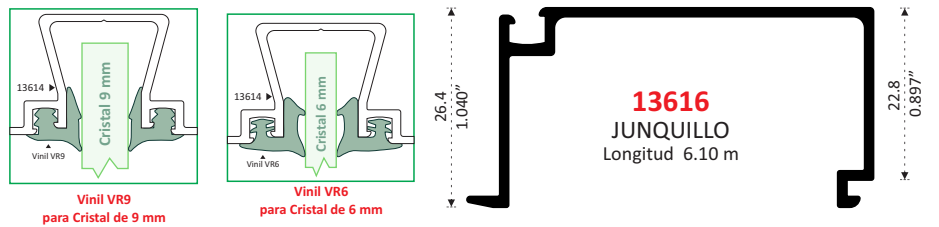
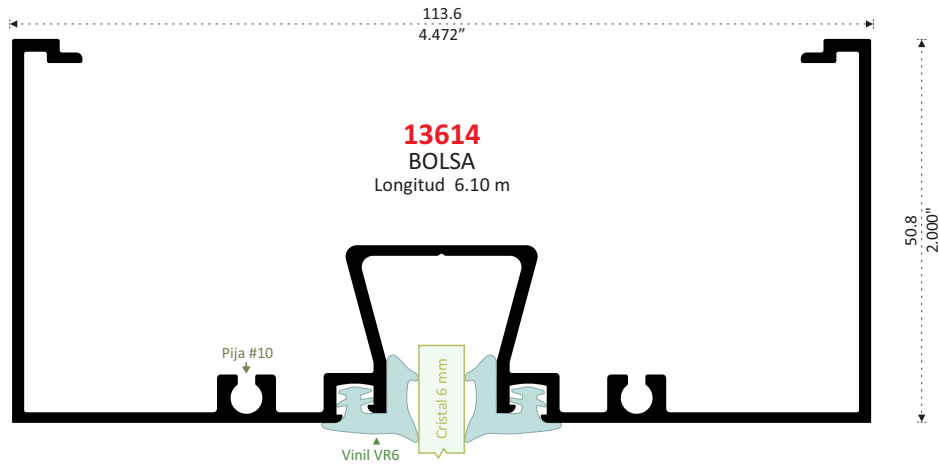
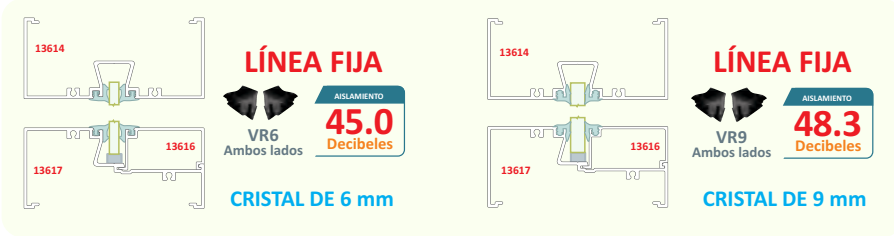

AISLAMIENTO ACÚSTICO
 REALIZADO CON 120 DECIBELES AL EXTERIOR
 MEDIDA 1.00 x 1.00 m

VINIL RESPALDO 

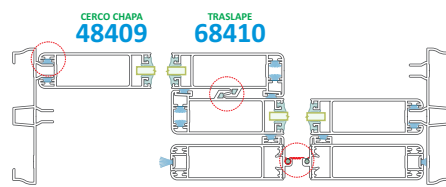

11 mm
5 mm

Felpa F5L Vinil VPZP VR7 Ambos lados

AISLAMIENTO
 39.0
 Decibeles

VINIL CUÑA 



11 mm
5 mm

Felpa F5L Vinil VPZP VC11 Ambos lados

AISLAMIENTO
 38.9
 Decibeles

LÍNEA EXCLUSIVA PERFILETTO

LÍNEA EXCLUSIVA PERFILETTO

PERMEABILIDAD AL AGUA DURANTE 20 MINUTOS

VENTANA MEDIDA 1.00 x 1.00 m

VELOCIDAD KM/H	Agua	Aire
20	50%	50%
40	50%	50%
60	50%	50%
80	50%	50%
100	50%	50%
120	60%	40%

SIN MOSQUITERO
 Sin
 Filtraciones

MOSQUITERO CORREDIZO INTERIOR
 Sin
 Filtraciones

MOSQUITERO CORREDIZO EXTERIOR

VELOCIDAD KM/H	Agua	Aire	Litros Filtrados
20	50%	50%	6.88
40	50%	50%	9.63
60	50%	50%	11.29
80	50%	50%	11.92
100	50%	50%	12.90
120	60%	40%	13.44

MOSQUITERO CORREDIZO EXTERIOR
 OCASIONA ALTA FILTRACIÓN DE AGUA

PUERTA MEDIDA 1.00 x 1.00 m

VELOCIDAD KM/H	Agua	Aire
20	50%	50%
40	50%	50%
60	50%	50%
80	50%	50%
100	50%	50%
120	60%	40%

SIN MOSQUITERO
 Sin
 Filtraciones

MOSQUITERO CORREDIZO INTERIOR
 Sin
 Filtraciones

MOSQUITERO CORREDIZO EXTERIOR

VELOCIDAD KM/H	Agua	Aire	Litros Filtrados
20	50%	50%	7.00
40	50%	50%	9.70
60	50%	50%	11.35
80	50%	50%	12.00
100	50%	50%	13.08
120	60%	40%	13.65

MOSQUITERO CORREDIZO EXTERIOR
 OCASIONA ALTA FILTRACIÓN DE AGUA

PERMEABILIDAD AL VIENTO Medida 1.00 x 1.00 m

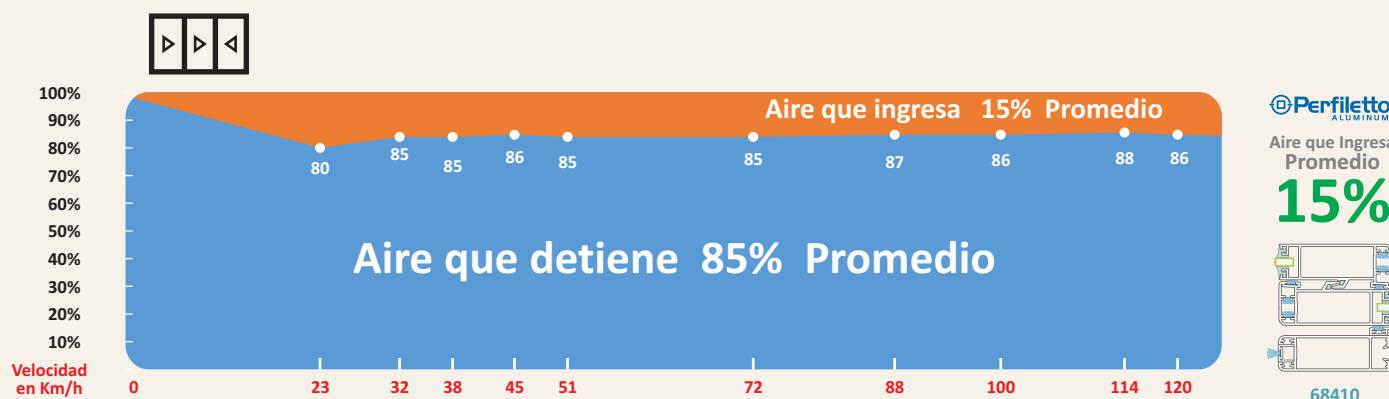

LÍNEA EXCLUSIVA PERFILETTO

RESISTENCIAS A VIENTOS

VENTANA

Prueba Realizada
 30 Repeticiones de 1 Minuto c/u
 A 120 Km/h
 Medida 1.00 x 1.00 m
 Cristal 6 mm

LOS PERFILES SIN DEFORMACIÓN CONSERVAN SU FUNCIONAMIENTO

PUERTA

Prueba Realizada
 30 Repeticiones de 1 Minuto c/u
 A 120 Km/h
 Medida 2.00 X 2.10 m
 Cristal 6 mm

LOS PERFILES SIN DEFORMACIÓN CONSERVAN SU FUNCIONAMIENTO

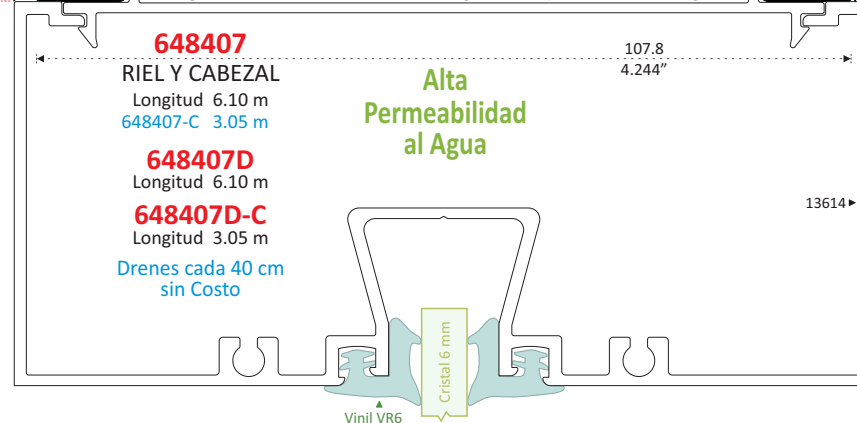
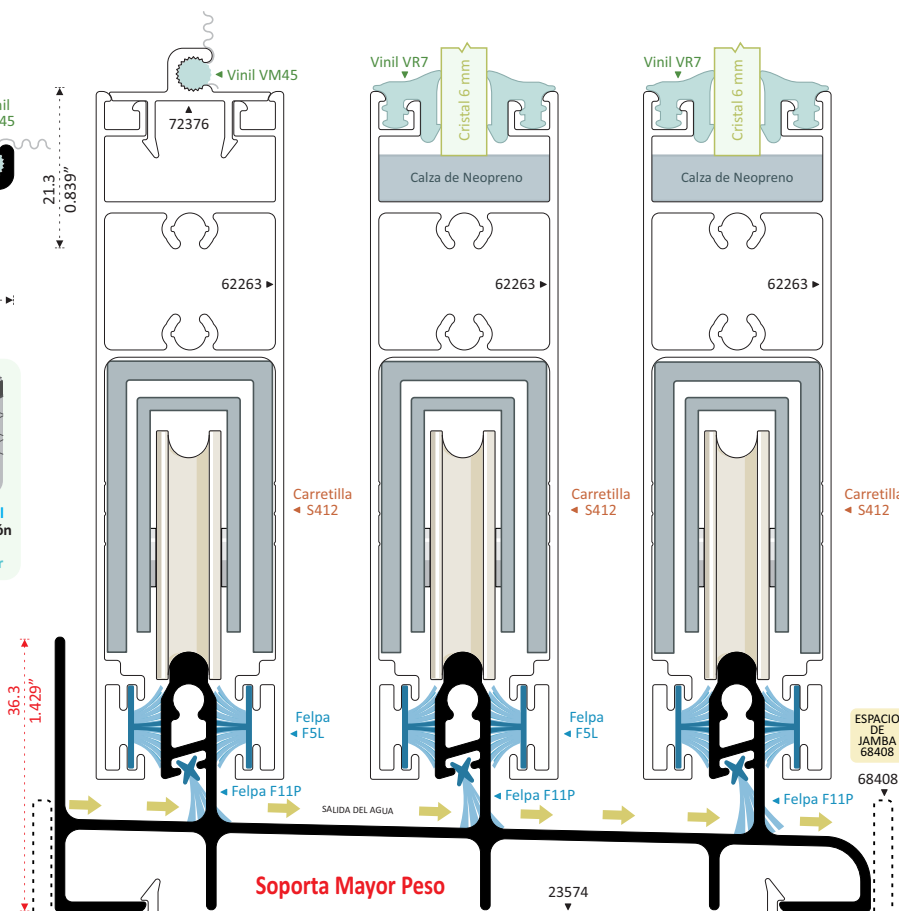
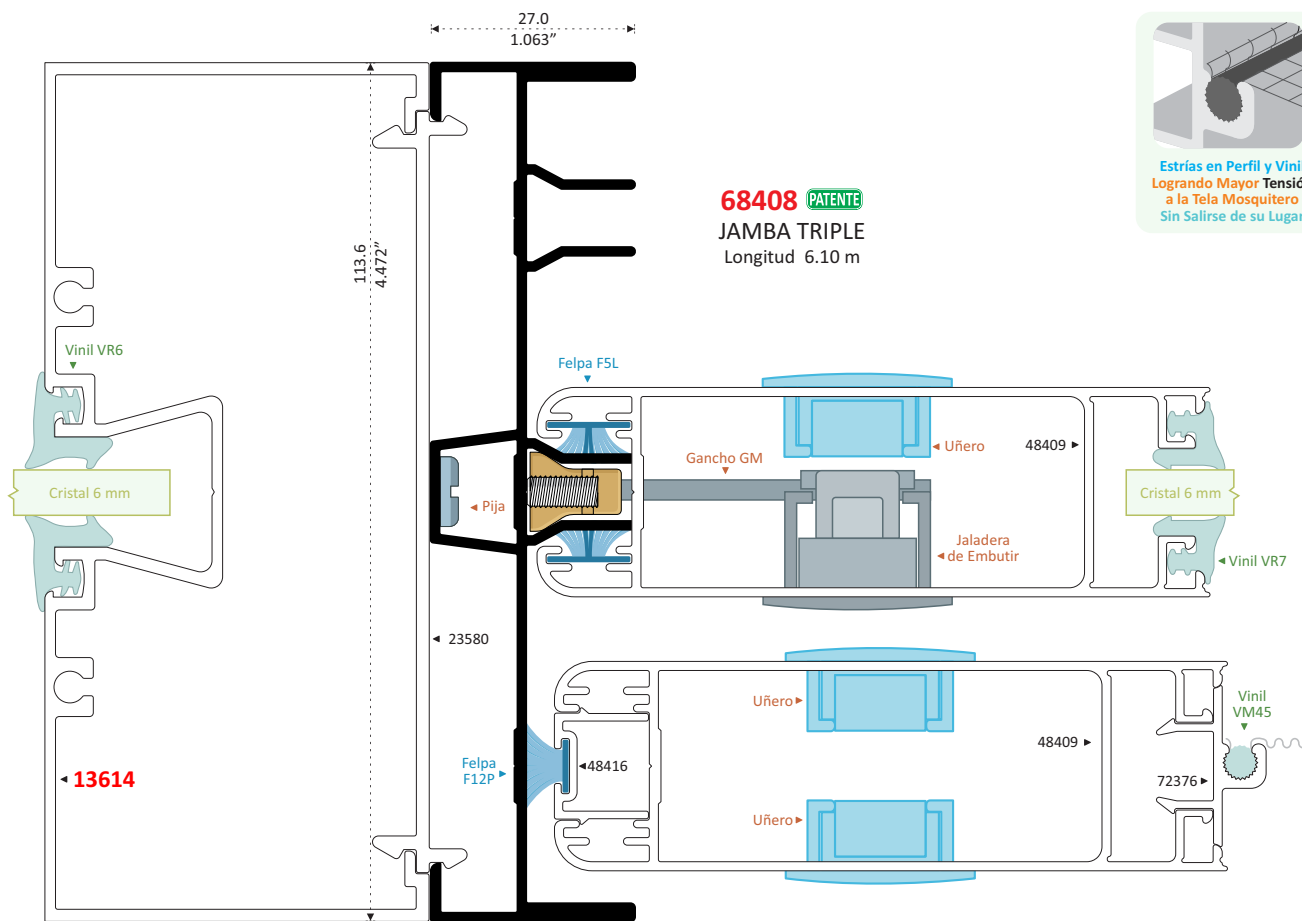
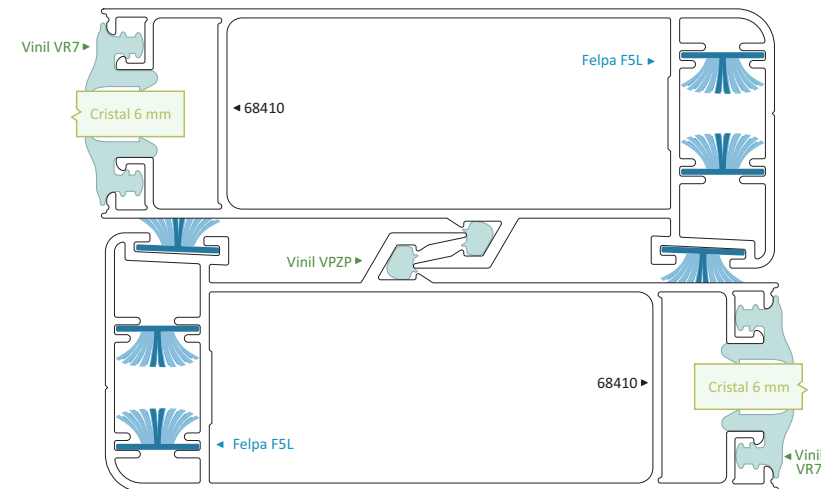
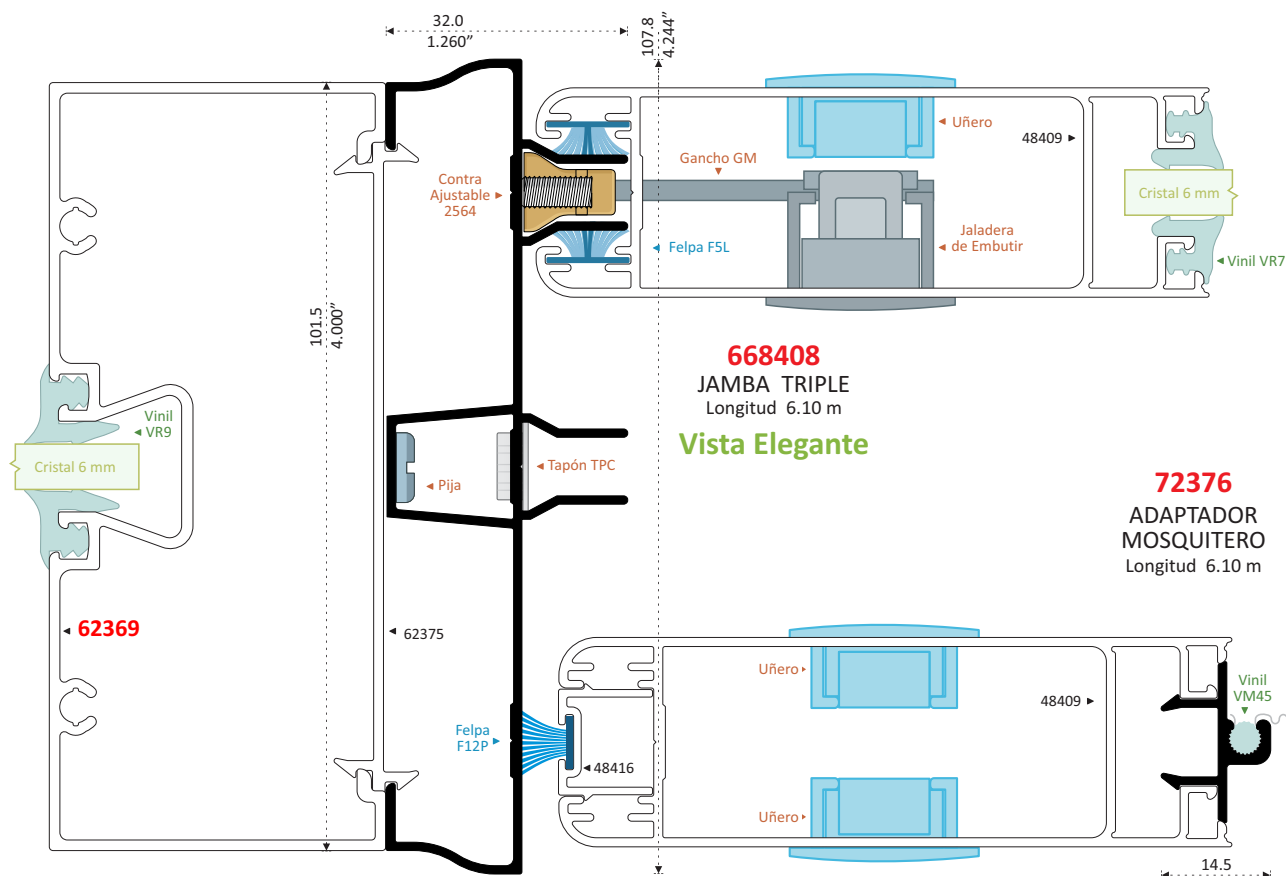

648407
RIEL Y CABEZAL
Longitud 6.10 m
648407-C 3.05 m
648407D
Longitud 6.10 m
648407D-C
Longitud 3.05 m
Drenes cada 40 cm
sin Costo

Alta Permeabilidad al Agua

ESPACIO DE JAMBA 68408

Aumenta la Hermeticidad Acústica, Colocando Vinil por Ambos Lados

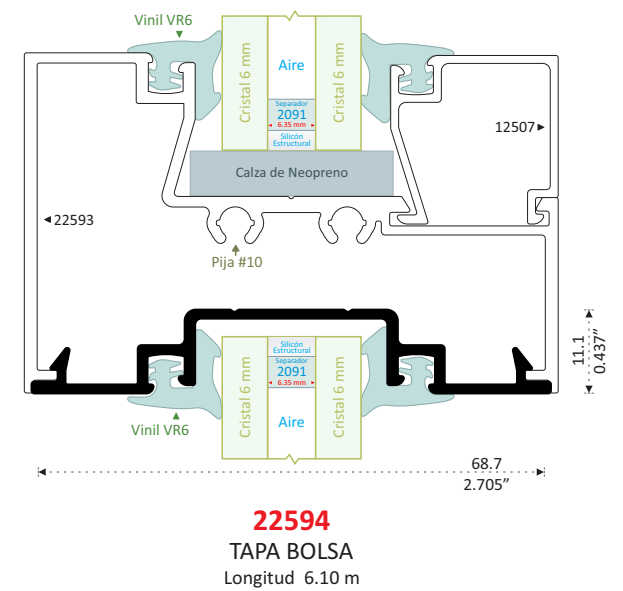
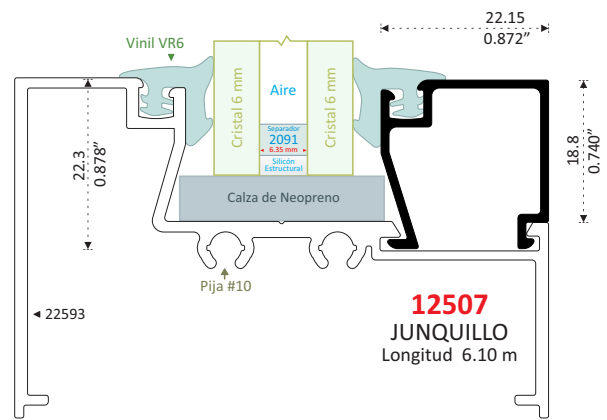
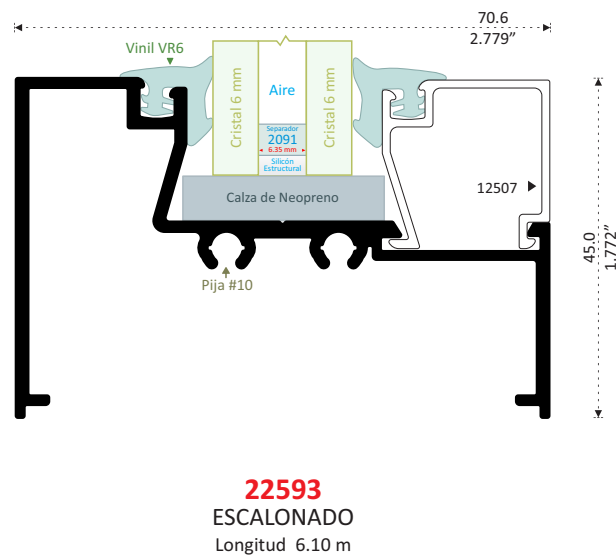
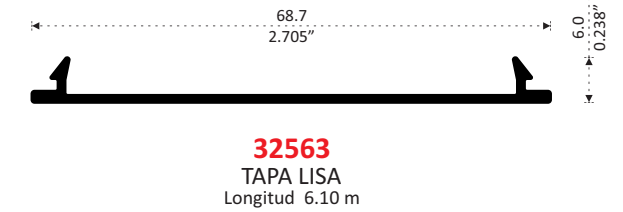
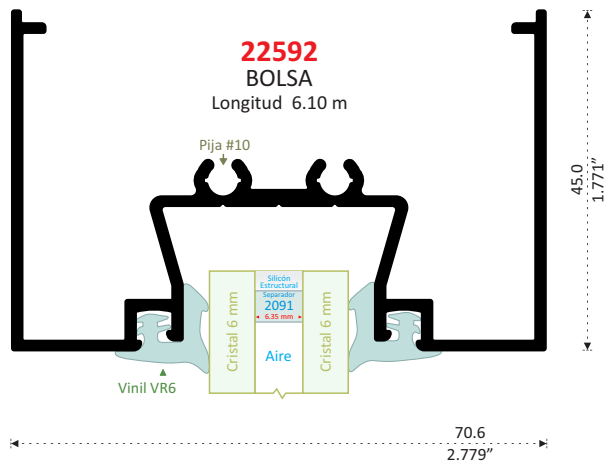
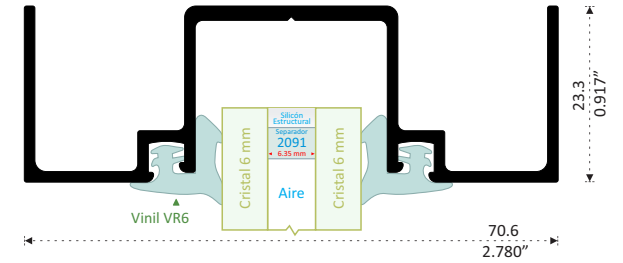
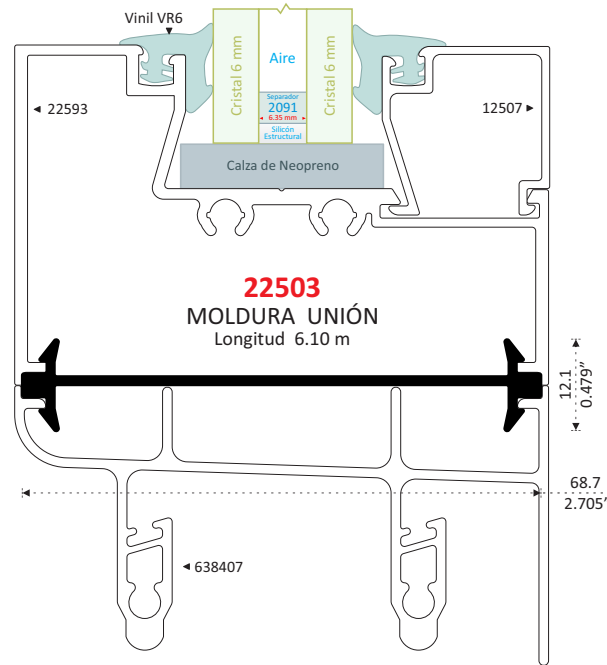
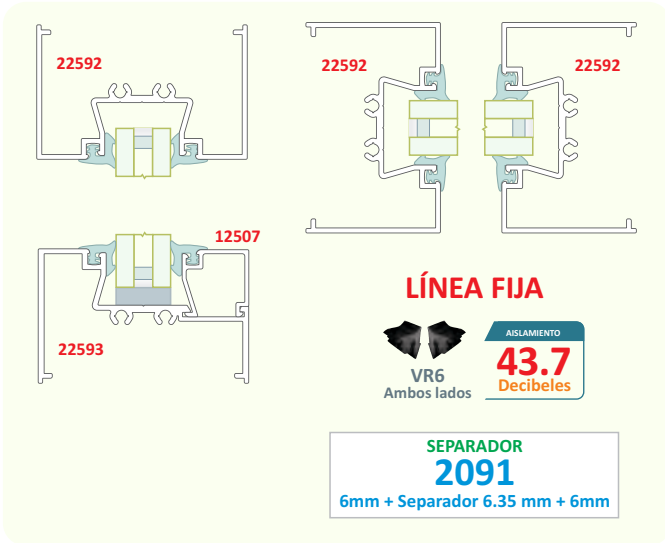

Aumenta la Hermeticidad Acústica, Colocando Vinil por Ambos Lados

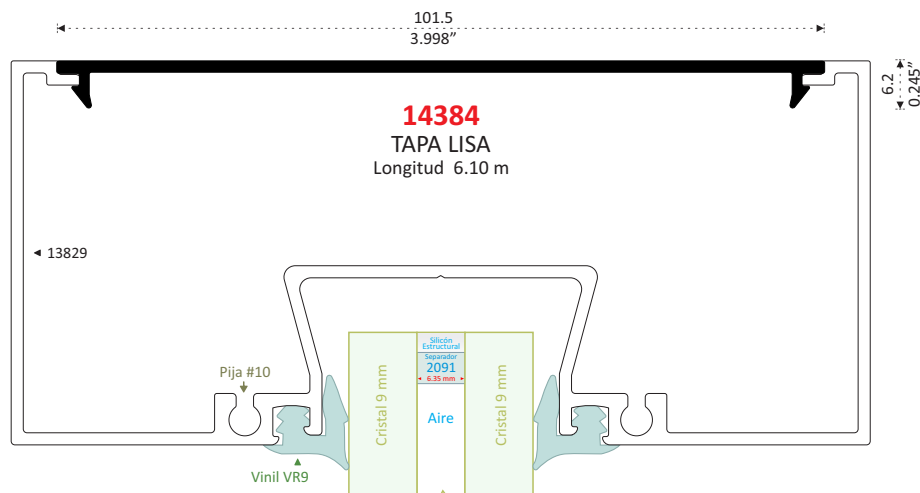
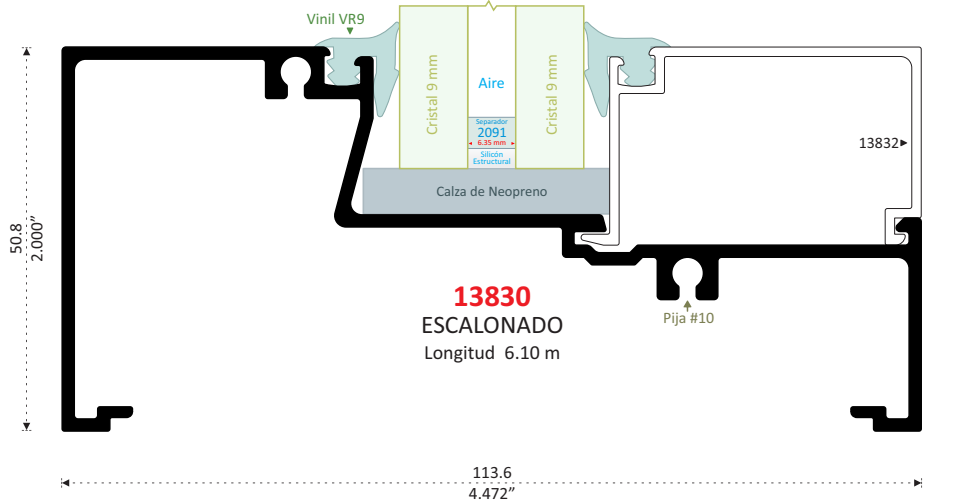
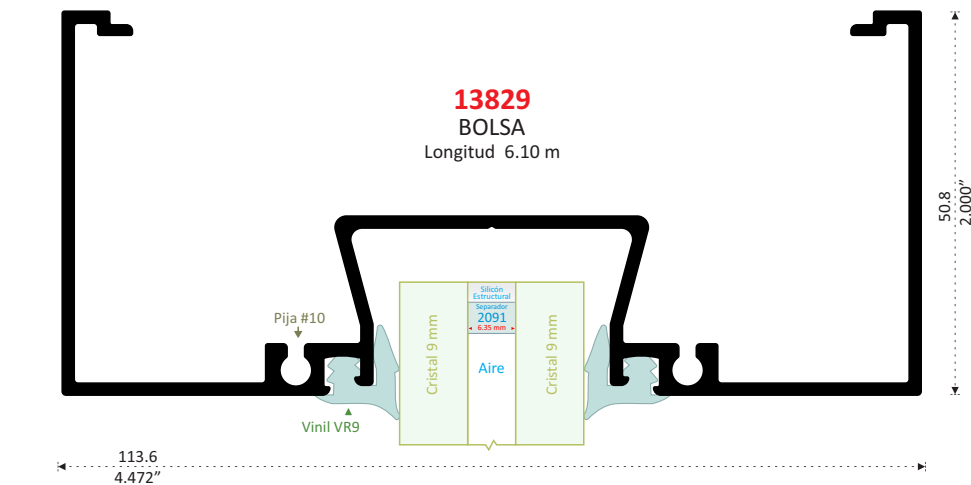
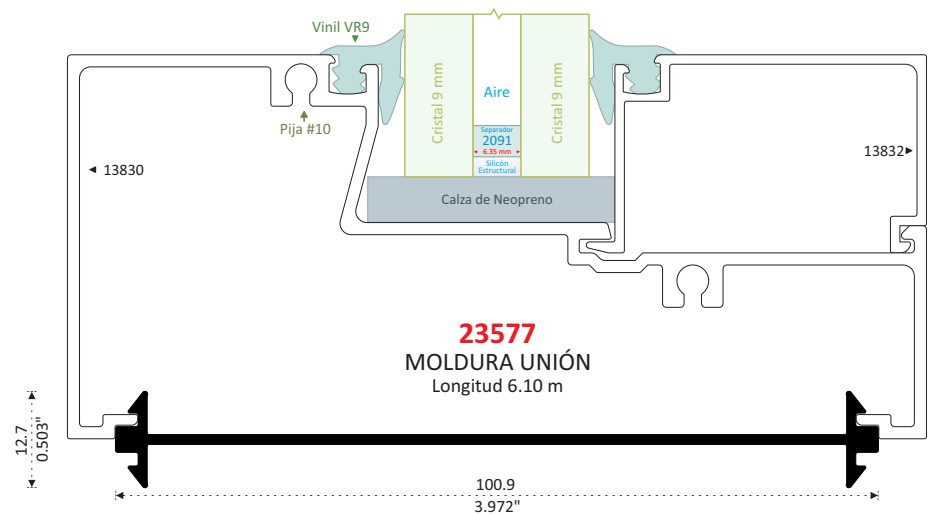
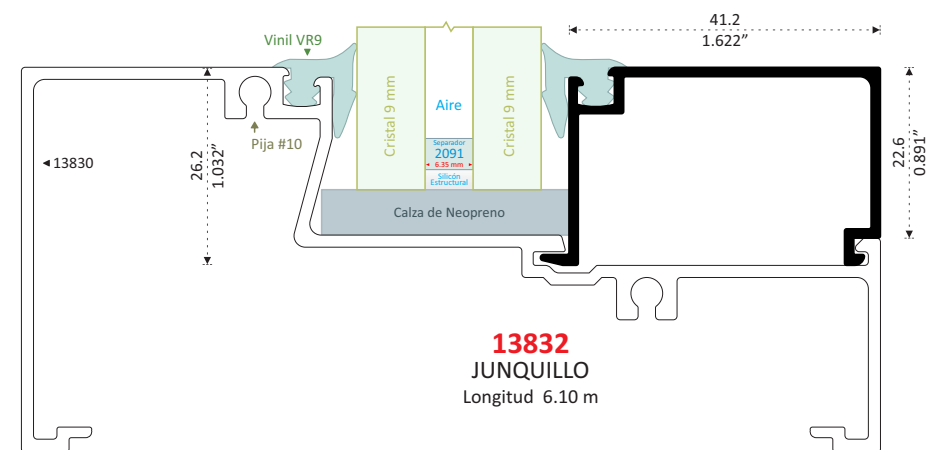
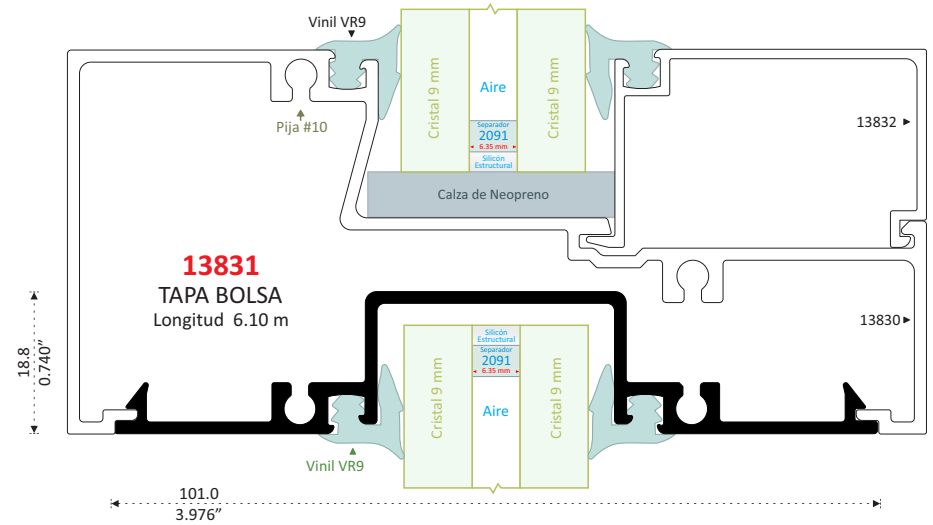
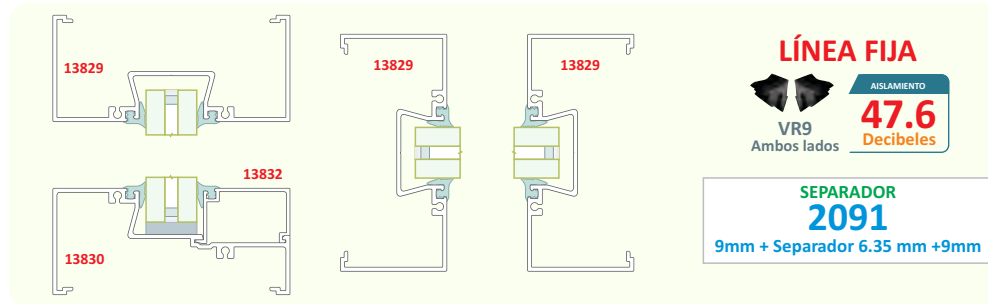

CORREDIZA SERIE 80 CRISTAL DOBLE

PRUEBAS EN NUESTRO CENTRO DE INVESTIGACIÓN Y DESARROLLO
Armadas con Perfiles y Complementos Esenciales 100% Perfiletto

ASLAMIENTO ACÚSTICO
REALIZADO CON 120 DECIBELES AL EXTERIOR
MEDIDA 1.00 x 1.00 m

SEPARADOR
3106
6mm + Separador 4.7 mm + 6mm

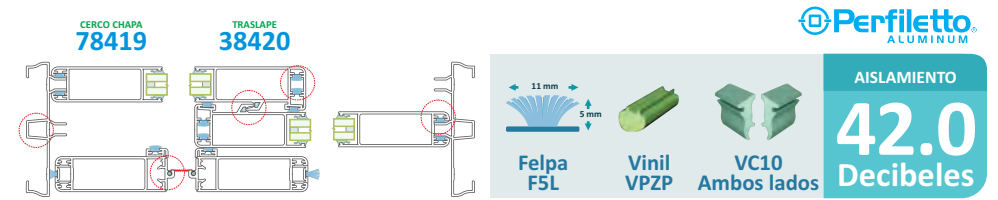
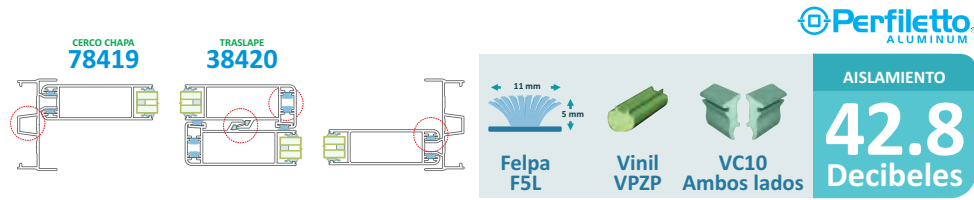

LÍNEA EXCLUSIVA PERFILETTO

LÍNEA EXCLUSIVA PERFILETTO

PERMEABILIDAD AL AGUA

DURANTE 20 MINUTOS

▶◀ **VENTANA MEDIDA 1.00 x 1.00 m**

VELOCIDAD KM/H	Agua	Aire
20	50%	50%
40	50%	50%
60	50%	50%
80	50%	50%
100	50%	50%
120	60%	40%

SIN MOSQUITERO
Sin Filtraciones

MOSQUITERO CORREDIZO EXTERIOR 11408, 18413 y 11411
Sin Filtraciones

MOSQUITERO CORREDIZO EXTERIOR 11408, 18413 y 11411

VELOCIDAD KM/H	Agua	Aire	Litros Filtrados
20	50%	50%	2.48
40	50%	50%	2.82
60	50%	50%	2.88
80	50%	50%	3.15
100	50%	50%	3.20
120	60%	40%	3.32

MOSQUITERO CORREDIZO EXTERIOR OCASIONA ALTA FILTRACIÓN DE AGUA

▶◀ **PUERTA MEDIDA 1.00 x 1.00 m**

VELOCIDAD KM/H	Agua	Aire
20	50%	50%
40	50%	50%
60	50%	50%
80	50%	50%
100	50%	50%
120	60%	40%

SIN MOSQUITERO
Sin Filtraciones

MOSQUITERO CORREDIZO EXTERIOR 11408, 18413 y 11411
Sin Filtraciones

MOSQUITERO CORREDIZO EXTERIOR 11408, 18413 y 11411

VELOCIDAD KM/H	Agua	Aire	Litros Filtrados
20	50%	50%	2.53
40	50%	50%	2.87
60	50%	50%	2.92
80	50%	50%	3.20
100	50%	50%	3.29
120	60%	40%	3.37

MOSQUITERO CORREDIZO EXTERIOR OCASIONA ALTA FILTRACIÓN DE AGUA

▶▶◀ **VENTANA MEDIDA 1.00 x 1.00 m**

VELOCIDAD KM/H	Agua	Aire
20	50%	50%
40	50%	50%
60	50%	50%
80	50%	50%
100	50%	50%
120	60%	40%

SIN MOSQUITERO
Sin Filtraciones

MOSQUITERO CORREDIZO INTERIOR
Sin Filtraciones

MOSQUITERO CORREDIZO EXTERIOR

VELOCIDAD KM/H	Agua	Aire	Litros Filtrados
20	50%	50%	2.52
40	50%	50%	2.89
60	50%	50%	2.90
80	50%	50%	3.21
100	50%	50%	3.29
120	60%	40%	3.38

MOSQUITERO CORREDIZO EXTERIOR OCASIONA ALTA FILTRACIÓN DE AGUA

▶▶◀ **PUERTA MEDIDA 1.00 x 1.00 m**

VELOCIDAD KM/H	Agua	Aire
20	50%	50%
40	50%	50%
60	50%	50%
80	50%	50%
100	50%	50%
120	60%	40%

SIN MOSQUITERO
Sin Filtraciones

MOSQUITERO CORREDIZO INTERIOR
Sin Filtraciones

MOSQUITERO CORREDIZO EXTERIOR

VELOCIDAD KM/H	Agua	Aire	Litros Filtrados
20	50%	50%	6.90
40	50%	50%	9.58
60	50%	50%	11.15
80	50%	50%	11.95
100	50%	50%	13.00
120	60%	40%	13.58

MOSQUITERO CORREDIZO EXTERIOR OCASIONA ALTA FILTRACIÓN DE AGUA

PERMEABILIDAD AL VIENTO Medida 1.00 x 1.00 m

RESISTENCIAS A VIENTOS

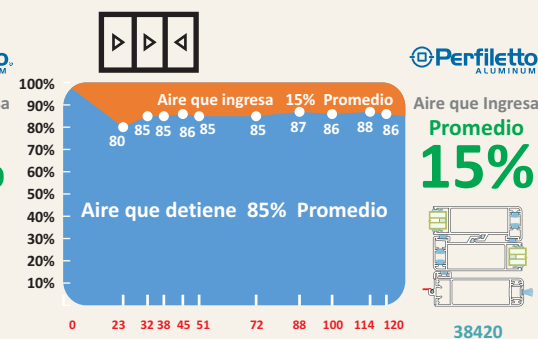
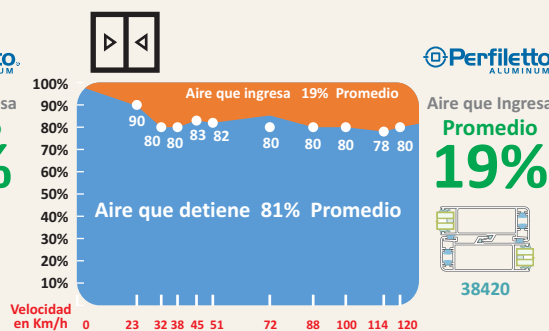
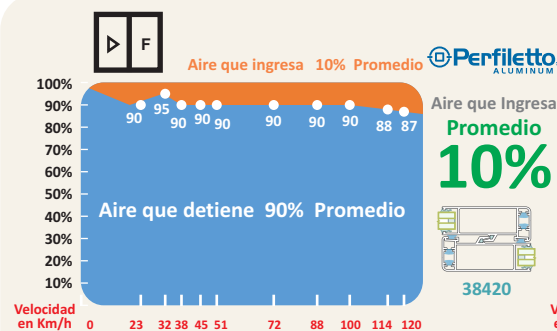

LÍNEA EXCLUSIVA PERFILETTO

VENTANA

Prueba Realizada
30 Repeticiones de 1 Minuto c/u
A 120 Km/h
Medida 1.00 x 1.00 m
Dos Cristales 6 mm
LOS PERFILES SIN DEFORMACIÓN
CONSERVAN SU FUNCIONAMIENTO

PUERTA

Prueba Realizada
30 Repeticiones de 1 Minuto c/u
A 120 Km/h
Medida 2.00 X 2.10 m
Dos Cristales 6 mm
LOS PERFILES SIN DEFORMACIÓN
CONSERVAN SU FUNCIONAMIENTO

Aumenta la Hermeticidad Acústica, Colocando Vinil por Ambos Lados

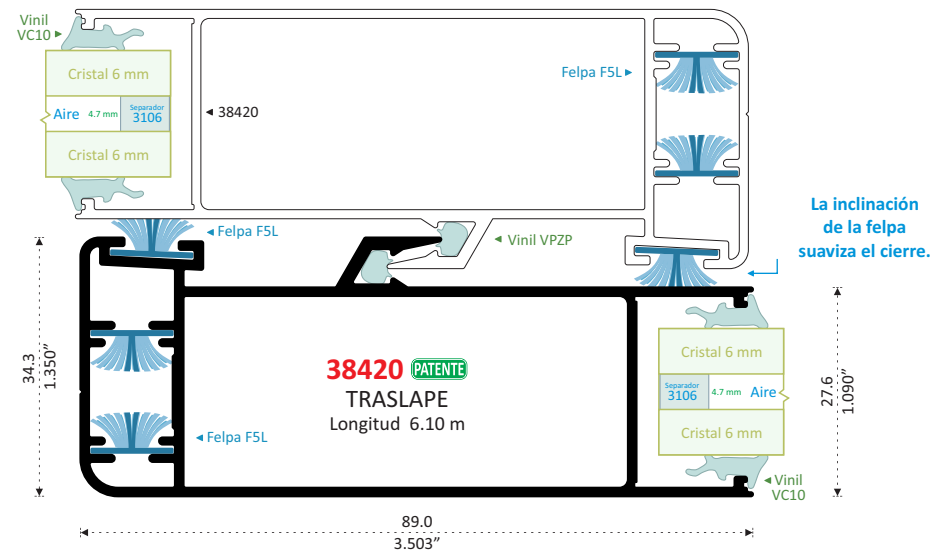
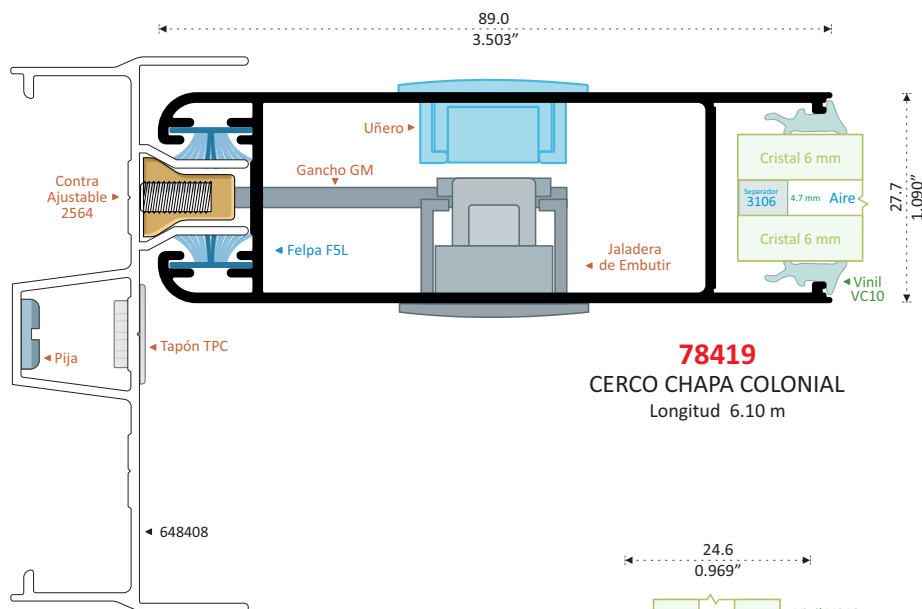

La inclinación de la felpa suaviza el cierre.

32437 PATENTE
ZOCLO Y CABEZAL
Longitud 6.10 m

24.8
0.976"

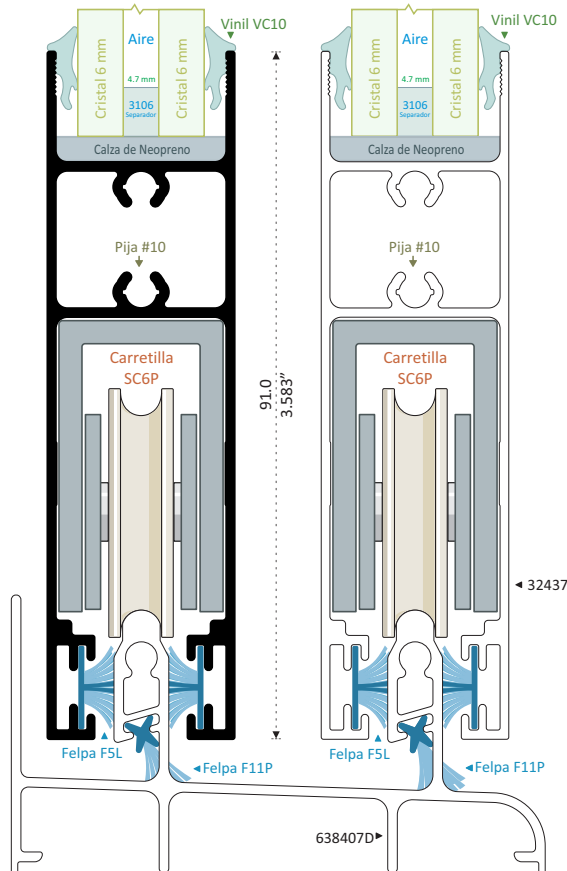
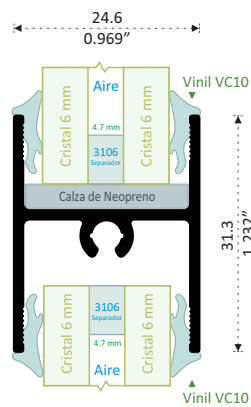

MOSQUITERO
INTERIOR

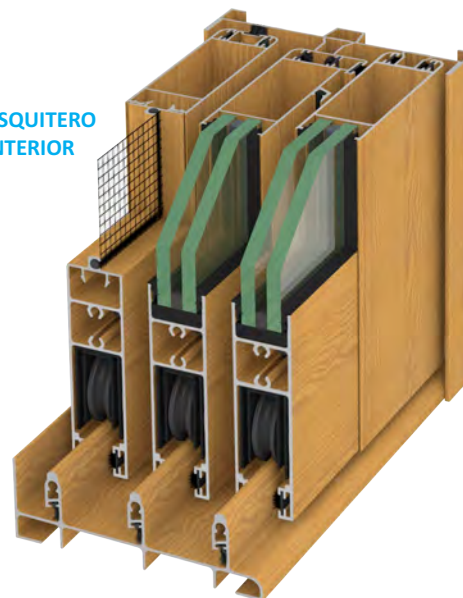

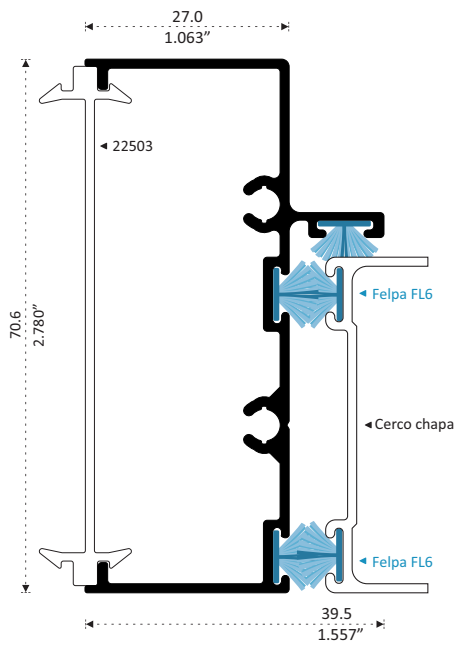

12757
BATIENTE
Longitud 6.10 m

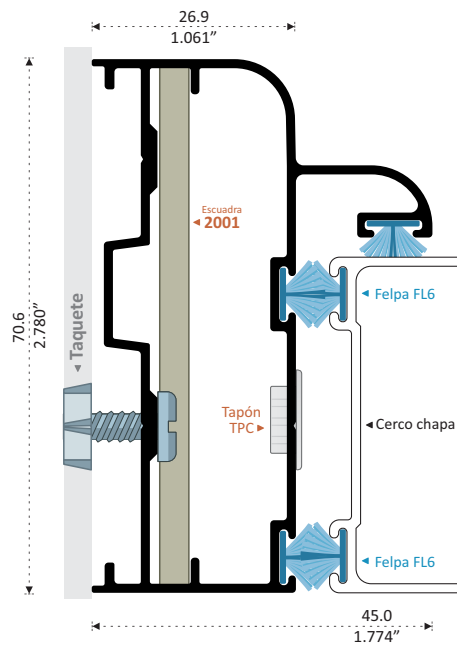

12618
BATIENTE COLONIAL
Longitud 6.10 m

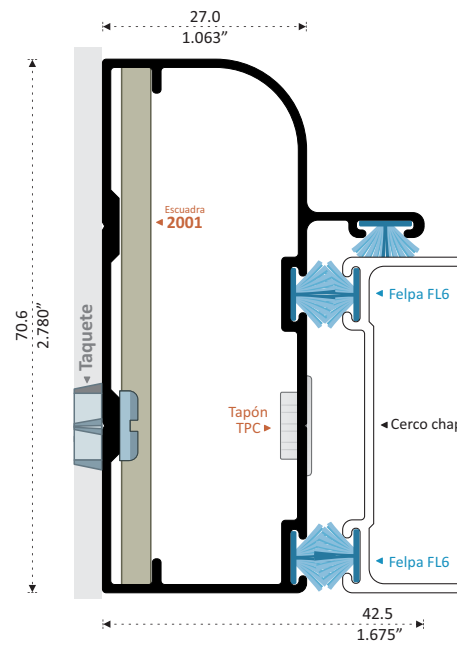

22757
BATIENTE COLONIAL
Longitud 6.10 m

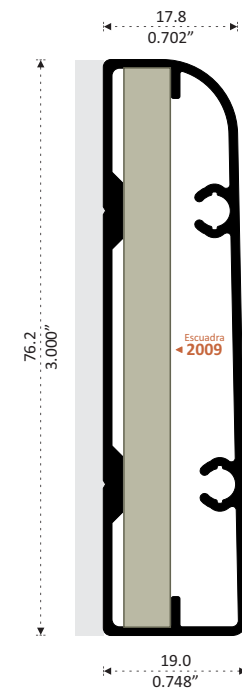

9245 PATENTE
MARCO COLONIAL
Longitud 6.10 m

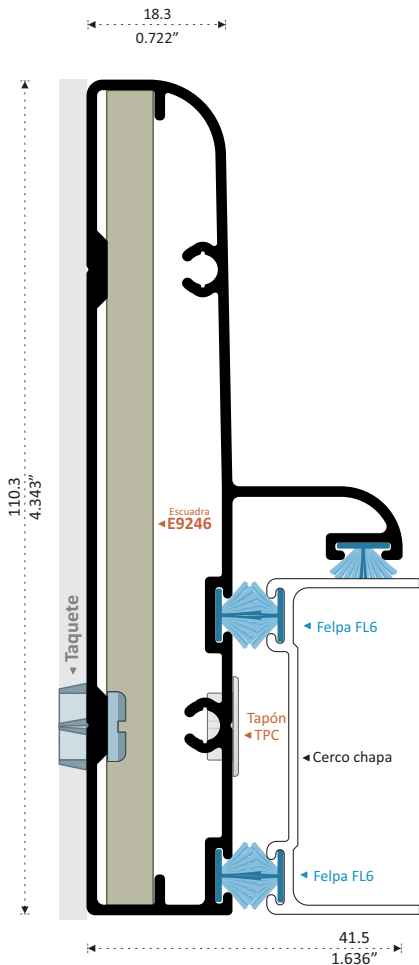

9246 PATENTE
BATIENTE COLONIAL
Longitud 6.10 m

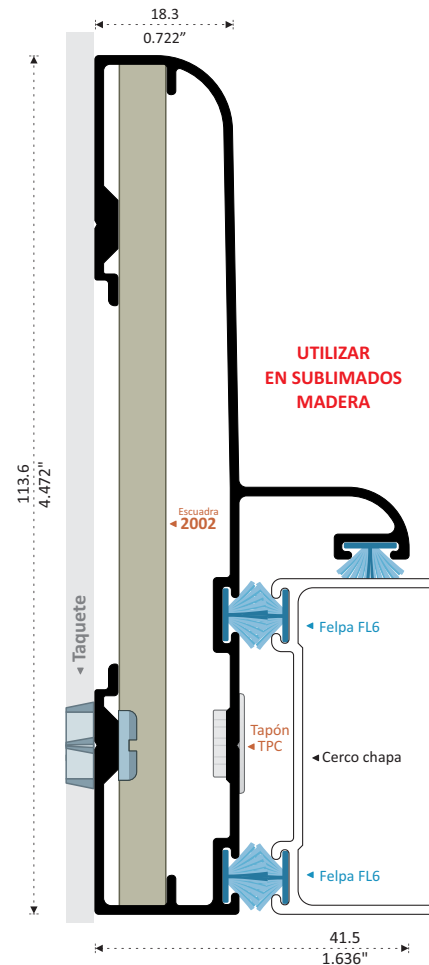

69246
BATIENTE COLONIAL
Longitud 6.10 m

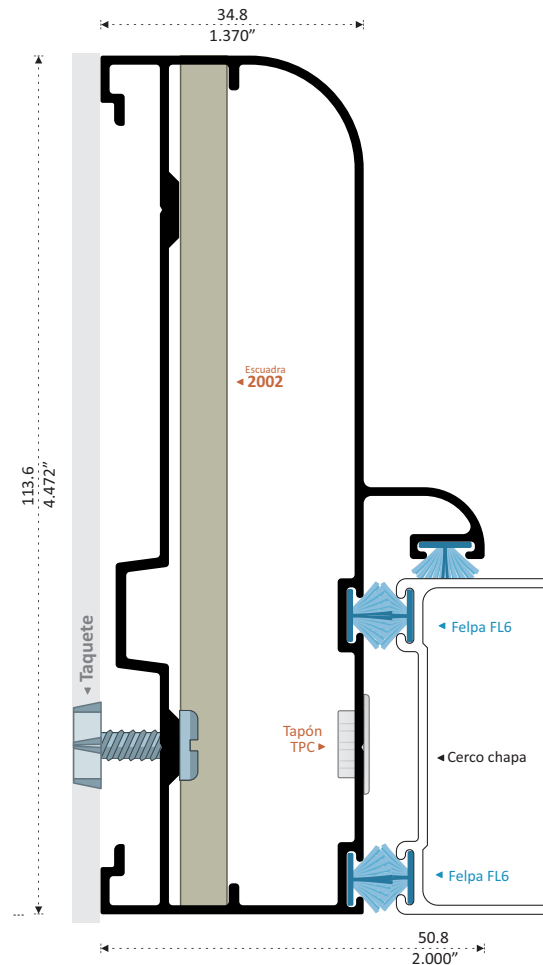

9242
BATIENTE COLONIAL
Longitud 6.10 m

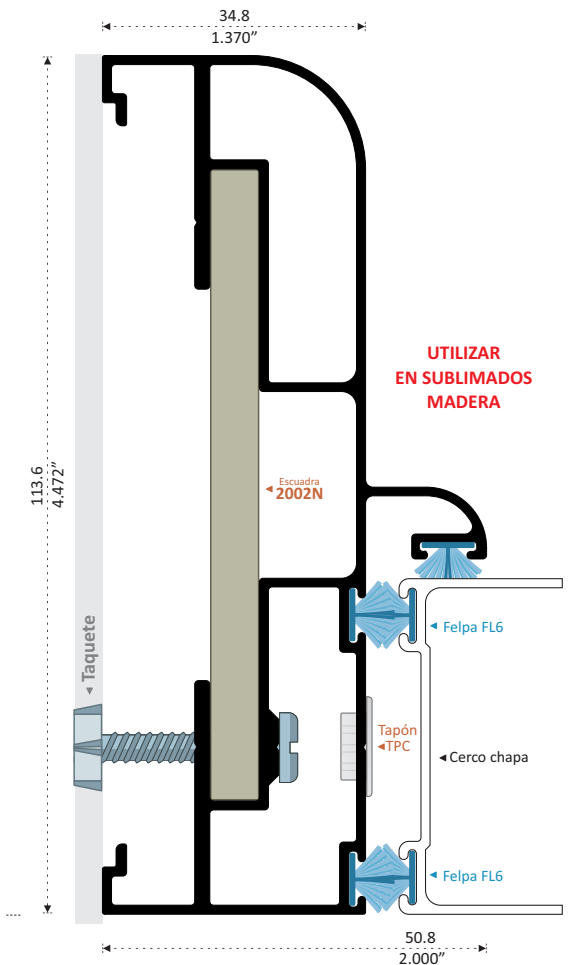

19242
BATIENTE COLONIAL
Longitud 6.10 m

LÍNEA SERIE 100 HERMÉTICA RECIBE CRISTAL

6 mm o 9 mm



Convierte un Producto Perfilletto En Extraordinario

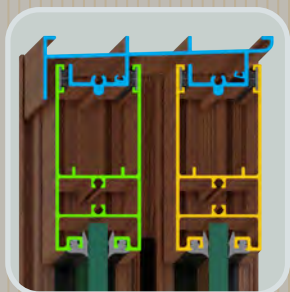

Riel Doble Guía
Opcional
Dos Hojas Móviles

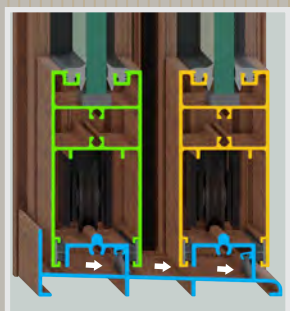

Mejor Salida de Agua por:
- Riel con Pared Interior Alta
- Inclinación de Riel
- Drenes Inferiores

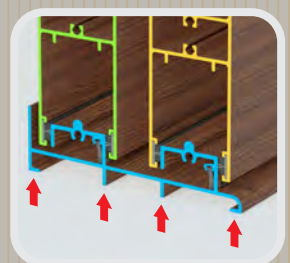

Resistencia de
4 Puntos de Apoyo
para Cristales Pesados



Mayor Hermeticidad
por Doble Felpa entre
Zoclo y Riel

Mayor Hermeticidad por Rozamiento de Felpas F5L con Labios Textiles



2 Felpas Horizontales
en Zoclo

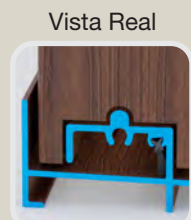

Vista Real



2 Felpas Verticales
en Traslapes



Zoclo Entra Hasta
el Fondo de
Cercos Chapa y Traslape

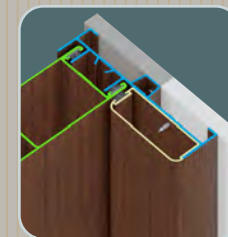

Vista Elegante por
Cubierta Colonial

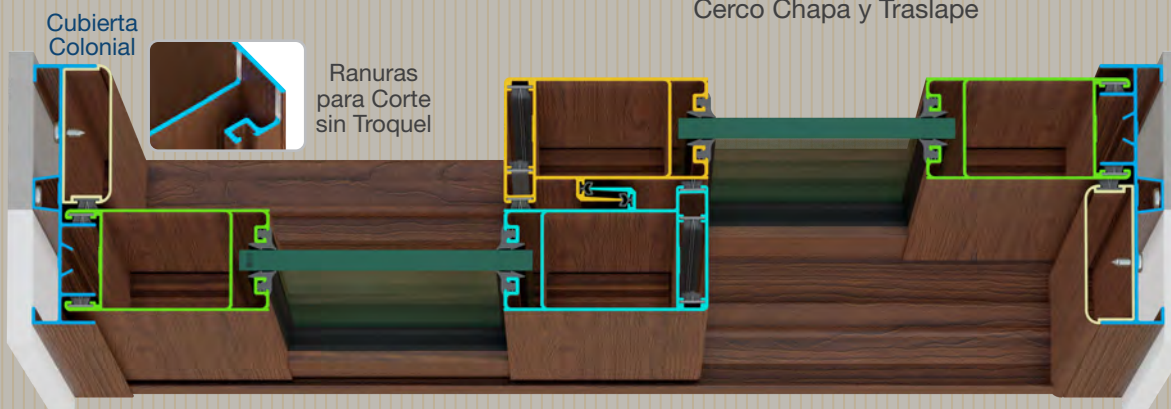

Cubierta
Colonial

Ranuras
para Corte
sin Troquel



Mayor Firmeza
de
Vinilos Respaldo

Doble Vinil Respaldo
Aumenta
Aislamiento Acústico

Hermeticidad entre Traslapes
por 2 Vinilos Hongo y 6 Felpas

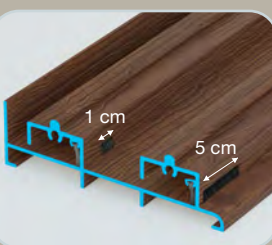

Aumentan la Hermeticidad:
- Aislamiento Acústico
- Resistencia a Viento
- Filtra Polvo
- Salida de Agua
- Impide Entrada de Insectos

Riel Inferior
Incluye Drenes cada 40 cm
Colocar Felpa F11P

Descubre otras Opciones
para tu Cancelería

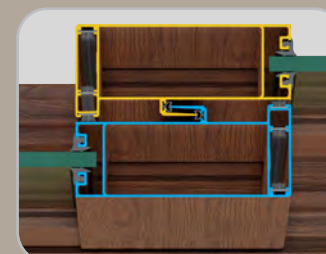

Perfiles Reforzados 5"

Instale las hojas
que Requiera

Riel Superior

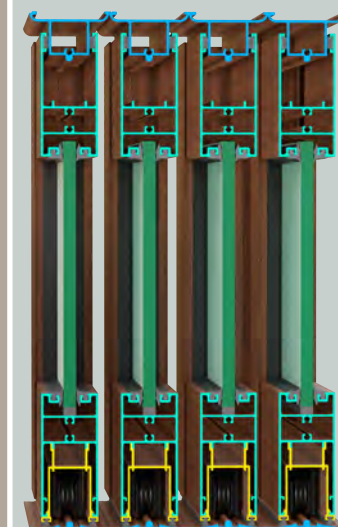

Riel Sencillo a Piso

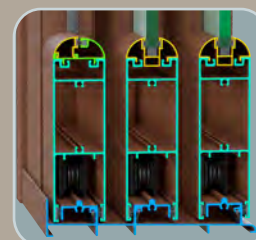

Adaptadores Coloniales
con Mosquero Interior
Riel Triple

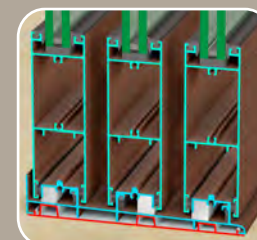

Soportes en
Cristales Pesados

■ Aislamiento Acústico Ventana 40.9 Decibles
Puerta 36.1 Decibles

■ Permeabilidad a Viento y Polvo Ventana Aire que Detiene 84%
Puerta Aire que Detiene 85%

■ Resistencia A Vientos Sin Deformar el Perfil Ventana 120 Km/h Perfiles 3.5"
Puerta 120 Km/h Perfiles 5"

AISLAMIENTO ACÚSTICO
REALIZADO CON 120 DECIBELES AL EXTERIOR
MEDIDA 1.00 x 1.00 m

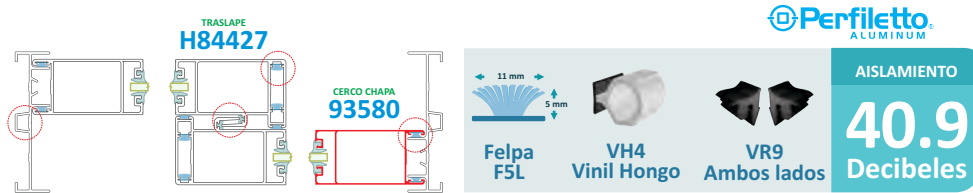

LÍNEA EXCLUSIVA PERFILETTO

LÍNEA EXCLUSIVA PERFILETTO

PERMEABILIDAD AL AGUA DURANTE 20 MINUTOS

VENTANA MEDIDA 1.00 x 1.00 m

VELOCIDAD KM/H	Agua	Aire	SIN MOSQUITERO	MOSQUITERO ENROLLABLE INTERIOR
20	50%	50%	Sin Filtraciones	Sin Filtraciones
40	50%	50%		
60	50%	50%		
80	50%	50%		
100	50%	50%		
120	60%	40%		

PUERTA MEDIDA 1.00 x 1.00 m

VELOCIDAD KM/H	Agua	Aire	SIN MOSQUITERO	MOSQUITERO ENROLLABLE INTERIOR
20	50%	50%	Sin Filtraciones	Sin Filtraciones
40	50%	50%		
60	50%	50%		
80	50%	50%		
100	50%	50%		
120	60%	40%		

PERMEABILIDAD AL VIENTO Medida 1.00 x 1.00 m

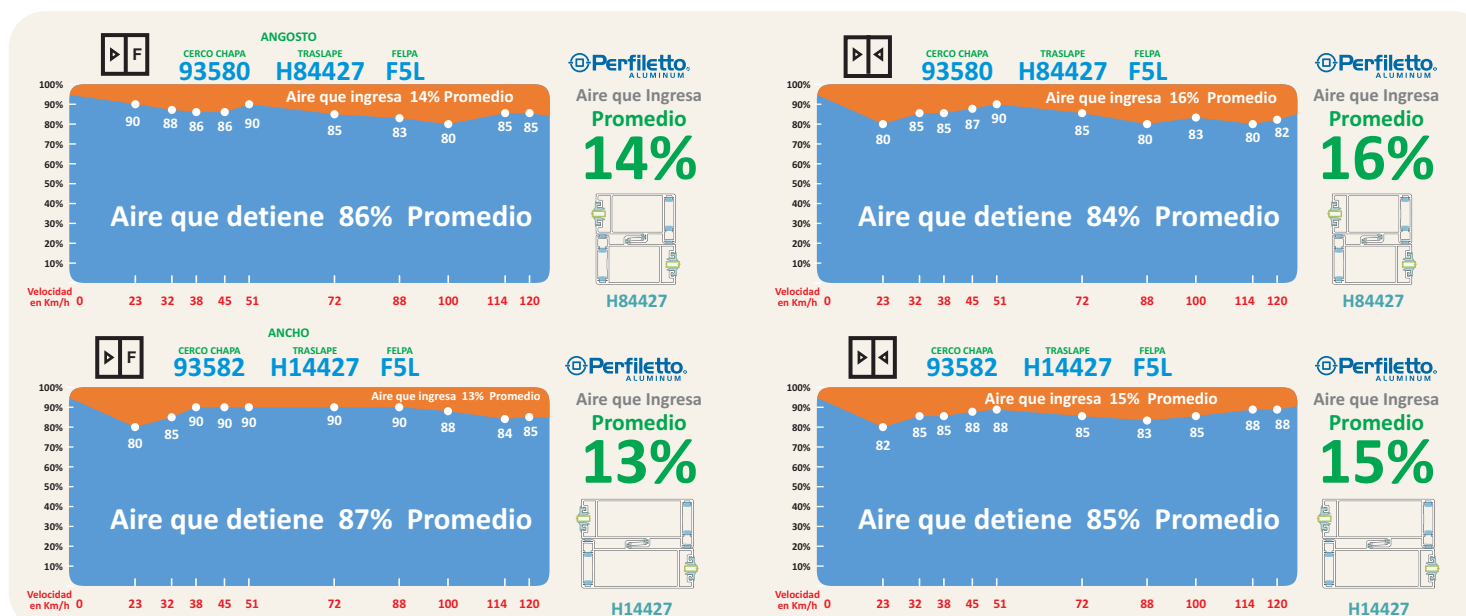

LÍNEA EXCLUSIVA PERFILETTO

RESISTENCIAS A VIENTOS

VENTANA
Prueba Realizada
30 Repeticiones de 1 Minuto c/u
A 120 Km/h
Medida 1.00 x 1.00 m
Cristal 6 mm
LOS PERFILES SIN DEFORMACIÓN
CONSERVAN SU
FUNCIONAMIENTO

PUERTA
Prueba Realizada
30 Repeticiones de 1 Minuto c/u
A 120 Km/h
Medida 2.00 X 2.10 m
Cristal 6 mm
LOS PERFILES SIN DEFORMACIÓN
CONSERVAN SU
FUNCIONAMIENTO

Más Hermética al: **Viento, Ruido y Temperatura** por su Felpa de 11 mm

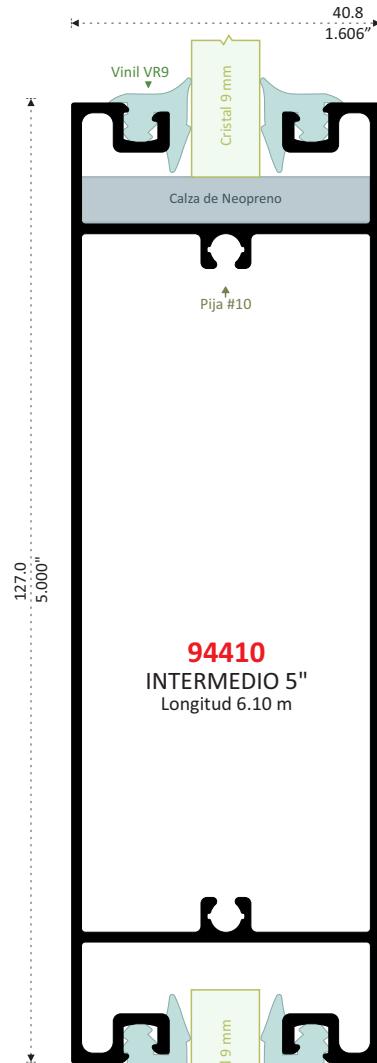

- MAYOR AISLAMIENTO ACÚSTICO
- MAYOR RESISTENCIA A VIENTOS

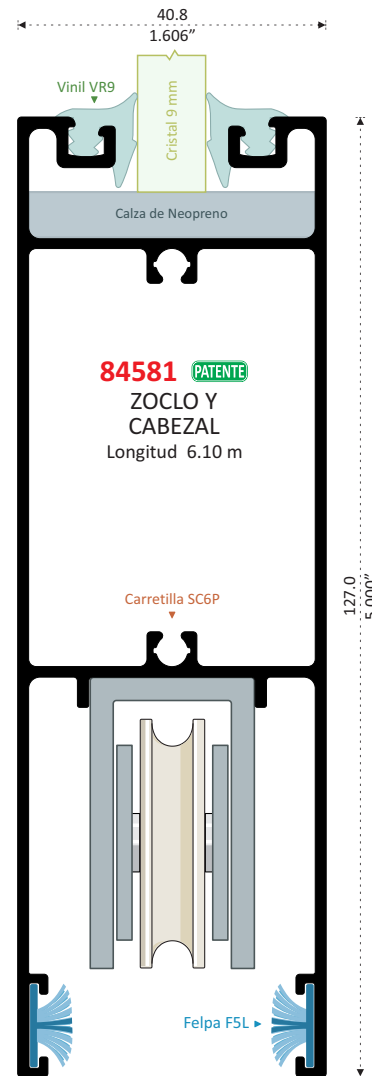
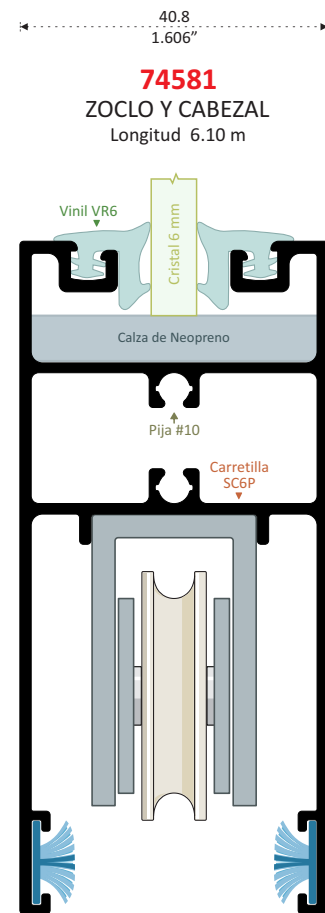
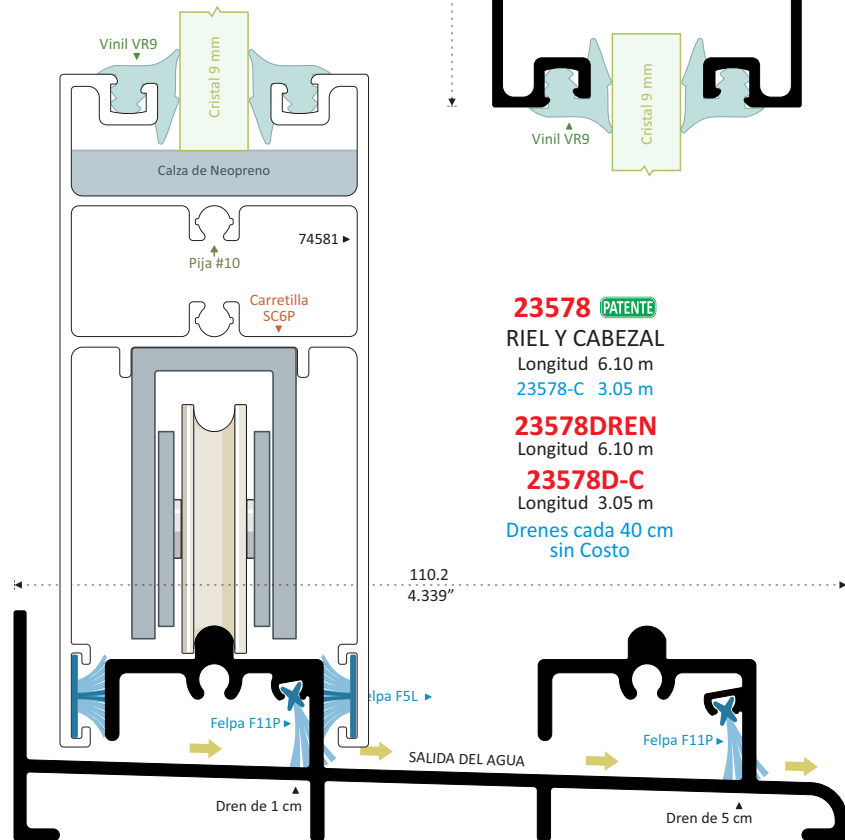
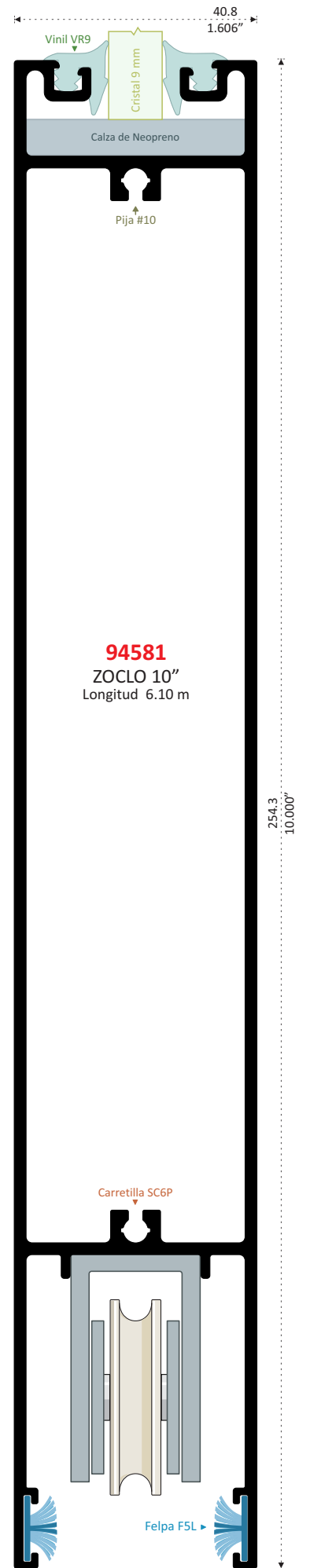

Más Hermética al: **Viento, Ruido y Temperatura** por su **Felpa de 11 mm**

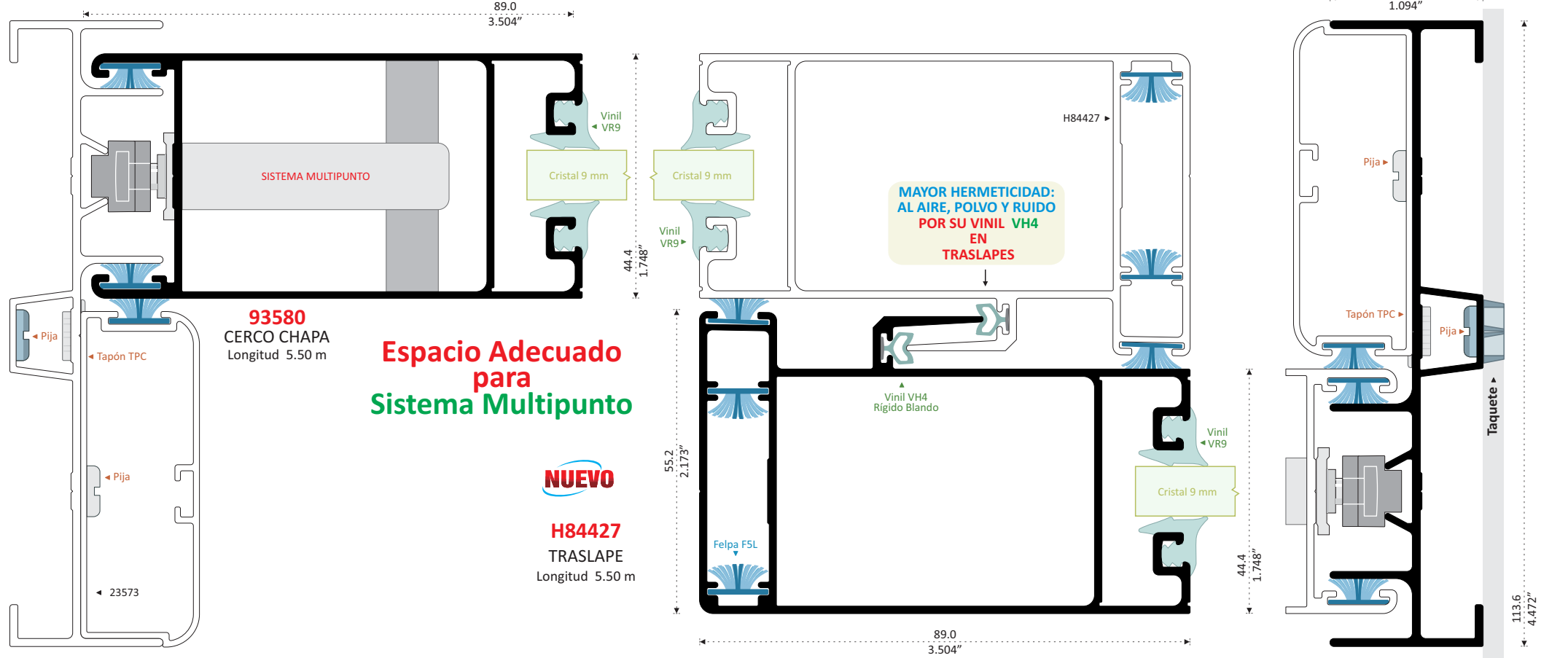

**Espacio Adecuado
para
Sistema Multipunto**

NUEVO

H84427
TRASLAPE
Longitud 5.50 m

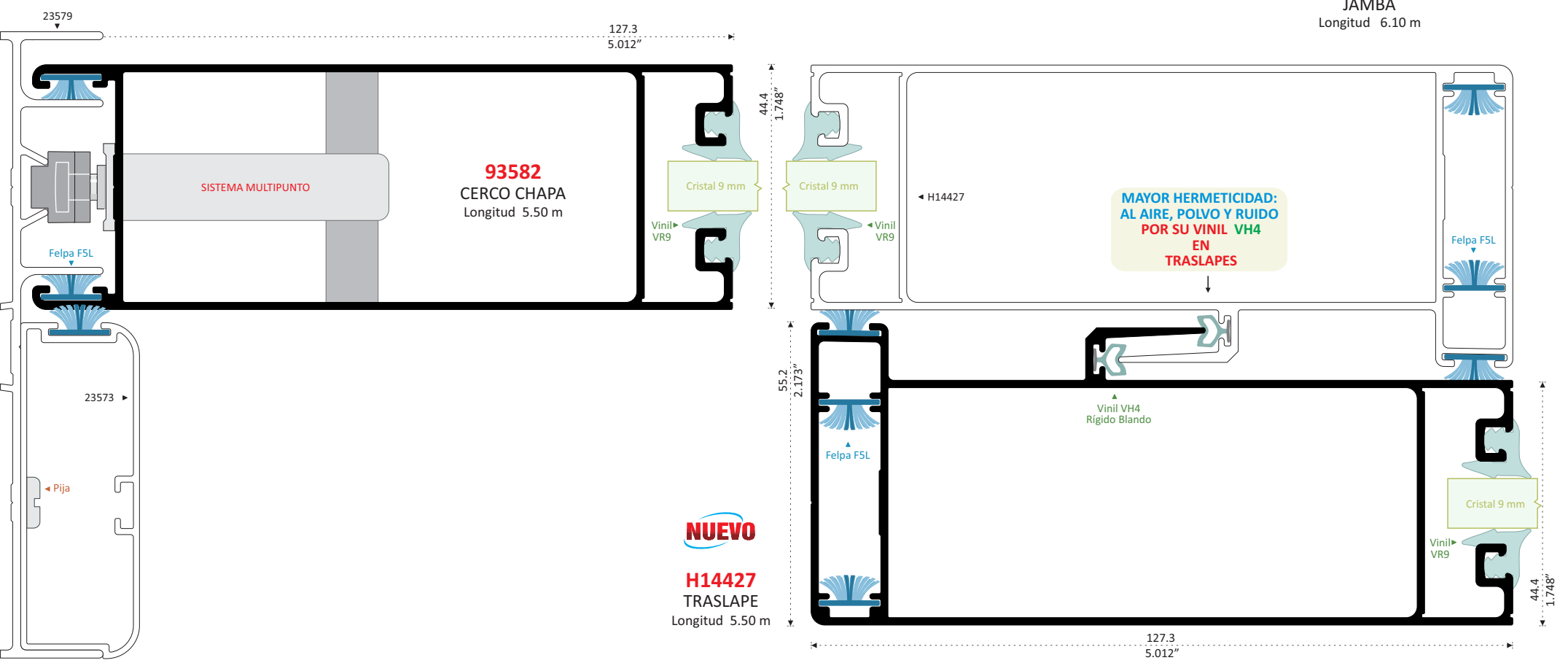

NUEVO

H14427
TRASLAPE
Longitud 5.50 m

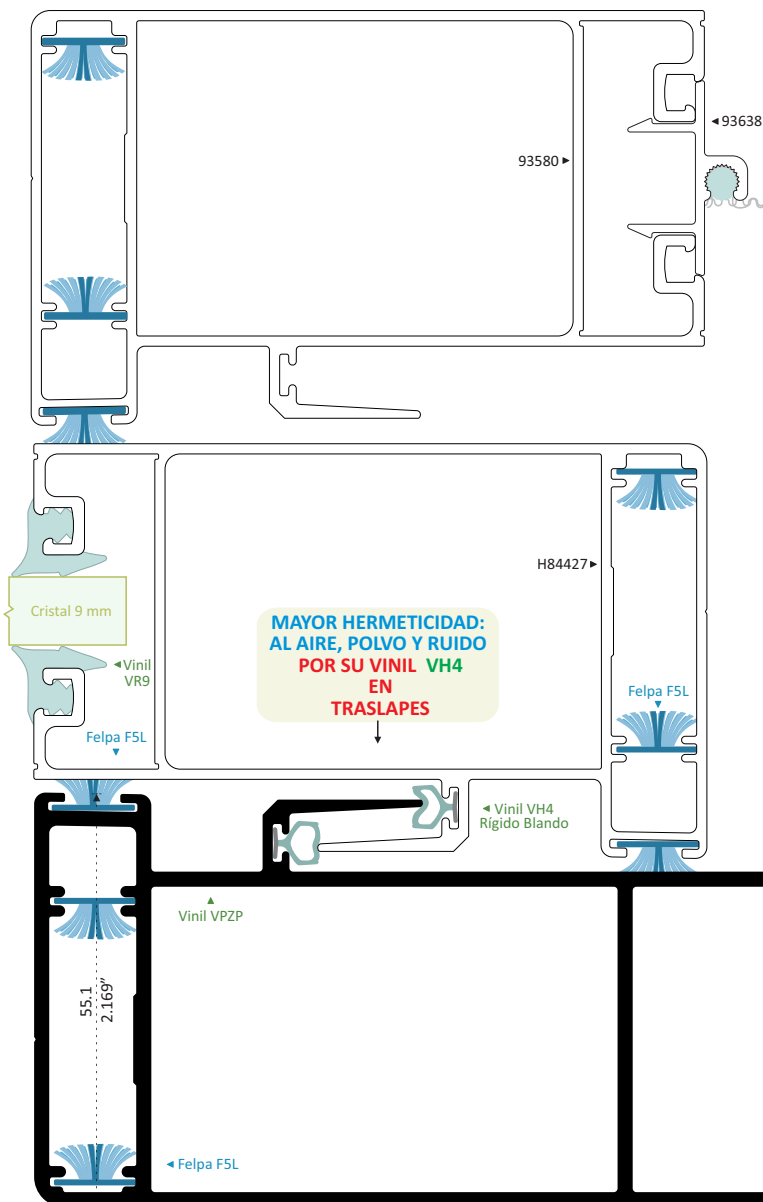

MAYOR HERMETICIDAD:
AL AIRE, POLVO Y RUIDO
POR SU VINIL VH4
EN
TRASLAPES

44427 PATENTE
CERCO TRASLAPE 11"
Longitud: 6.10 m

PANORÁMICA



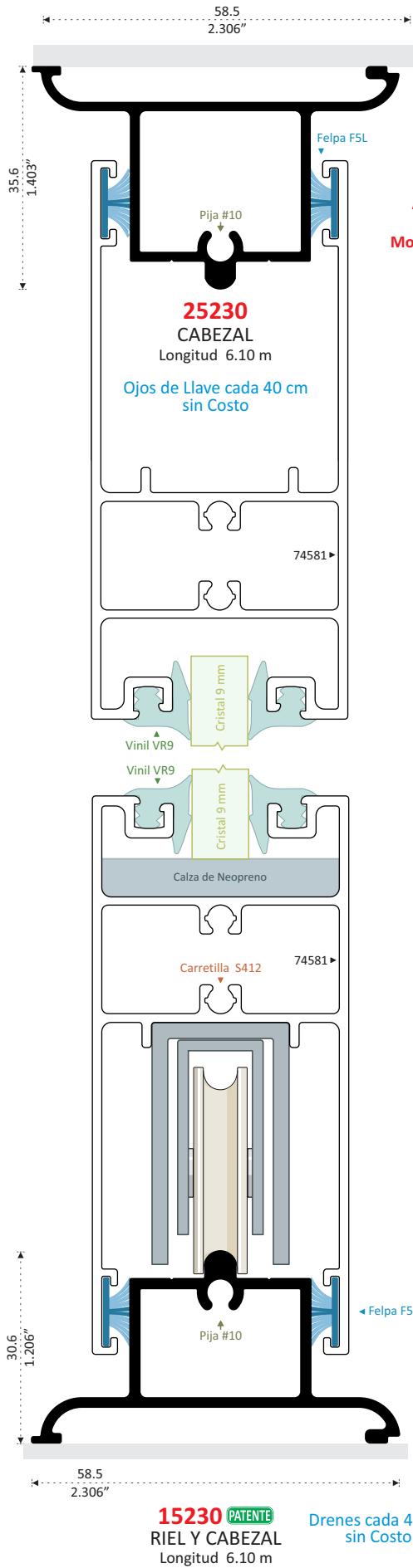

Por su Altura Absorbe 12 mm en Movimientos de Losa.

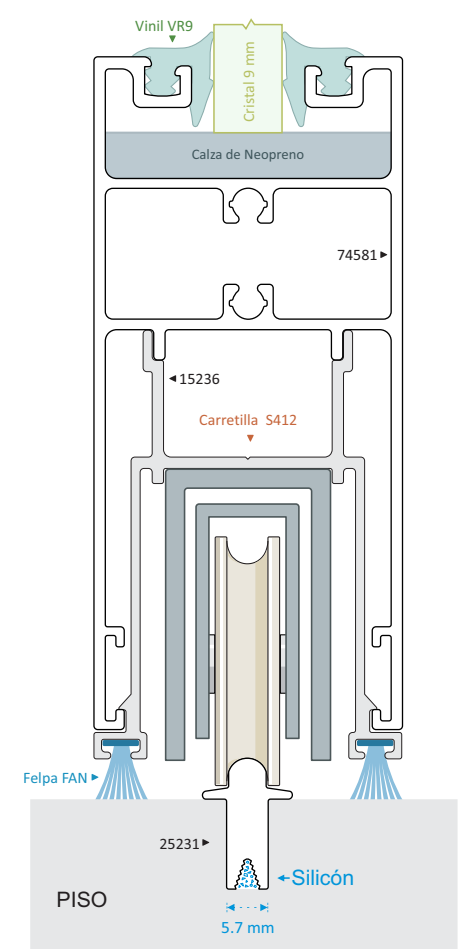
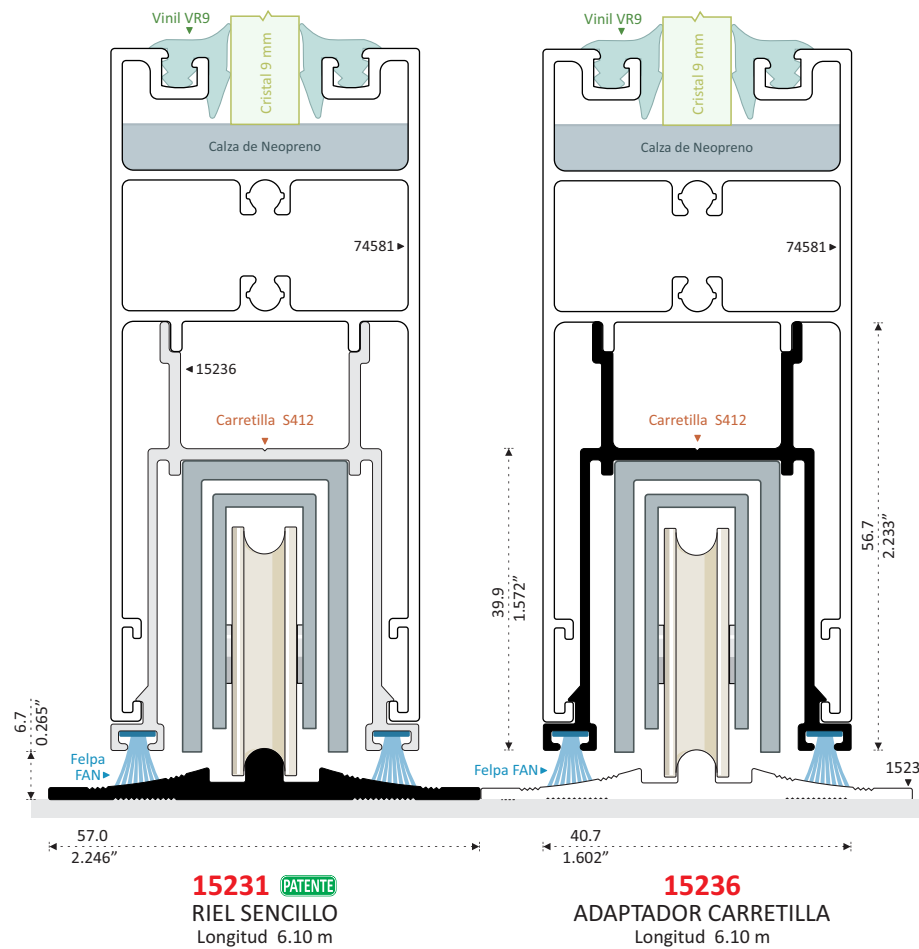
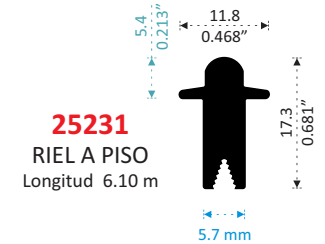
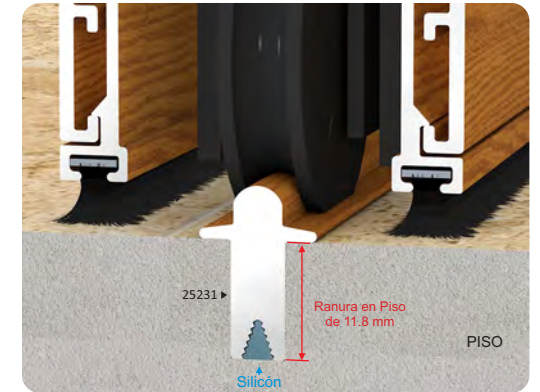
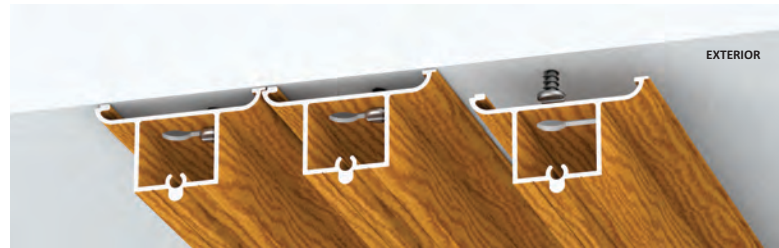
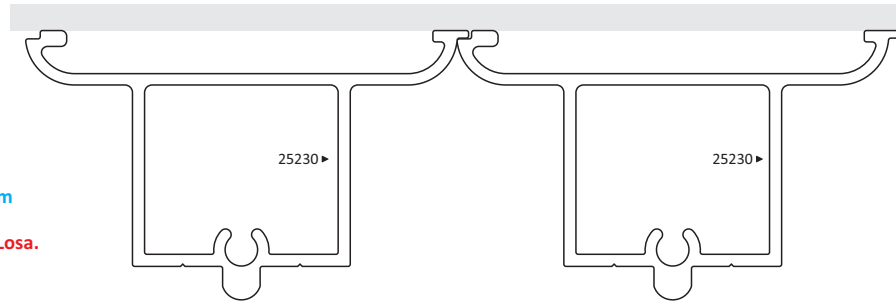

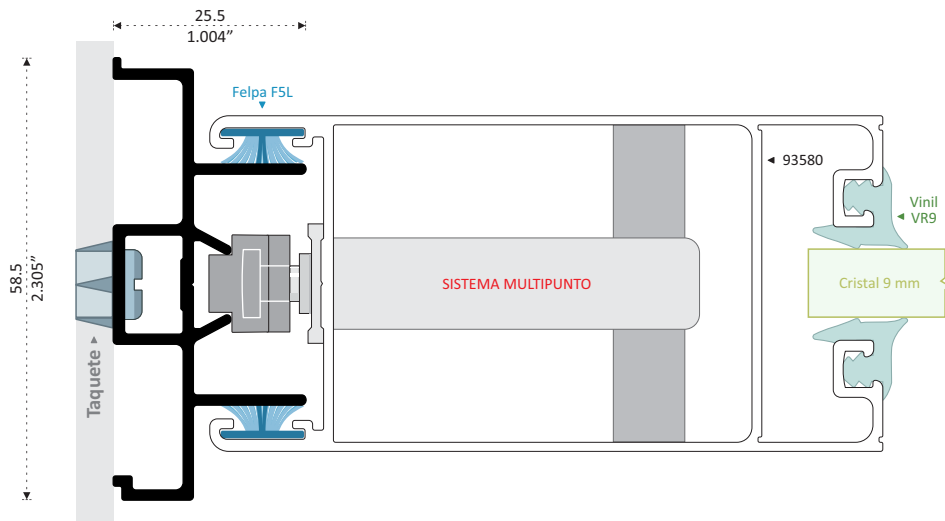

15232 PATENTE
JAMBA SENCILLA
Longitud 6.10 m

93642
ADAPTADOR CURVO
Longitud 6.10 m

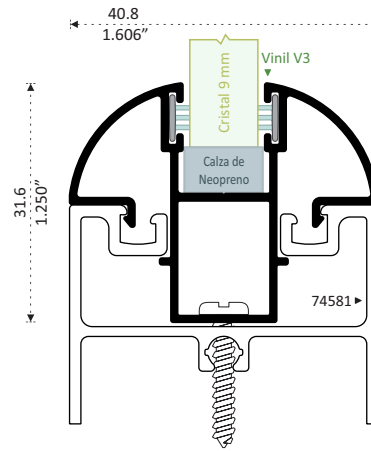

93643 PATENTE
ADAPTADOR CURVO
Longitud 6.10 m

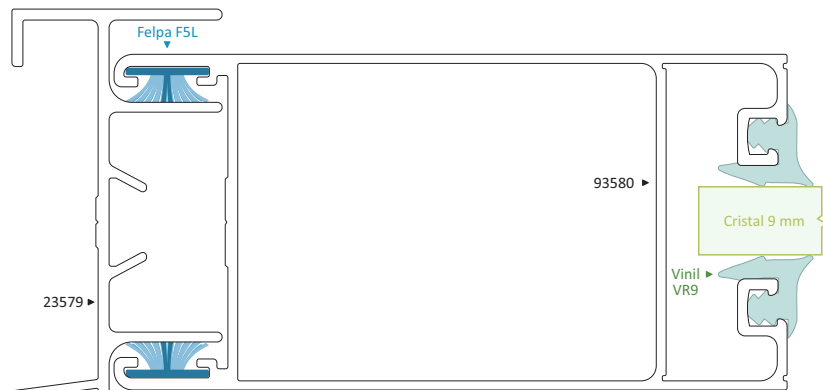
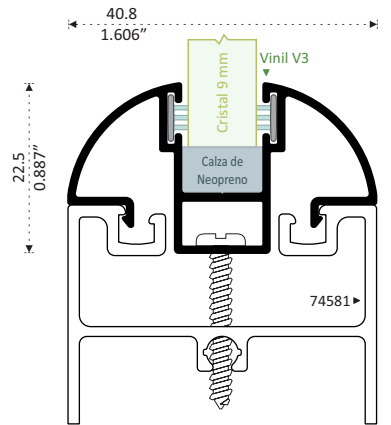

23573
CUBIERTA
Longitud 6.10 m

NUEVO

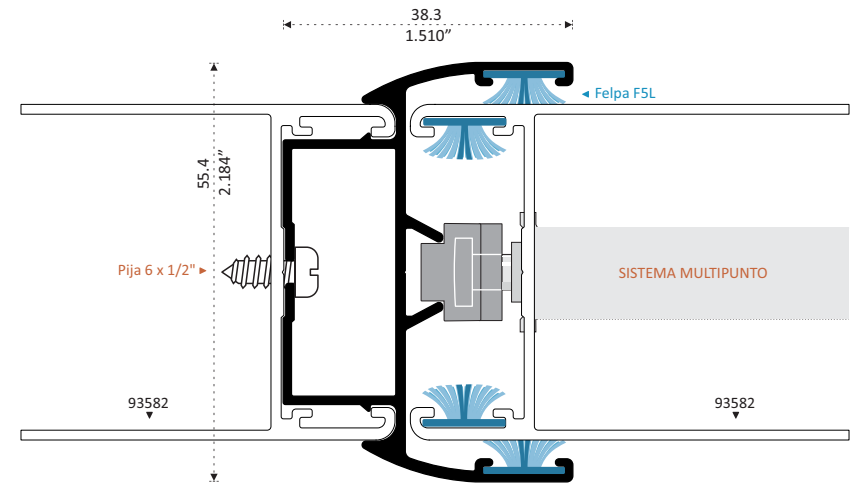

33637
ADAPTADOR
Longitud 6.10 m

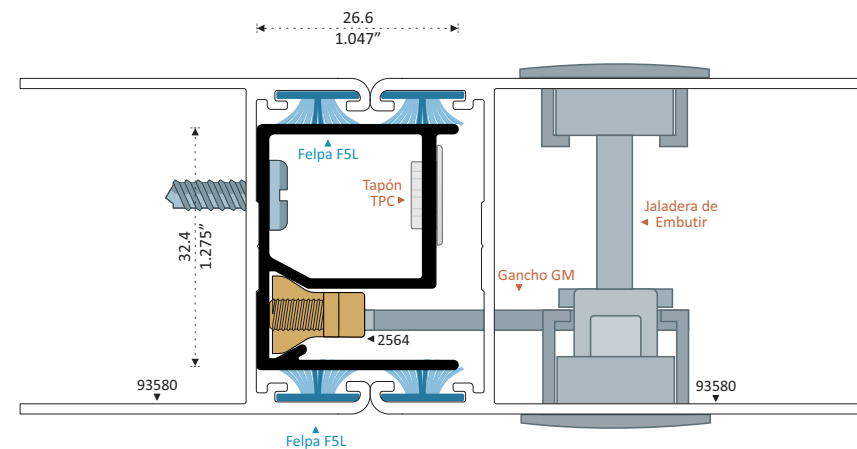

13637 PATENTE
ADAPTADOR
Longitud 6.10 m

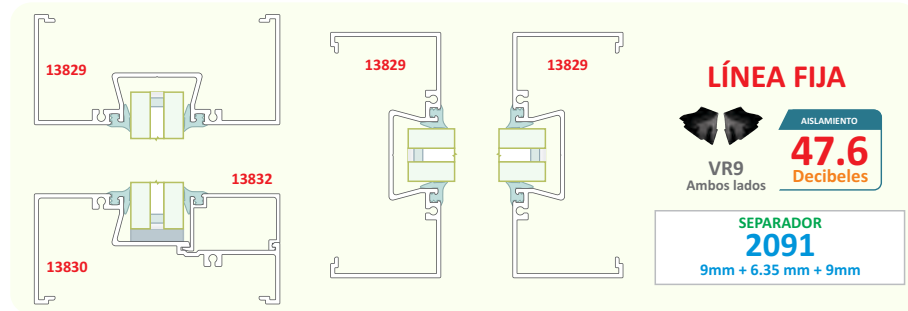

**Aumenta la Hermeticidad Acústica,
Colocando Vinil por Ambos Lados**

Cristal 6 mm con Vinil VR9 y Separador de 12.7 mm

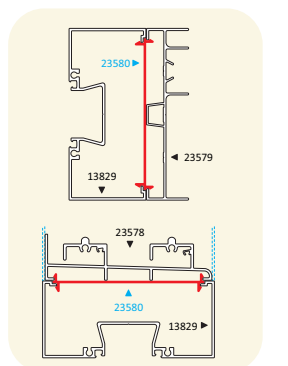
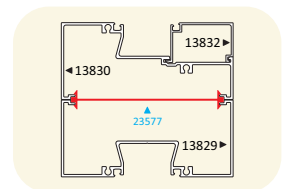
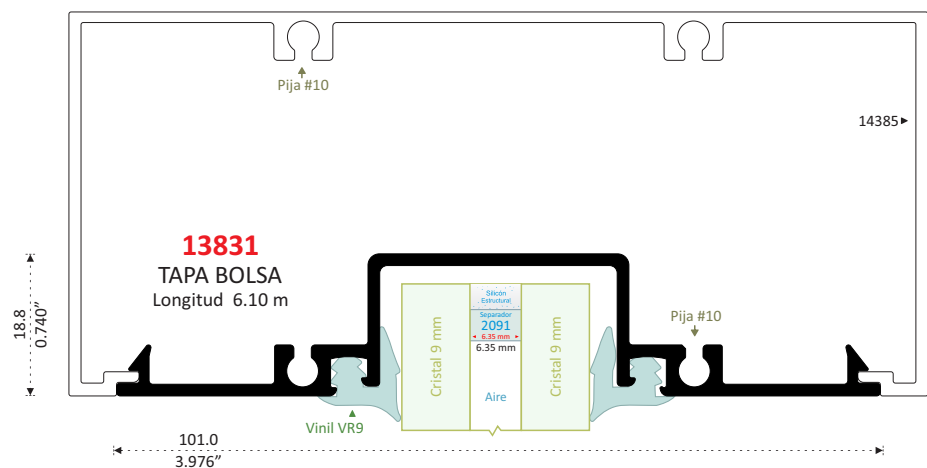
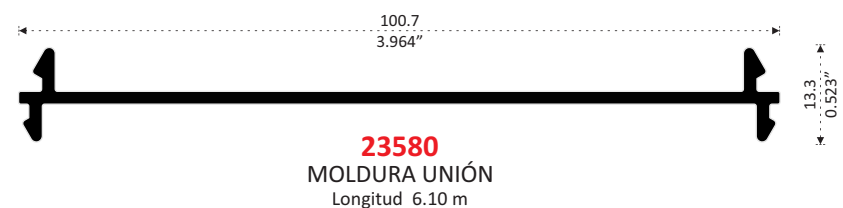
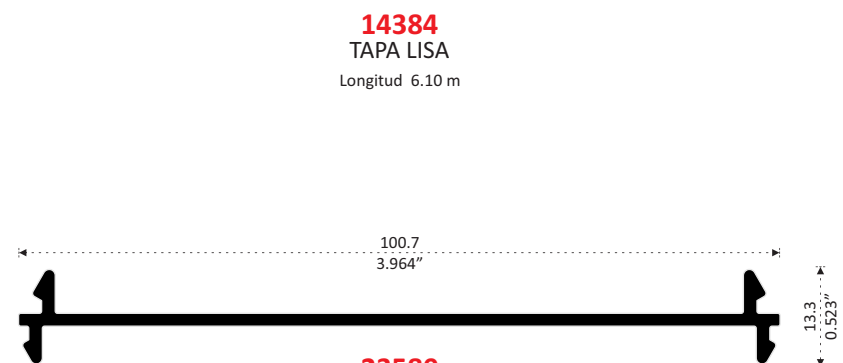
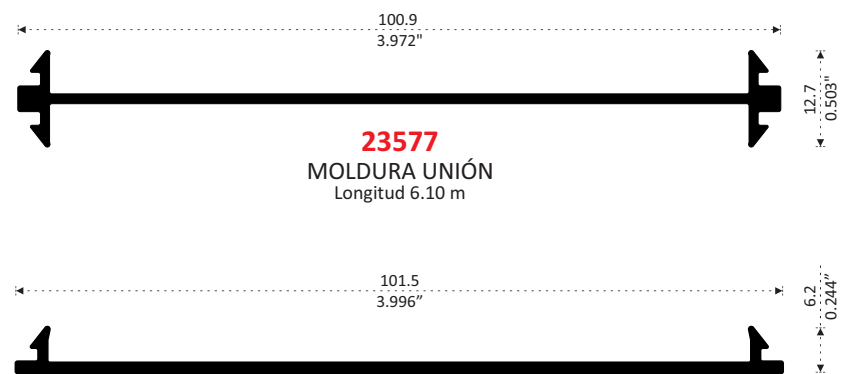
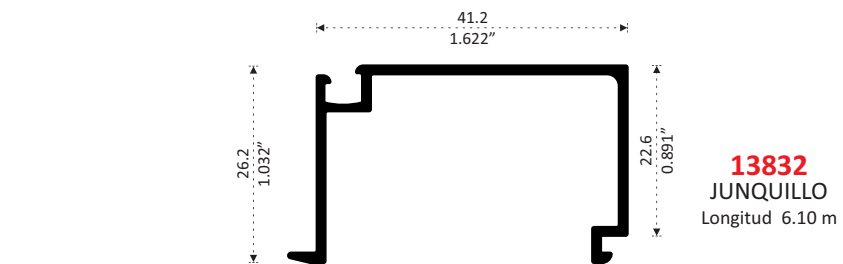
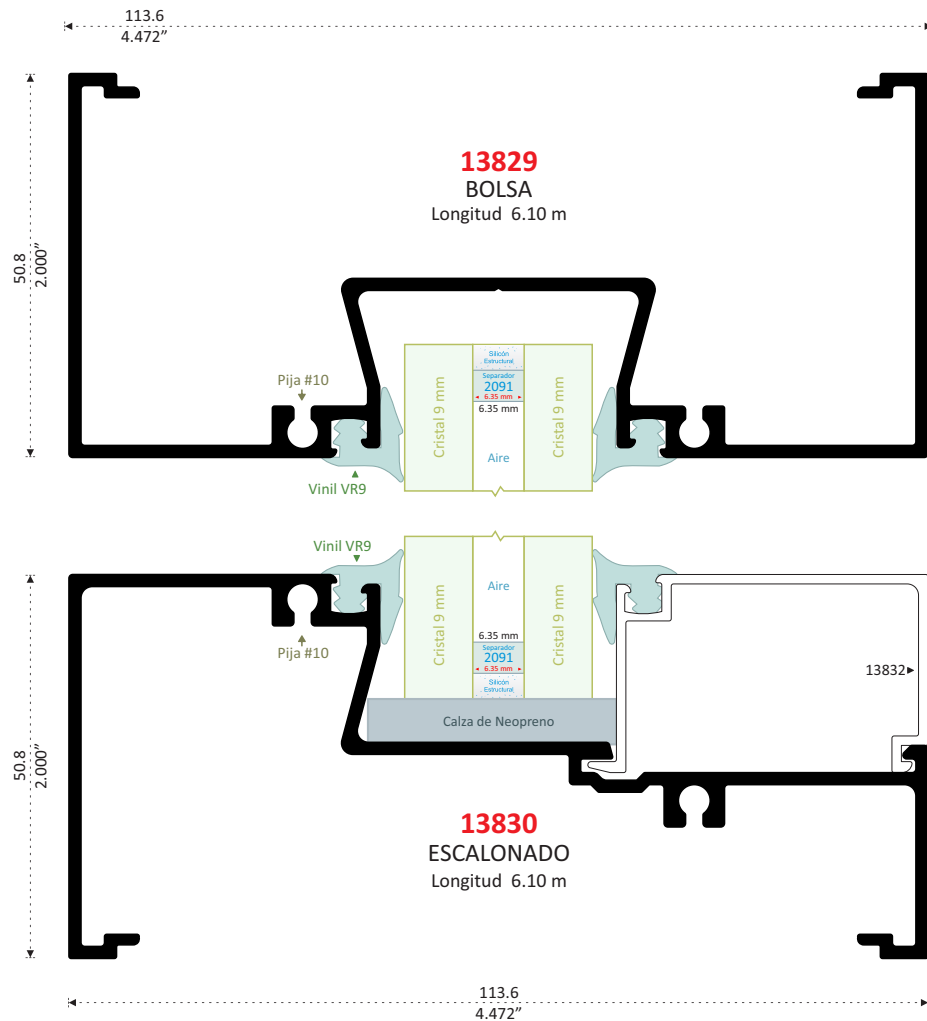
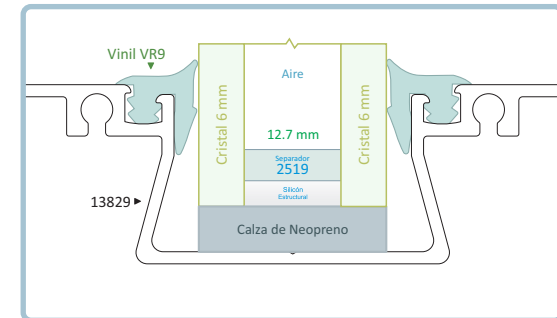

LÍNEA SERIE 100 CRISTAL DOBLE HERMÉTICA

Convierte un Producto Perfiletto En Extraordinario



Riel Doble Guía Opcional Dos Hojas Móviles

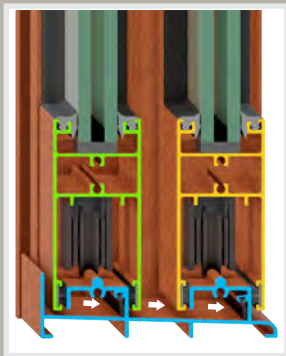

Mejor Salida de Agua por:
- Riel con Pared Interior Alta
- Inclinación de Riel
- Drenes Inferiores

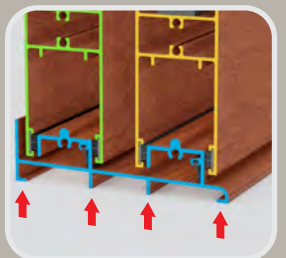

Resistencia de 4 Puntos de Apoyo para Cristales Pesados



Mayor Hermeticidad por Doble Felpa entre Zoclo y Riel

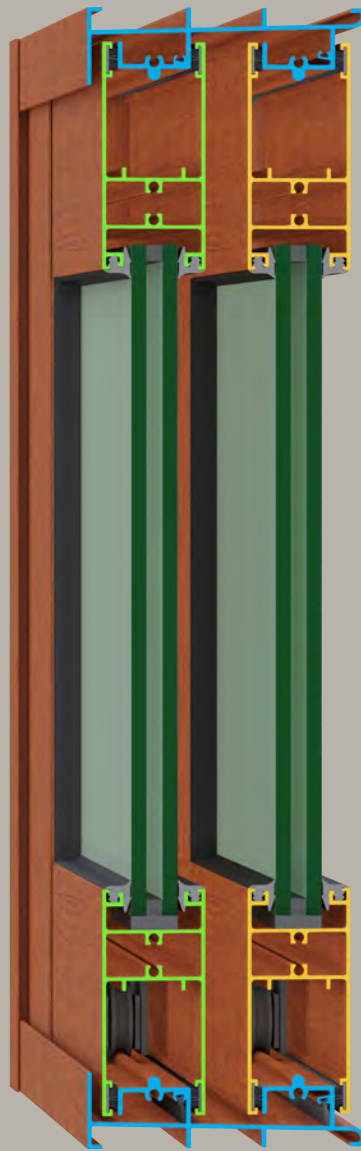

Mayor Hermeticidad por Rozamiento de Felpas F5L



2 Felpas Horizontales en Zoclo

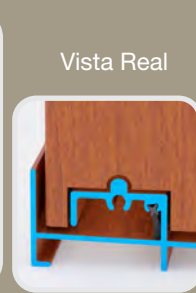

Vista Real

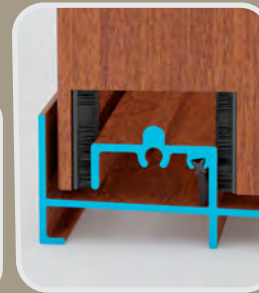

2 Felpas Verticales en Traslapes



Zoclo Entra Hasta el Fondo de Cerco Chapa y Traslape

Cubierta Colonial



Ranuras para Corte sin Troquel

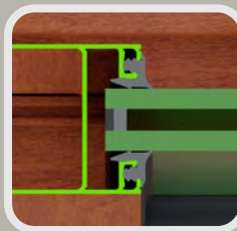
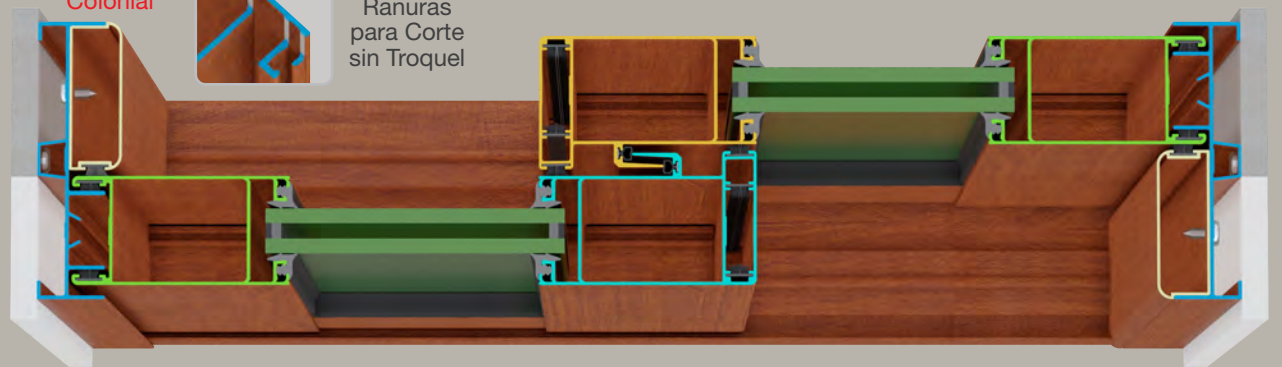

Mayor Firmeza de Vinilos Respaldo

Doble Vinil Respaldo Aumenta Aislamiento Acústico

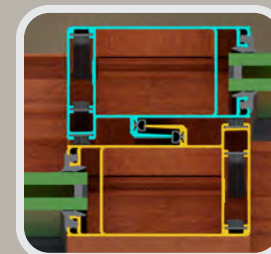

Hermeticidad entre Traslapes por 2 Vinilos Hongo y 6 Felpas

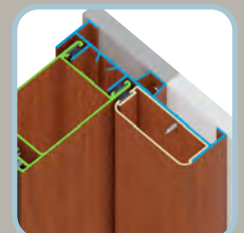

Vista Elegante con Cubierta Jamba

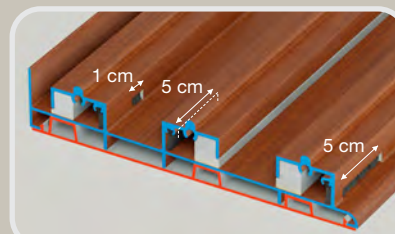

Aumentan la Hermeticidad:

- Aislamiento Acústico
- Resistencia a Viento
- Filtra Polvo
- Salida de Agua
- Impide Entrada de Insectos

Riel Inferior Incluye Drenes cada 40 cm Colocar Felpa F11P

Descubre otras Opciones para tu Cancelería

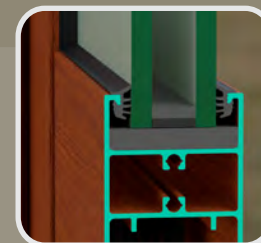

Separador de 1/2" Vinil en Ambos Lados

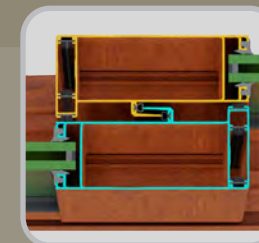

Perfiles Reforzados de 5 Pulgadas

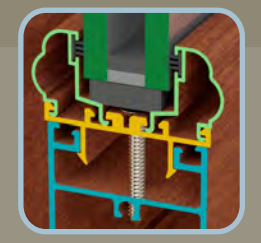

Adaptable a Junquillos Puerta Multi-diseños

■ Aislamiento Acústico Ventana 38.2 Decibles Puerta 39.8 Decibles

■ Permeabilidad a Viento y Polvo Ventana Aire que Detiene 80% Puerta Aire que Detiene 82%

■ Resistencia A Vientos Sin Deformar el Perfil Ventana 120 Km/h Perfiles 3.5" Puerta 120 Km/h Perfiles 5"

AISLAMIENTO ACÚSTICO
REALIZADO CON 120 DECIBELES AL EXTERIOR
MEDIDA 1.00 x 1.00 m

SEPARADOR
2091
6mm + Separador 6.35 mm + 6mm

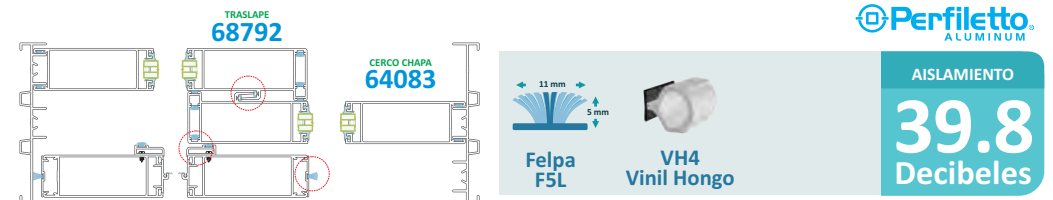

LÍNEA EXCLUSIVA PERFILETTO

LÍNEA EXCLUSIVA PERFILETTO

PERMEABILIDAD AL AGUA DURANTE 20 MINUTOS

▶◀ VENTANA MEDIDA 1.00 x 1.00 m

VELOCIDAD KM/H	Agua	Aire
20	50%	50%
40	50%	50%
60	50%	50%
80	50%	50%
100	50%	50%
120	60%	40%

SIN MOSQUITERO
Sin Filtraciones

MOSQUITERO ENROLLABLE INTERIOR
Sin Filtraciones

▶▶◀ VENTANA MEDIDA 1.00 x 1.00 m

VELOCIDAD KM/H	Agua	Aire
20	50%	50%
40	50%	50%
60	50%	50%
80	50%	50%
100	50%	50%
120	60%	40%

SIN MOSQUITERO
Sin Filtraciones

MOSQUITERO CORREDIZO INTERIOR
Sin Filtraciones

MOSQUITERO CORREDIZO EXTERIOR

VELOCIDAD KM/H	Agua	Aire	Litros Filtrados
20	50%	50%	0.20
40	50%	50%	0.58
60	50%	50%	1.92
80	50%	50%	2.68
100	50%	50%	4.79
120	60%	40%	5.67

MOSQUITERO CORREDIZO EXTERIOR
OCCASIONA ALTA FILTRACIÓN DE AGUA

▶◀ PUERTA MEDIDA 1.00 x 1.00 m

VELOCIDAD KM/H	Agua	Aire
20	50%	50%
40	50%	50%
60	50%	50%
80	50%	50%
100	50%	50%
120	60%	40%

SIN MOSQUITERO
Sin Filtraciones

MOSQUITERO ENROLLABLE INTERIOR
Sin Filtraciones

▶▶◀ PUERTA MEDIDA 1.00 x 1.00 m

VELOCIDAD KM/H	Agua	Aire
20	50%	50%
40	50%	50%
60	50%	50%
80	50%	50%
100	50%	50%
120	60%	40%

SIN MOSQUITERO
Sin Filtraciones

MOSQUITERO CORREDIZO INTERIOR
Sin Filtraciones

MOSQUITERO CORREDIZO EXTERIOR

VELOCIDAD KM/H	Agua	Aire	Litros Filtrados
20	50%	50%	0.28
40	50%	50%	0.72
60	50%	50%	2.10
80	50%	50%	2.75
100	50%	50%	4.92
120	60%	40%	5.65

MOSQUITERO CORREDIZO EXTERIOR
OCCASIONA ALTA FILTRACIÓN DE AGUA

PERMEABILIDAD AL VIENTO Medida 1.00 x 1.00 m

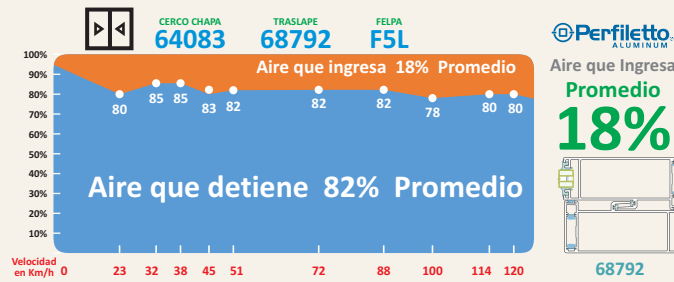
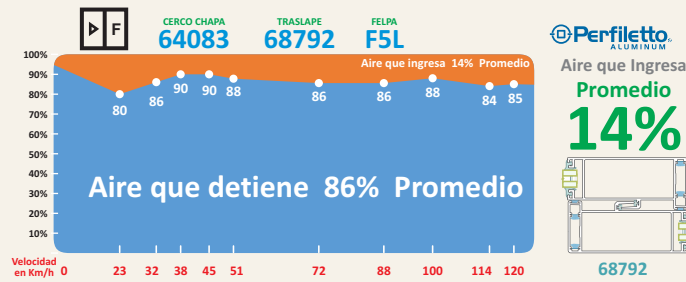
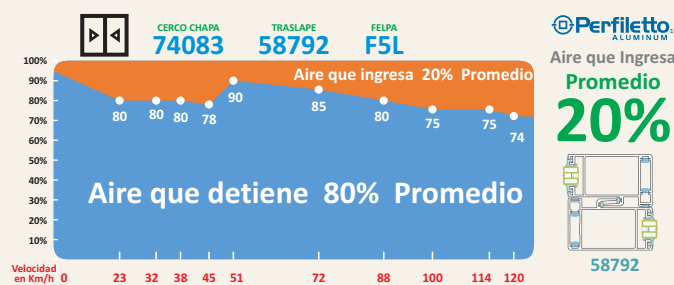
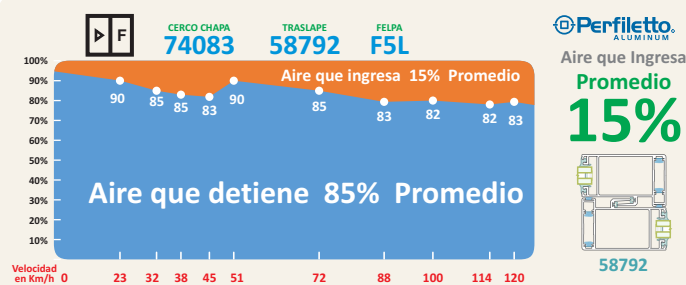

LÍNEA EXCLUSIVA PERFILETTO

RESISTENCIAS A VIENTOS

VENTANA
Prueba Realizada
30 Repeticiones de 1 Minuto c/u
A 120 Km/h
Medida 1.00 x 1.00 m
Dos Cristales 6 mm
LOS PERFILES SIN DEFORMACIÓN
CONSERVAN SU FUNCIONAMIENTO

PUERTA
Prueba Realizada
30 Repeticiones de 1 Minuto c/u
A 120 Km/h
Medida 2.00 X 2.10 m
Dos Cristales 6 mm
LOS PERFILES SIN DEFORMACIÓN
CONSERVAN SU FUNCIONAMIENTO

6 mm

6 mm

6 mm

18 mm

Más Hermética al: **Viento, Ruido y Temperatura** por su Felpa de 11 mm

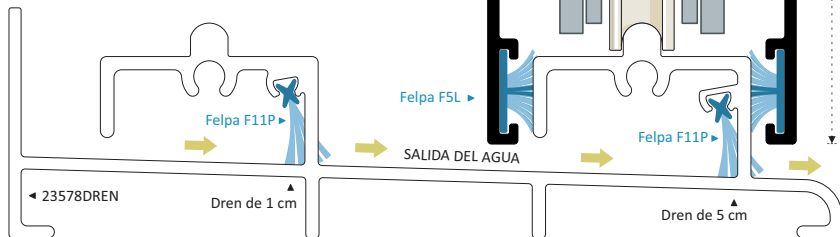
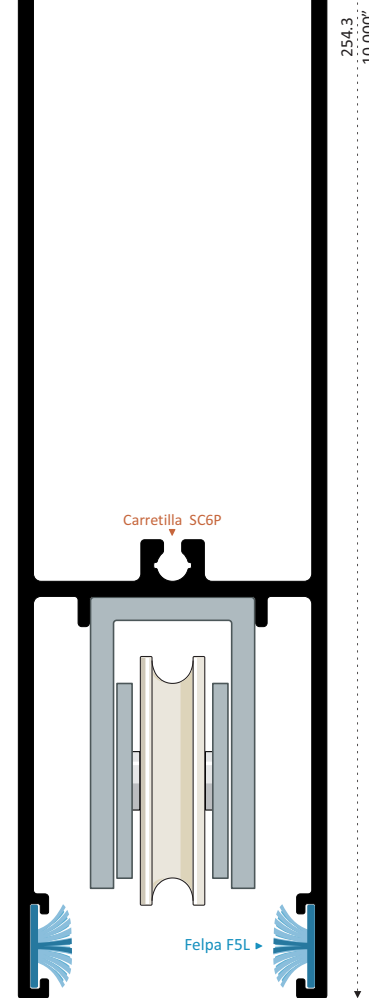
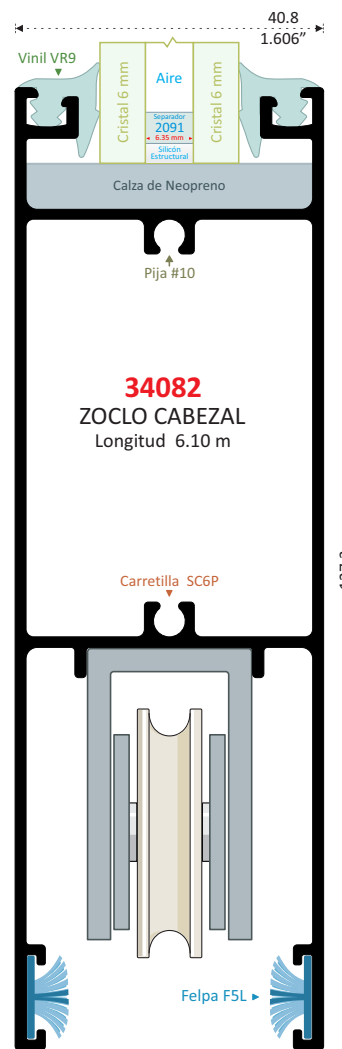
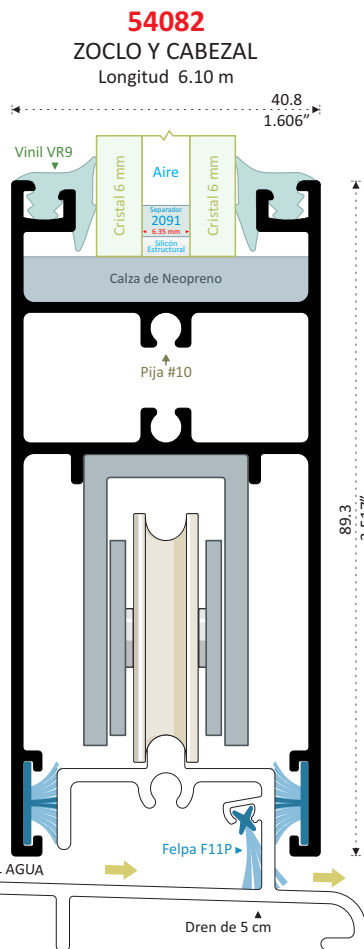
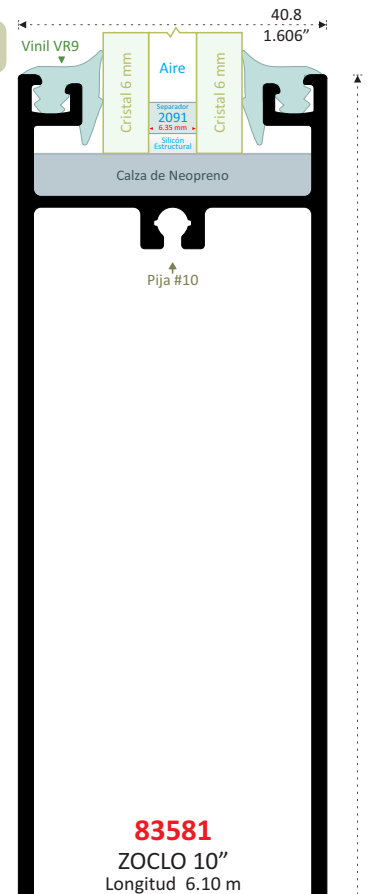
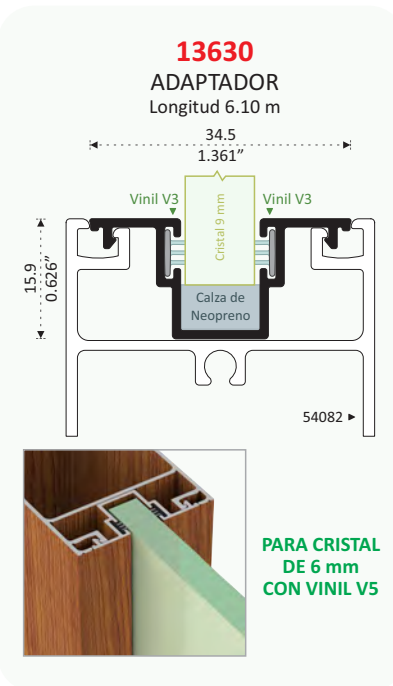
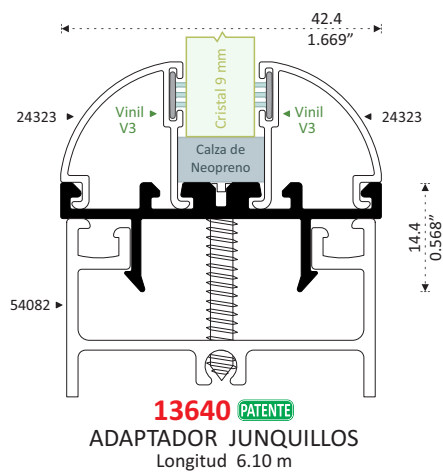
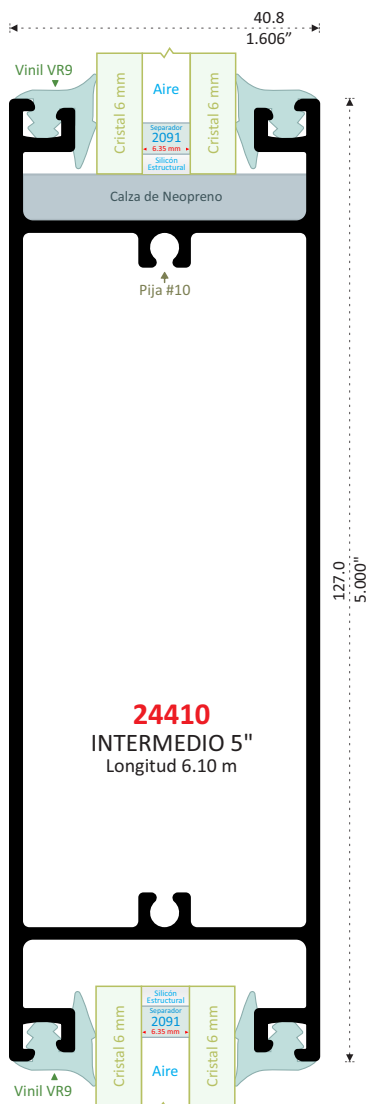
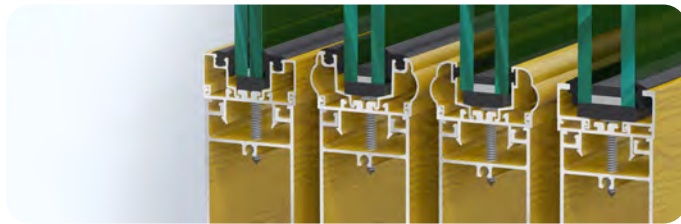

Más Hermética al: **Viento, Ruido y Temperatura** por su Felpa de 11 mm

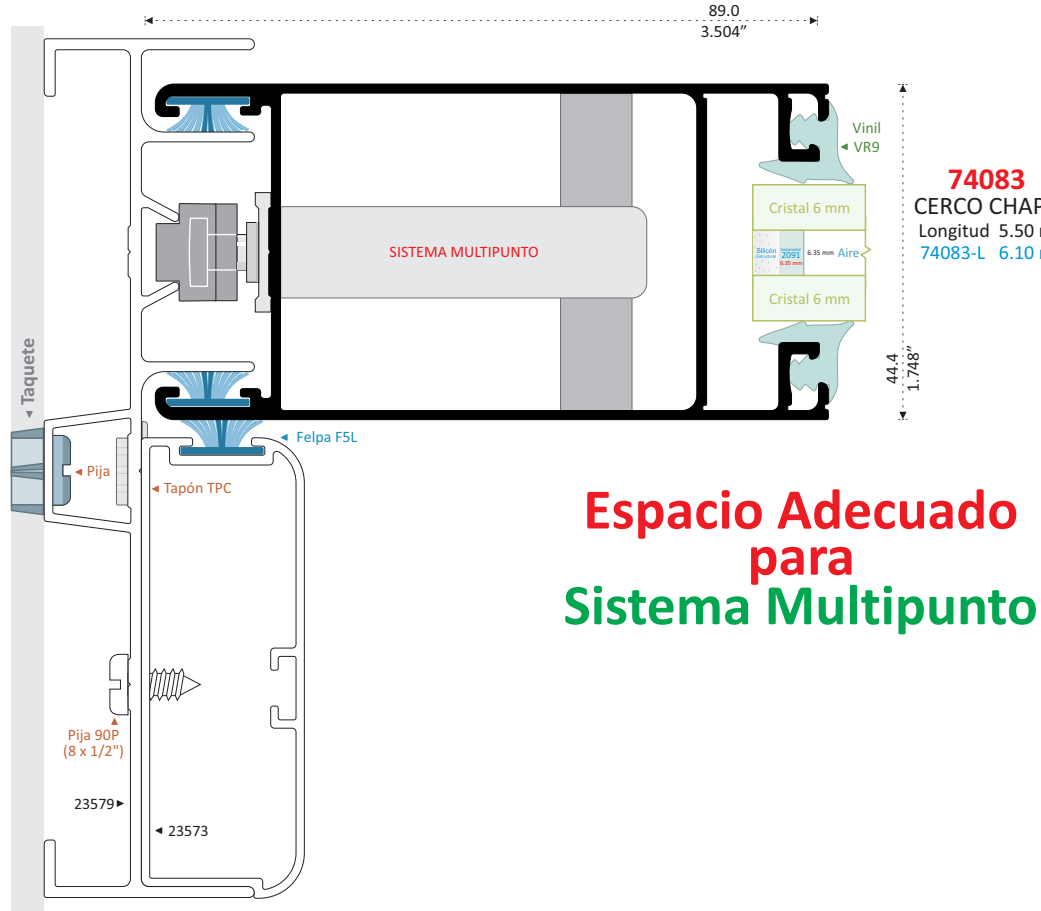

NUEVO
58792
TRASLAPE
Longitud 5.50 m

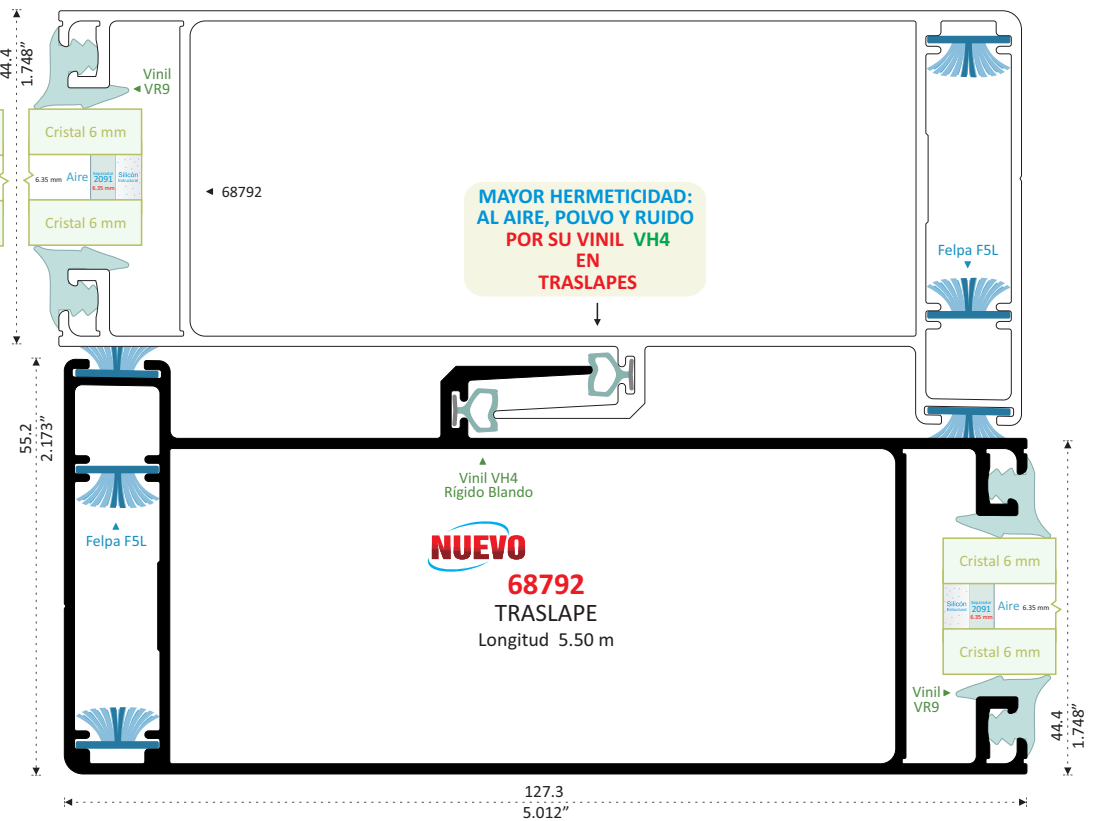
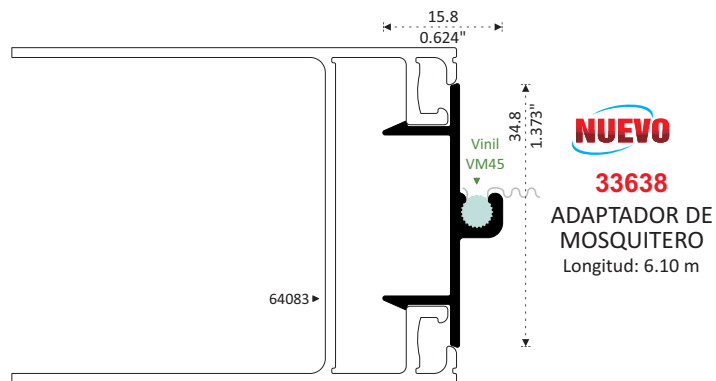
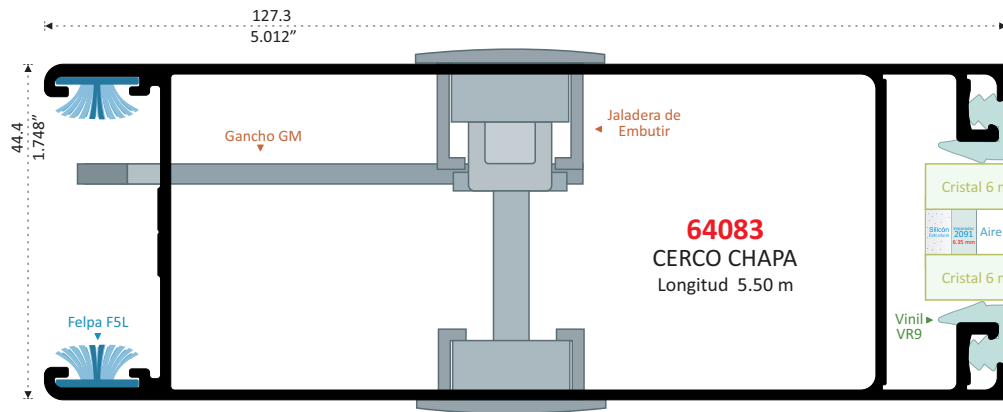
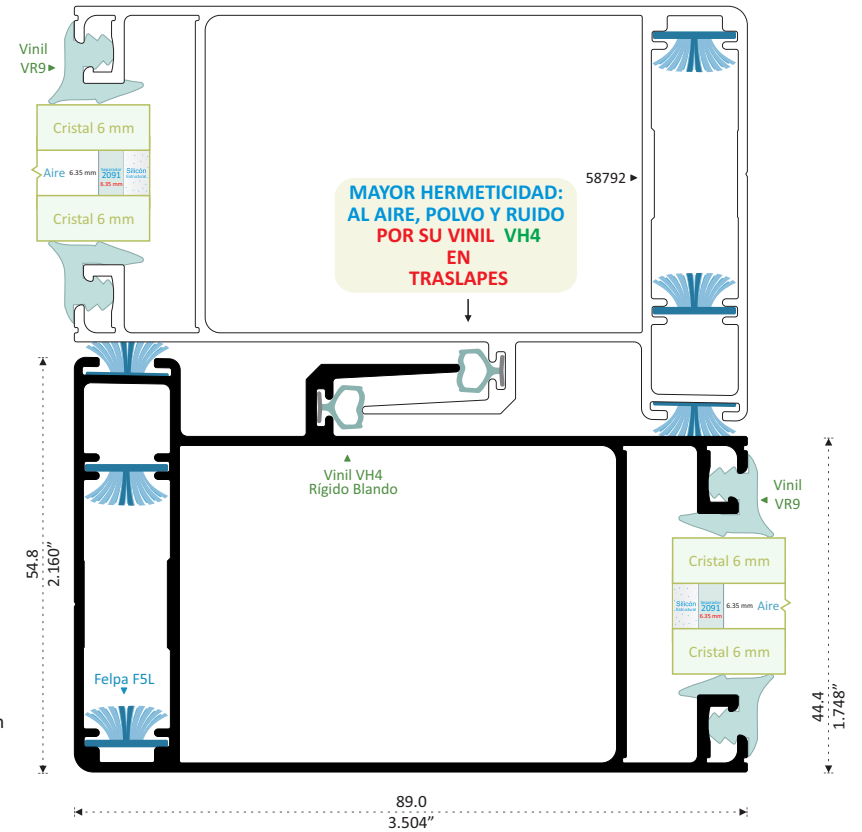

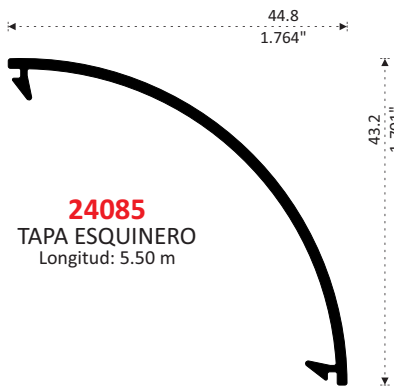
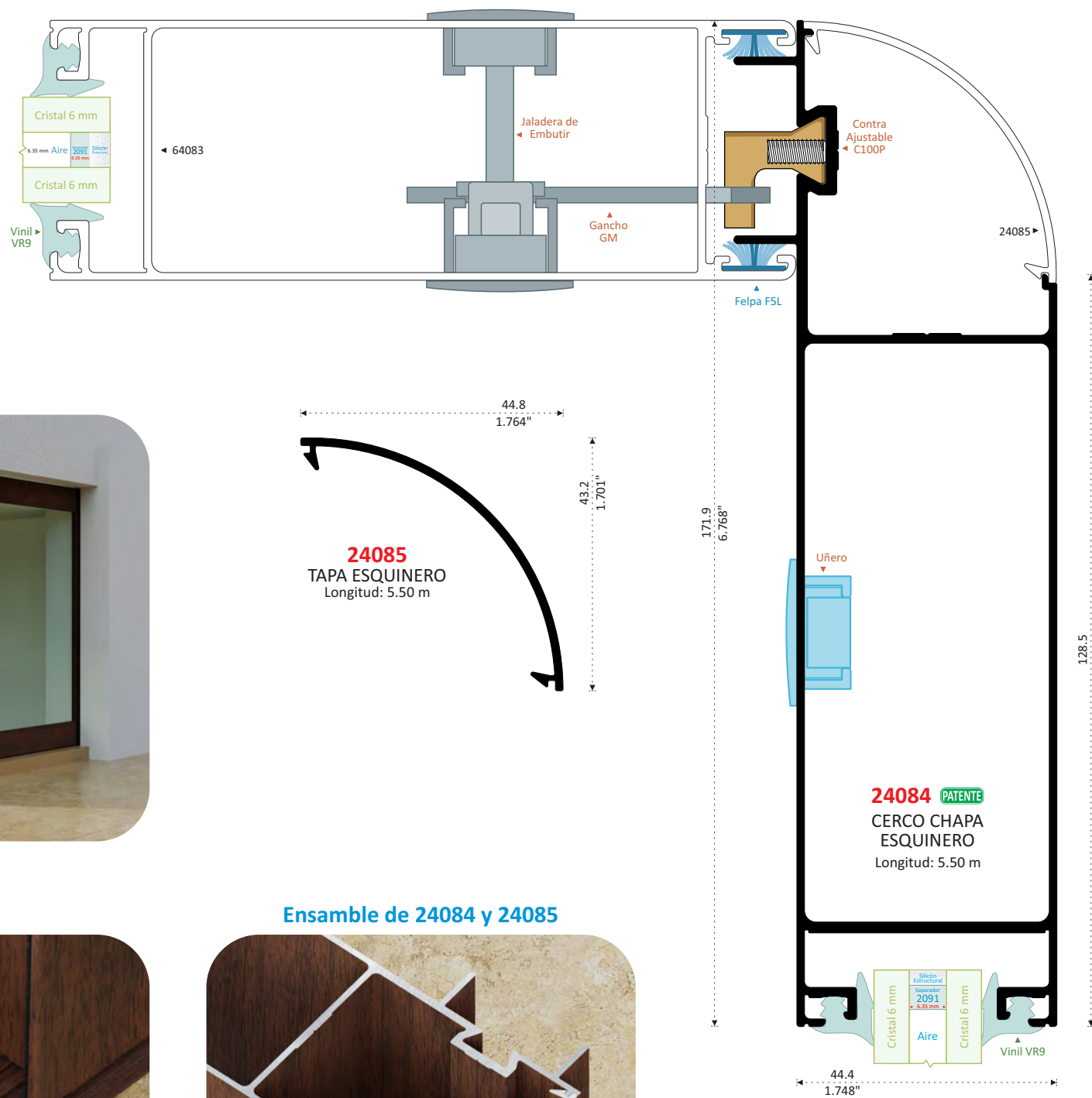

Ensamble de 24084 y 24085



Aumenta la Hermeticidad Acústica, Colocando Vinil por Ambos Lados

SEPARADOR DE 1/2" (12.7mm)

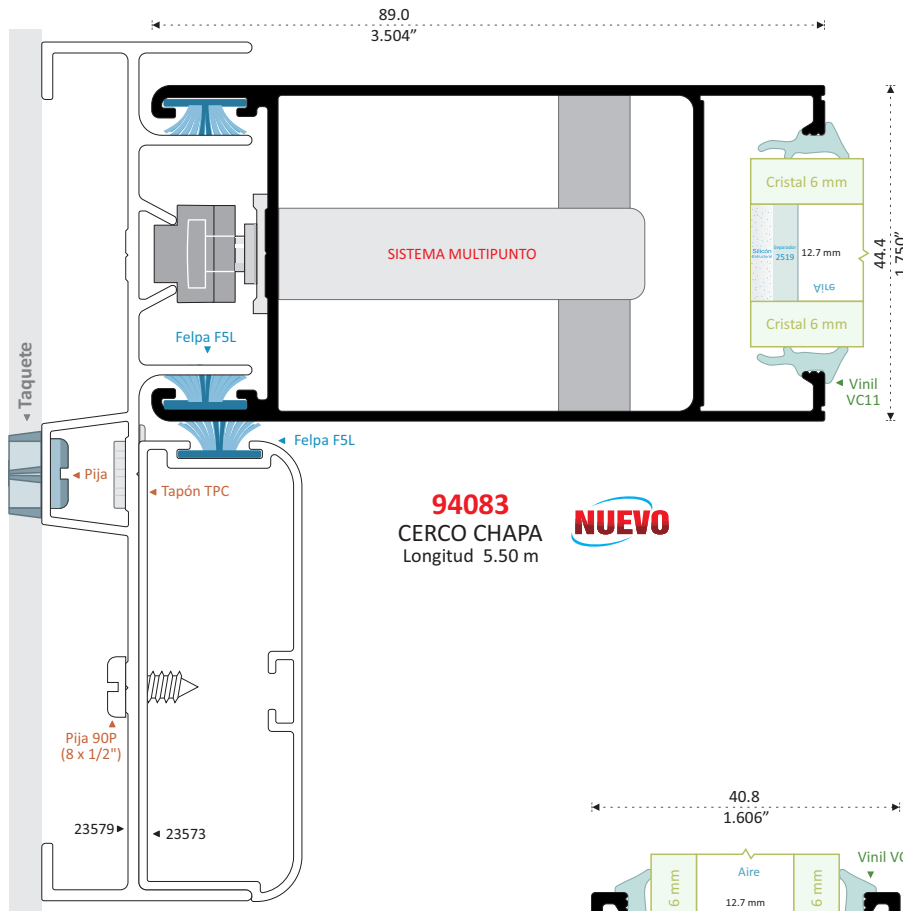

94083
CERCO CHAPA
Longitud 5.50 m
NUEVO

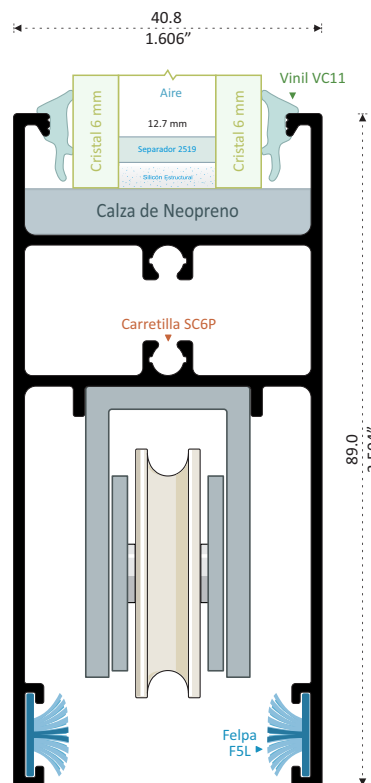

NUEVO
94082
ZOCLO Y CABEZAL
Longitud 6.10 m

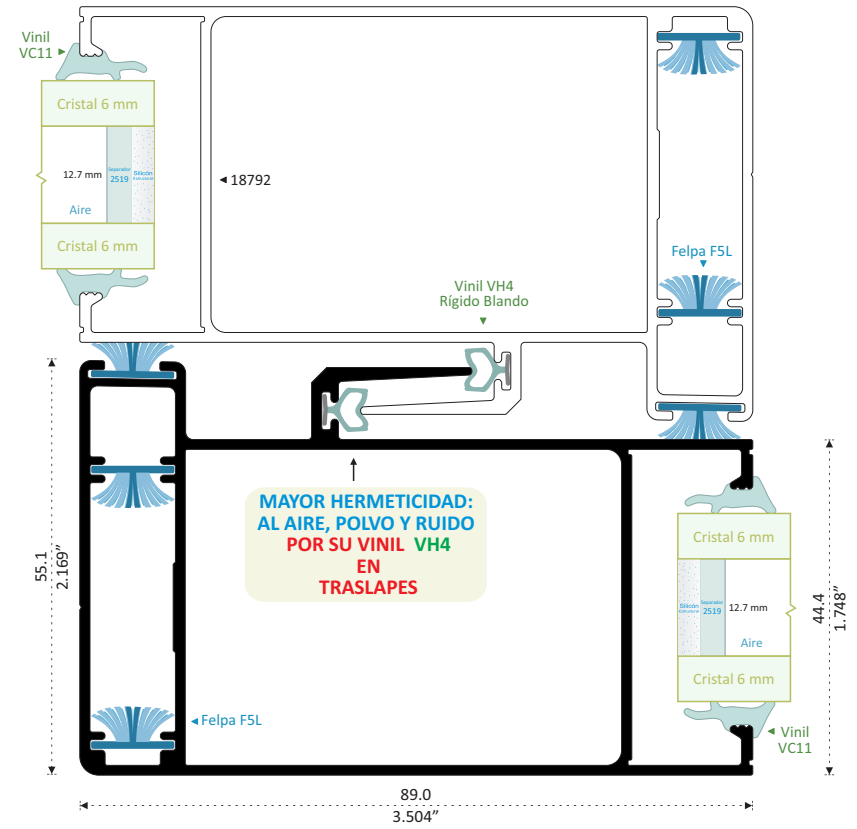

**MAYOR HERMETICIDAD:
AL AIRE, POLVO Y RUIDO
POR SU VINIL VH4
EN
TRASLAPES**

98792
TRASLAPE
Longitud 5.50 m
98792-C 4.60 m
NUEVO

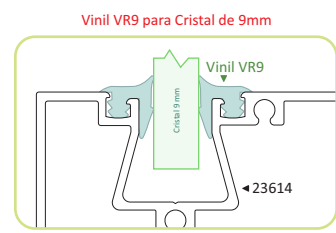
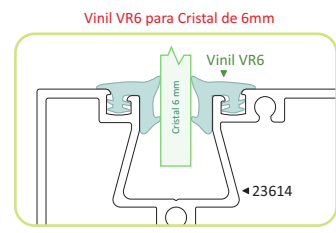
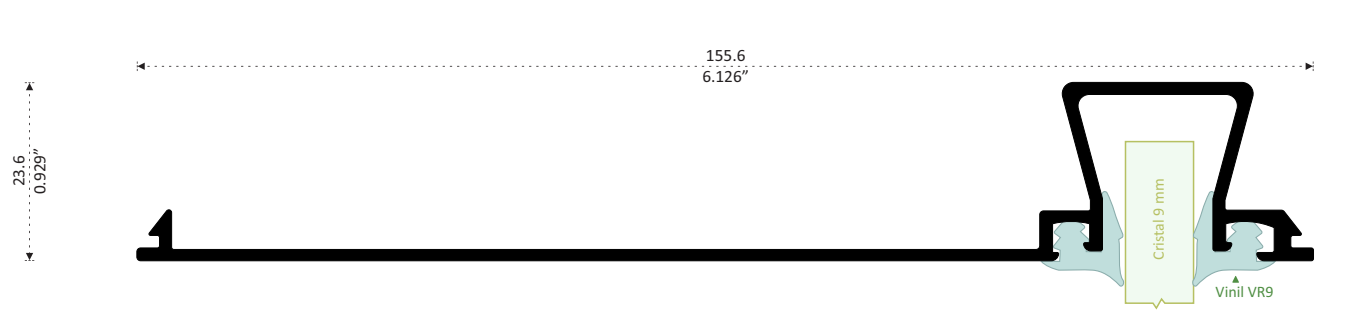
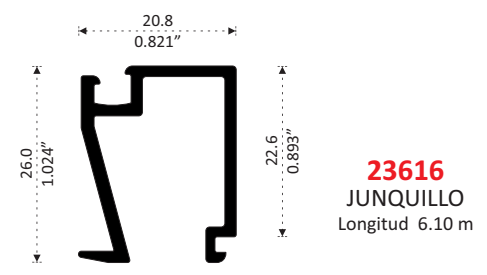
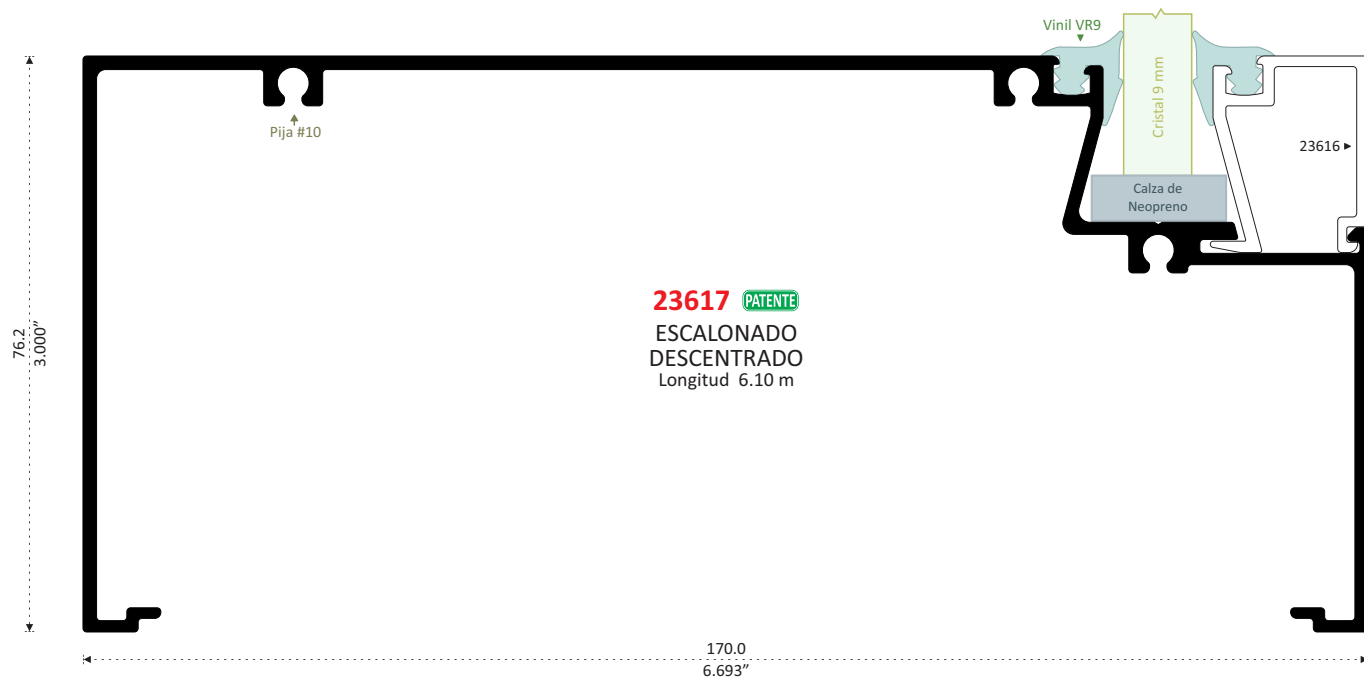
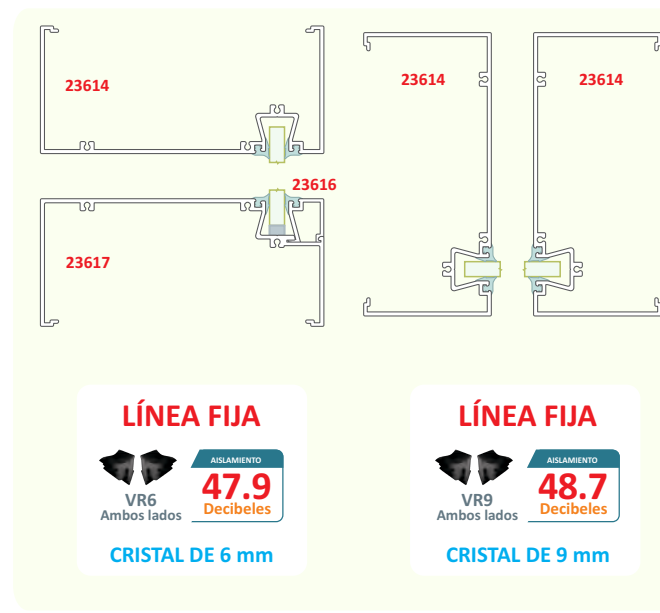
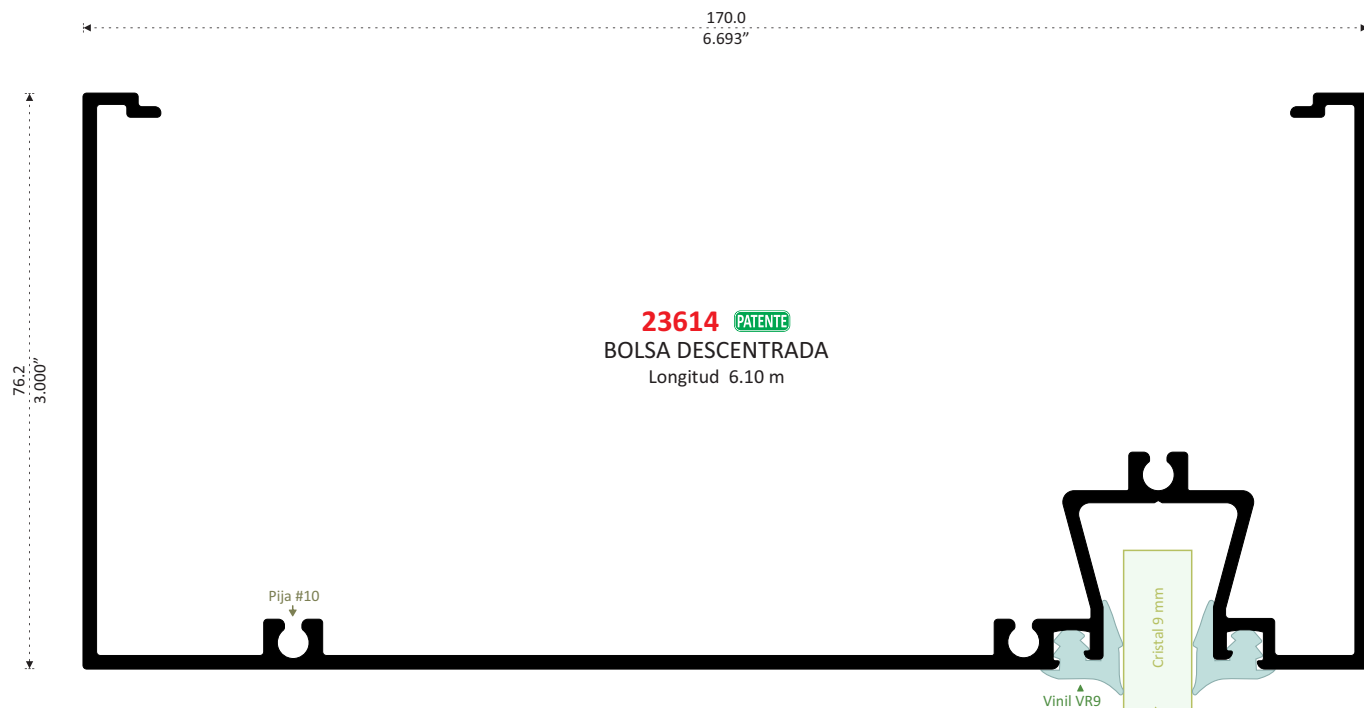

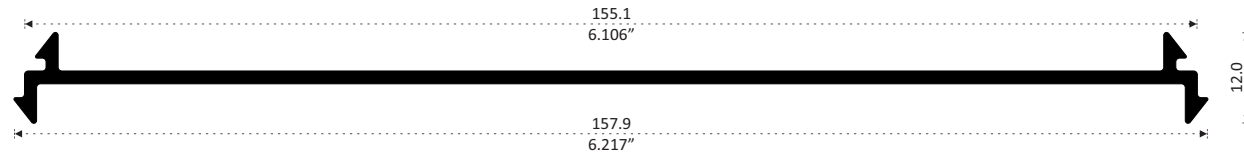

23618
MOLDURA UNIÓN
Longitud: 6.10 m

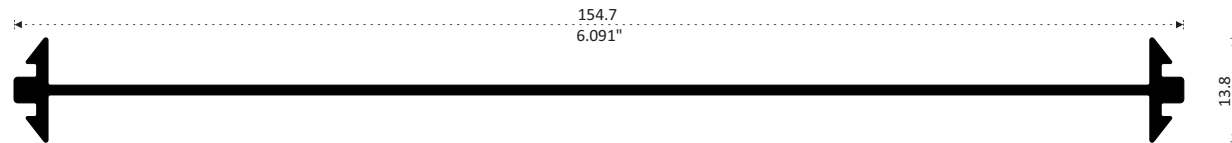
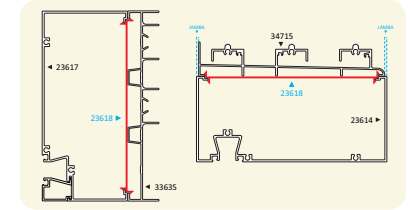

23630
MOLDURA UNIÓN
Longitud 6.10 m

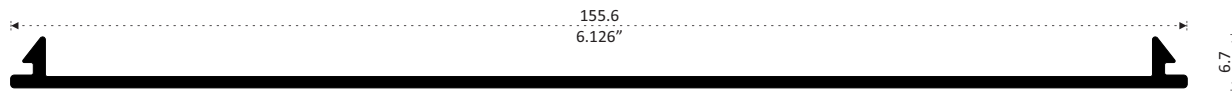
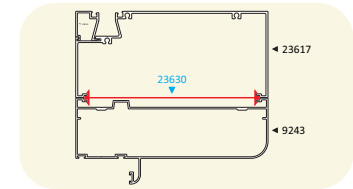

23613
TAPA LISA
Longitud: 6.10 m

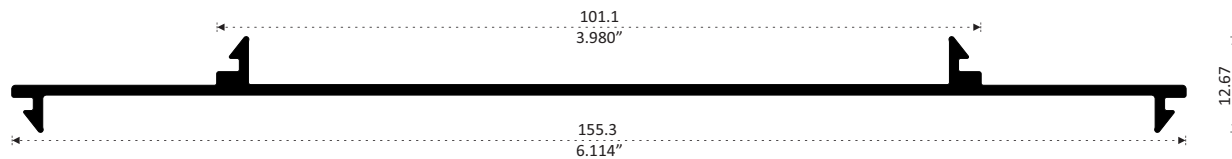

23609
MOLDURA UNIÓN
Longitud 6.10 m

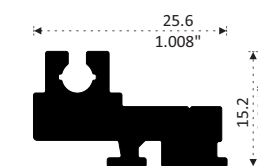
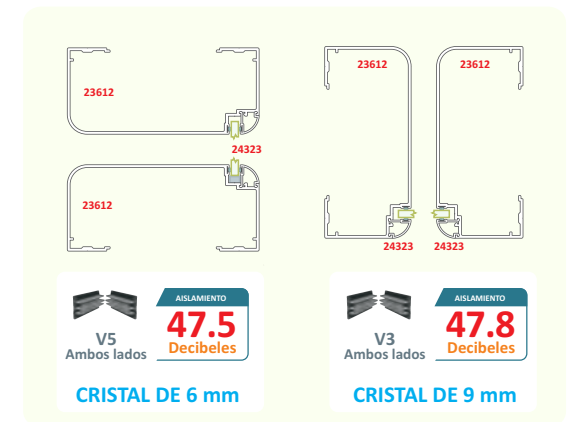
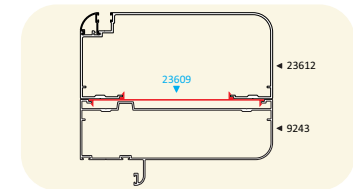

12538
BARRA DE ARMADO
Longitud 3.03 m

- PERFILES:
- MB33 9187
 - MB57 19187
 - MB107 412596

CORREDIZA SERIE 100 TRIPLE HERMÉTICA

PRUEBAS EN NUESTRO CENTRO DE INVESTIGACIÓN Y DESARROLLO Armadas con Perfiles y Complementos Esenciales 100% Perfiletto

AI SLAM IENTO ACÚSTICO

REALIZADO CON 120 DECIBELES AL EXTERIOR
MEDIDA 1.00 x 1.00 m

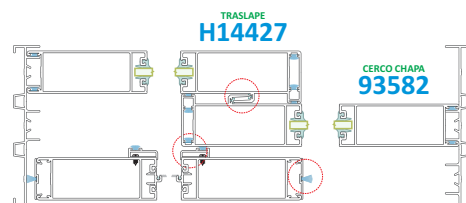
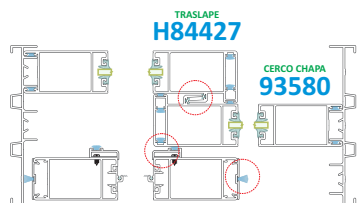

LÍNEA EXCLUSIVA PERFILETTO

LÍNEA EXCLUSIVA PERFILETTO

PERMEABILIDAD AL AGUA DURANTE 20 MINUTOS

VENTANA MEDIDA 1.00 x 1.00 m

VELOCIDAD KM/H	Agua	Aire
20	50%	50%
40	50%	50%
60	50%	50%
80	50%	50%
100	50%	50%
120	60%	40%

SIN MOSQUITERO
Sin Filtraciones

MOSQUITERO CORREDIZO INTERIOR
Sin Filtraciones

MOSQUITERO CORREDIZO EXTERIOR

VELOCIDAD KM/H	Agua	Aire	Litros Filtrados
20	50%	50%	0.23
40	50%	50%	0.62
60	50%	50%	1.95
80	50%	50%	2.74
100	50%	50%	4.86
120	60%	40%	5.70

MOSQUITERO CORREDIZO EXTERIOR
OCASIONA ALTA FILTRACIÓN DE AGUA

PUERTA MEDIDA 1.00 x 1.00 m

VELOCIDAD KM/H	Agua	Aire
20	50%	50%
40	50%	50%
60	50%	50%
80	50%	50%
100	50%	50%
120	60%	40%

SIN MOSQUITERO
Sin Filtraciones

MOSQUITERO CORREDIZO INTERIOR
Sin Filtraciones

MOSQUITERO CORREDIZO EXTERIOR

VELOCIDAD KM/H	Agua	Aire	Litros Filtrados
20	50%	50%	0.26
40	50%	50%	0.69
60	50%	50%	2.00
80	50%	50%	2.83
100	50%	50%	4.97
120	60%	40%	5.79

MOSQUITERO CORREDIZO EXTERIOR
OCASIONA ALTA FILTRACIÓN DE AGUA

PERMEABILIDAD AL VIENTO Medida 1.00 x 1.00 m

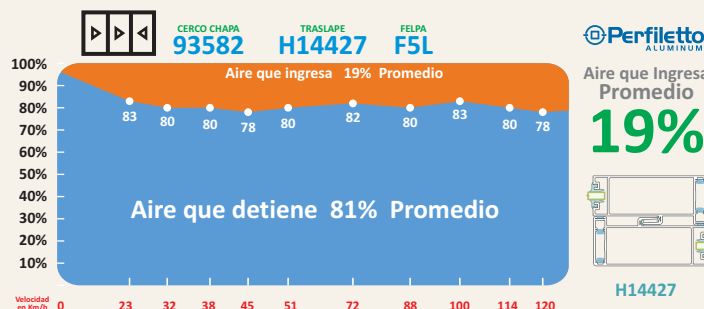
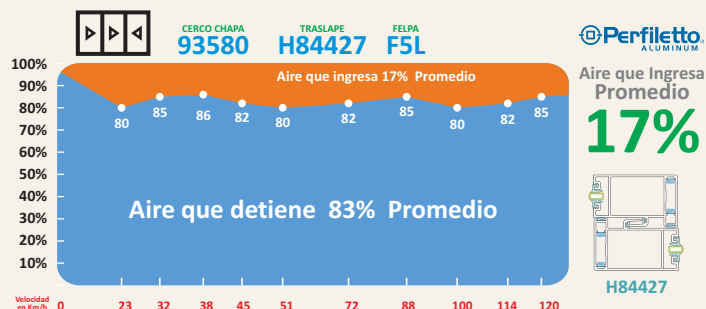

LÍNEA EXCLUSIVA PERFILETTO

RESISTENCIAS A VIENTOS

VENTANA

Prueba Realizada
30 Repeticiones de 1 Minuto c/u
A 120 Km/h
Medida 1.00 x 1.00 m
Cristal 6 mm

LOS PERFILES SIN DEFORMACIÓN
CONSERVAN SU FUNCIONAMIENTO

PUERTA

Prueba Realizada
30 Repeticiones de 1 Minuto c/u
A 120 Km/h

Medida 2.00 X 2.10 m
Cristal 6 mm
LOS PERFILES SIN DEFORMACIÓN
CONSERVAN SU FUNCIONAMIENTO

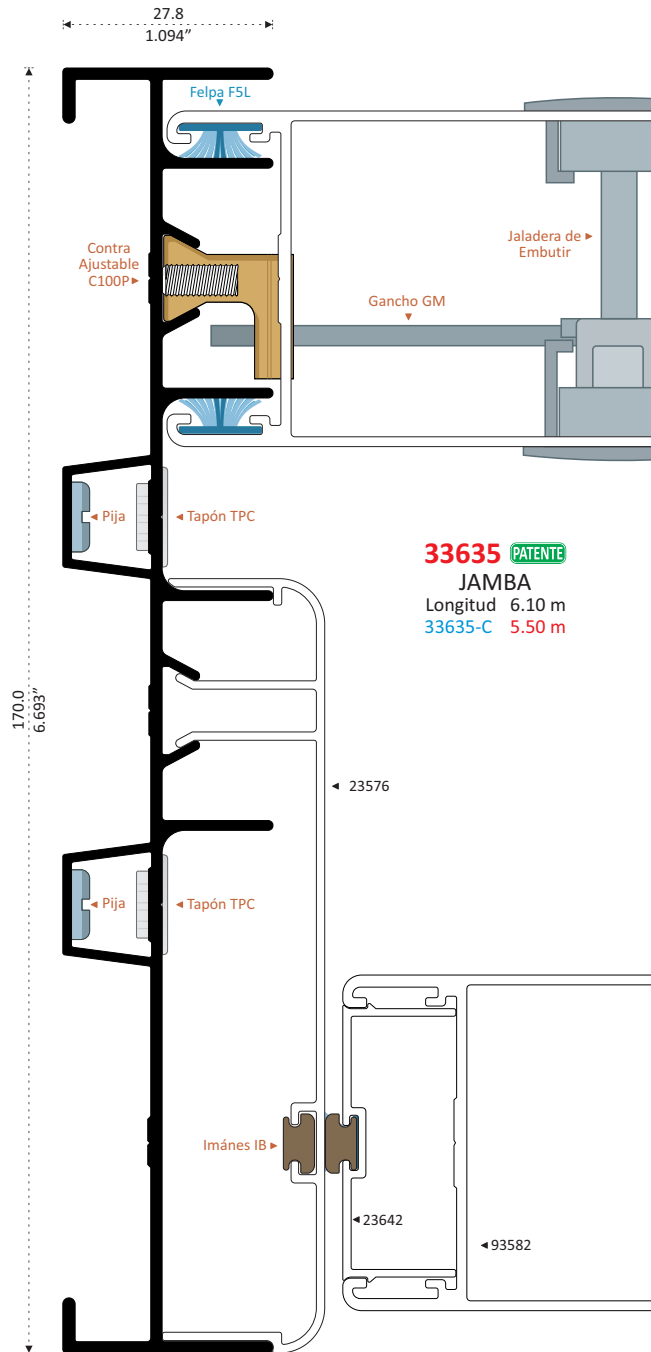

34715 **PATENTE**
RIEL Y CABEZAL
Longitud 6.10 m
34715-C 3.05 m

34715DREN
Longitud 6.10 m

34715D-C
Longitud 3.05 m

Drenes cada 40 cm
sin Costo

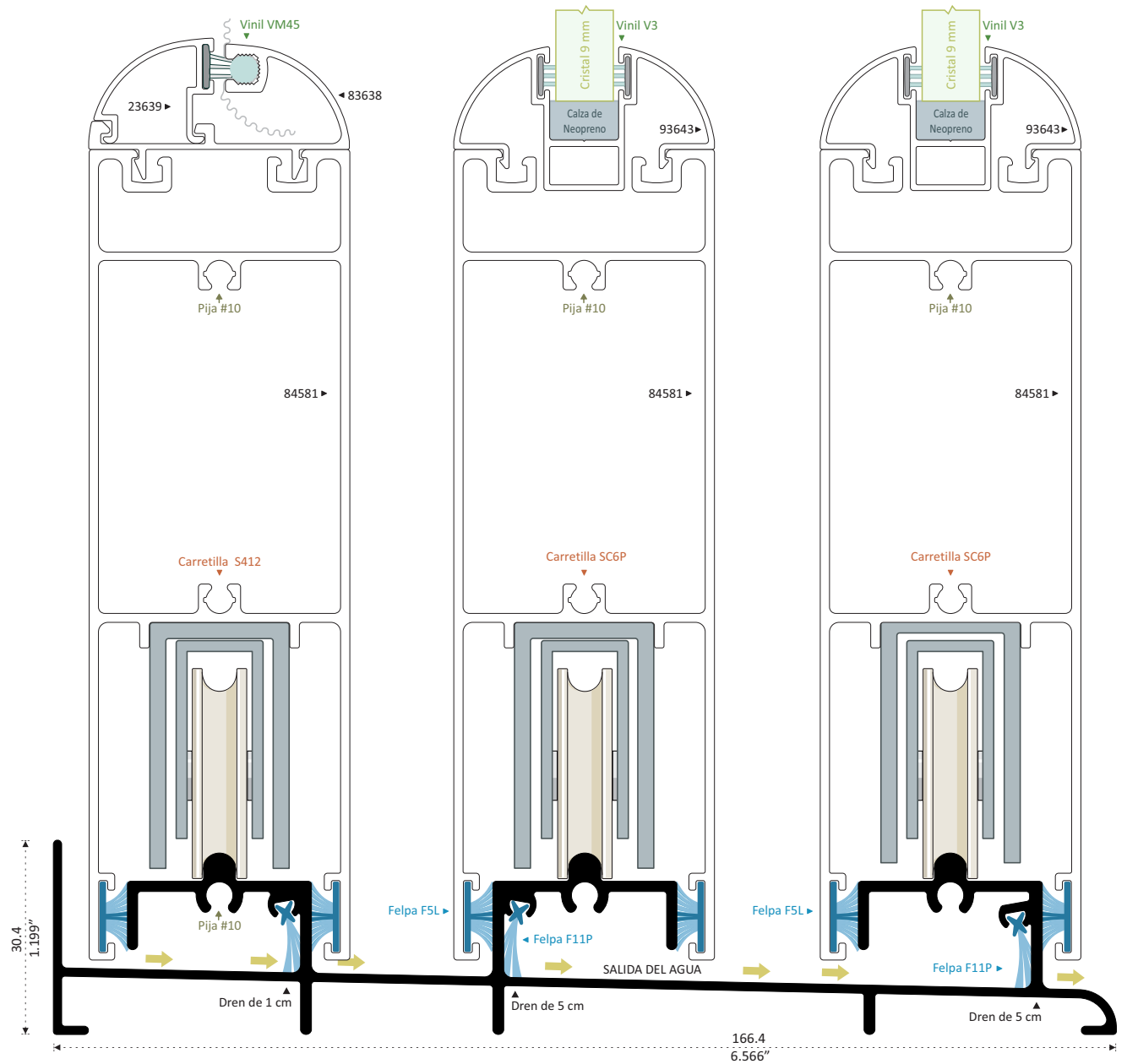

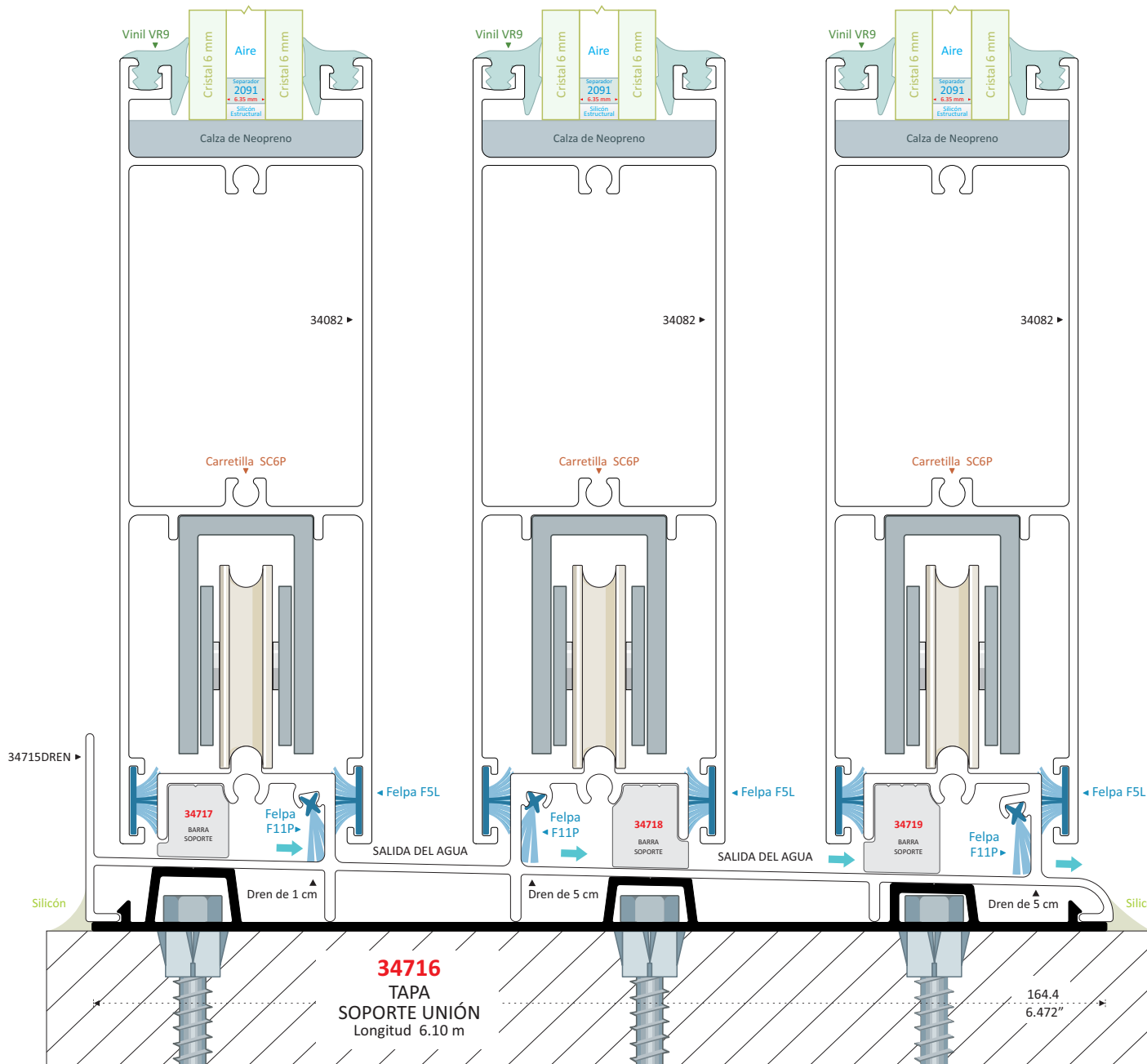

Fijación sin Perforaciones al Riel, Evitando Humedades

Fijación Reforzada que Soporta Alta Presión de Viento

Sistema Diseñado para Soportar hasta 250 kg por Hoja

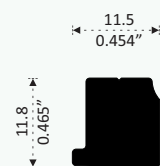

34717
BARRA SOPORTE 1
Longitud 6.10 m
Drenes de 1 cm cada 40 cm

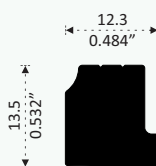

34718
BARRA SOPORTE 2
Longitud 6.10 m
Drenes de 5 cm cada 40 cm

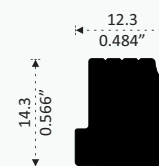

34719
BARRA SOPORTE 3
Longitud 6.10 m
Drenes de 5 cm cada 40 cm

BARRA SOPORTE CON DRENES

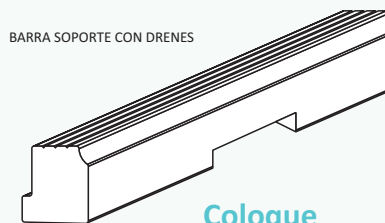

Coloque Barra Soporte cuando el Peso Exceda 60 Kg. por cada Hoja (Fija ó Móvil)

Barras para Cada Hoja Móvil

34716
TAPA SOPORTE UNIÓN
Longitud 6.10 m

10.3 mm (0.407 inches) height
164.4 mm (6.472 inches) width

CUBIERTAS



**RESALTAN LA BELLEZA
DE LA LINEA**

23576
CUBIERTA
Longitud 6.10 m

23575
CUBIERTA
Longitud 6.10 m

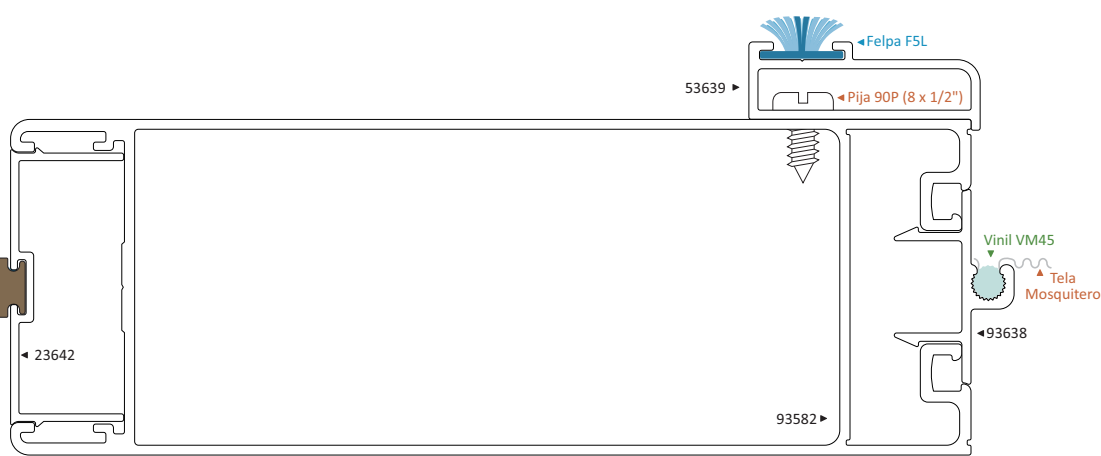
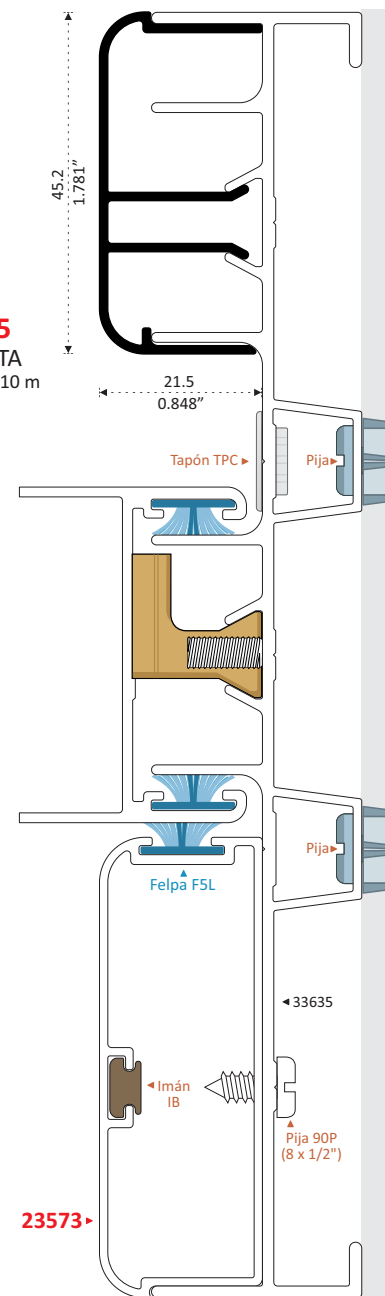
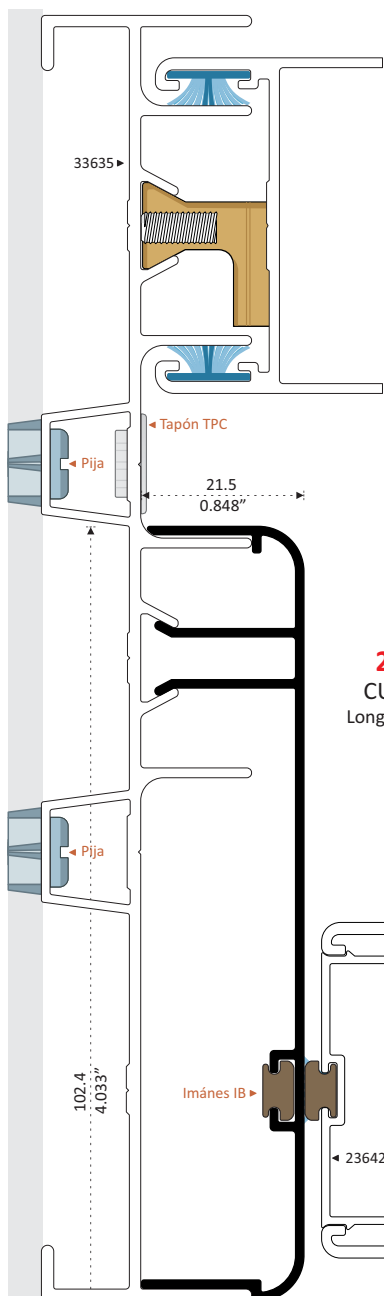

23573

**VISTA ELEGANTE
POR SU VINIL OCULTO**

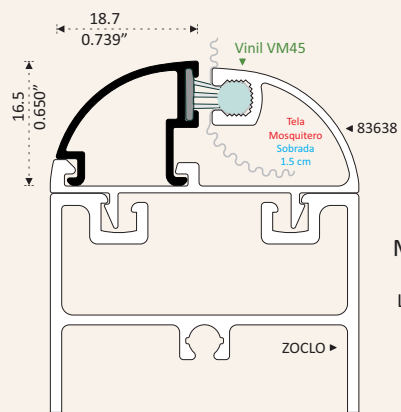

23639
JUNQUILLO
MOSQUITERO
CURVO
Longitud 6.10 m



**Estrías en Perfil y Vinil
Logrando Mayor Tensión
a la Tela Mosquitero
Sin Salirse de su Lugar**

NUEVO

83638
ADAPTADOR
MOSQUITERO
CURVO
Longitud 6.10 m

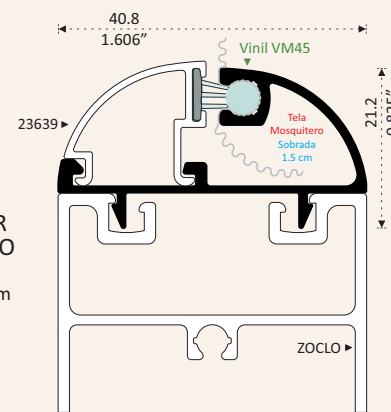

Dos Hojas Corredizas y Una con Mosquitero

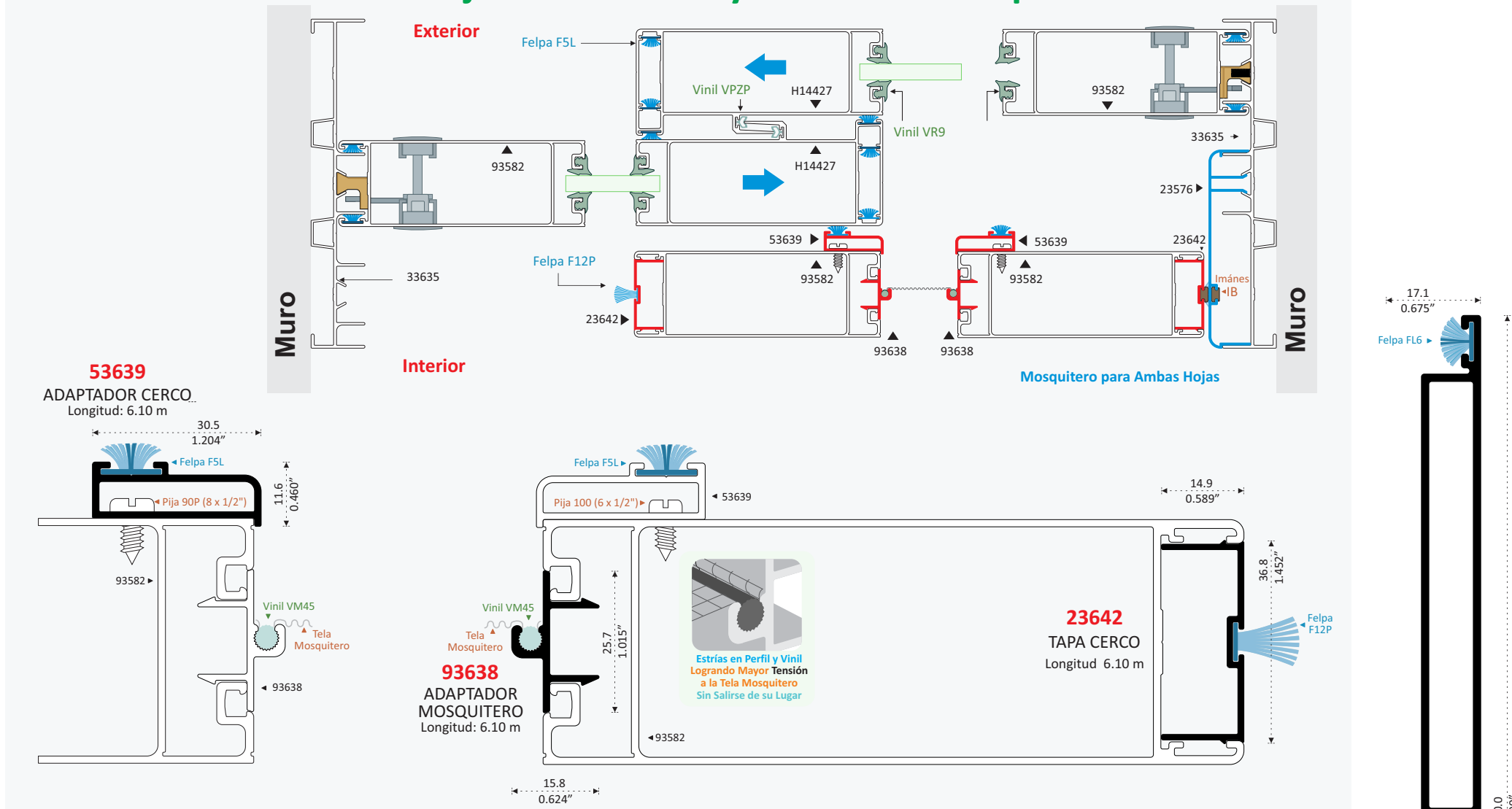

Corrediza Triple Ocultable en Muro

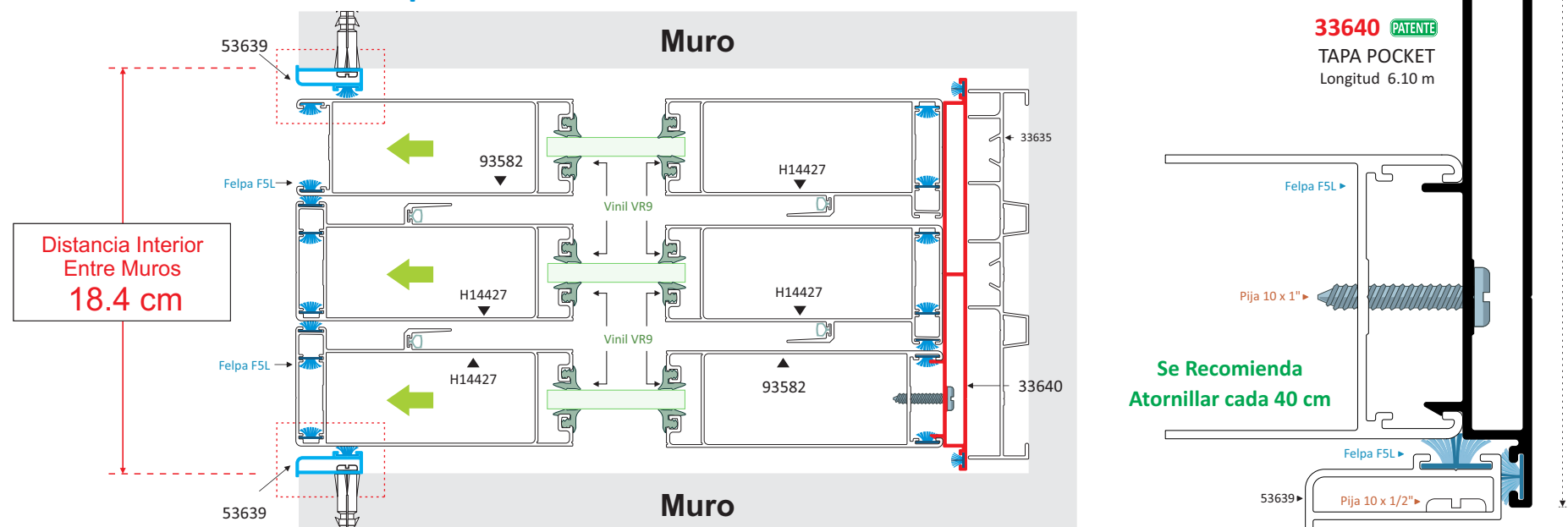



Armar El Marco de la Hoja con Escuadra de Botón Hasta 20 Kg.



Más de 20 Kg. Armar con Escuadra de Aluminio

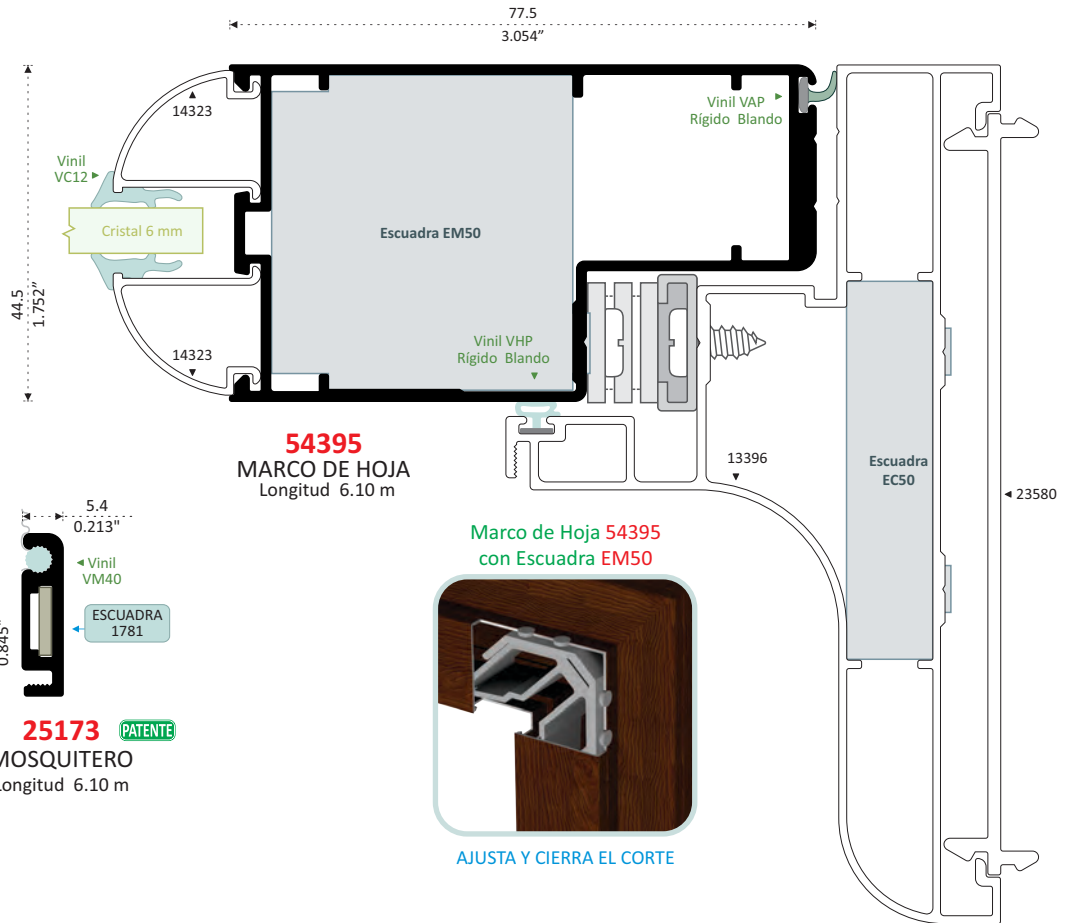

54395 MARCO DE HOJA
Longitud 6.10 m

Vinil VC12
Cristal 6 mm
Escuadra EM50
Vinil VAP Rígido Blando
Vinil VHP Rígido Blando
Escuadra EC50
23580

25173 PATENTE MOSQUITERO
Longitud 6.10 m

5.4 0.213"
Vinil VM40
ESCUADRA 1781
21.4 0.845"

Marco de Hoja 54395 con Escuadra EM50

AJUSTA Y CIERRA EL CORTE

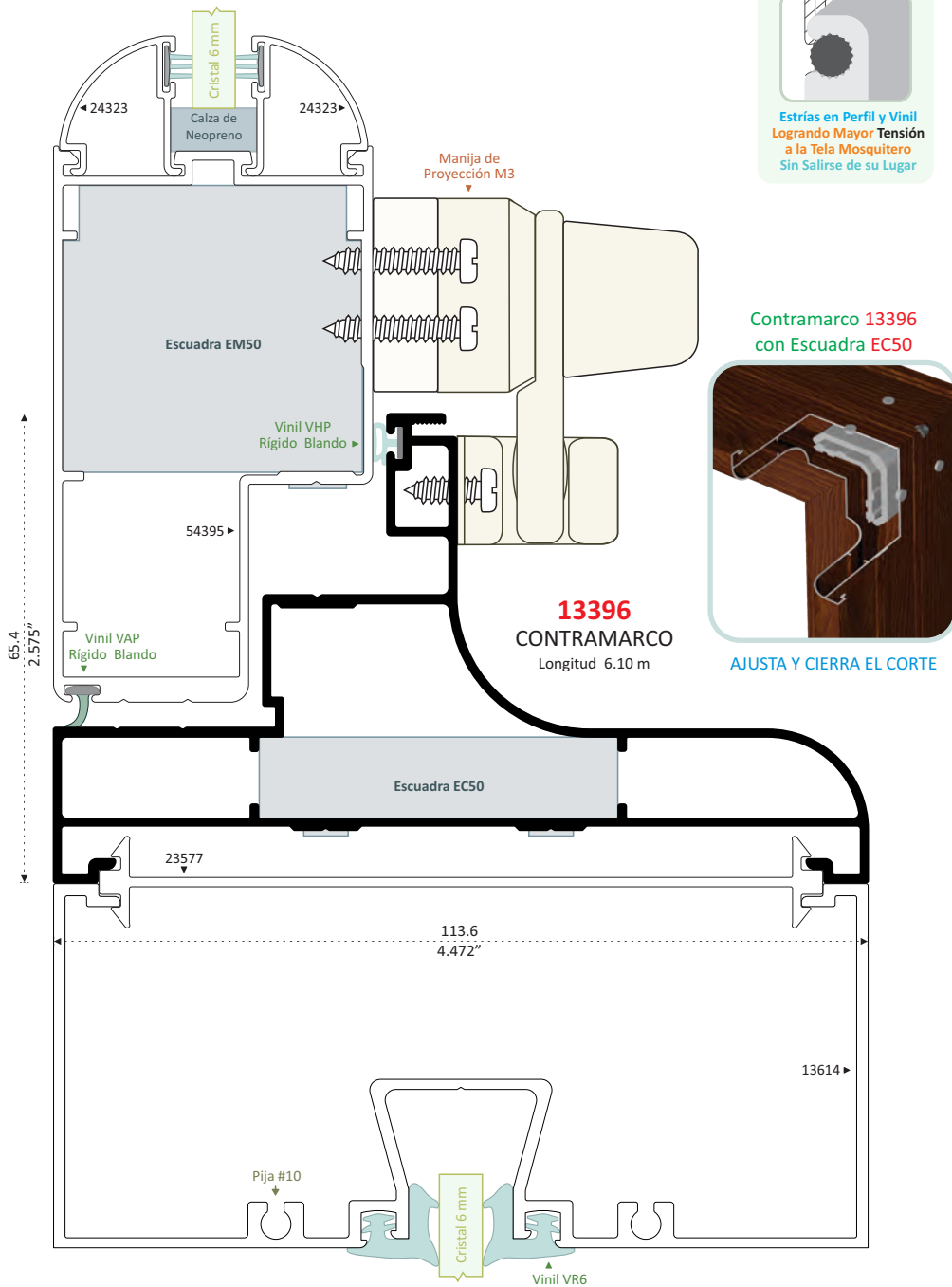



Manija de Proyección M3
Escuadra EM50
Calza de Neopreno
Cristal 6 mm
24323
Vinil VHP Rígido Blando
54395
Vinil VAP Rígido Blando
13396
CONTRAMARCO
Longitud 6.10 m
Escuadra EC50
23577
113.6 4.472"
13614
Pija #10
Cristal 6 mm
Vinil VR6

Estrías en Perfil y Vinil Logrando Mayor Tensión a la Tela Mosquitero Sin Salirse de su Lugar

Contramarco 13396 con Escuadra EC50

AJUSTA Y CIERRA EL CORTE

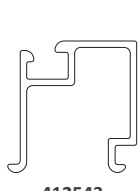
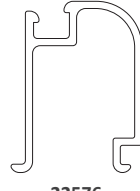
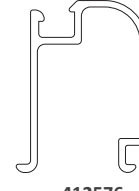
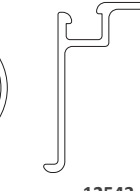
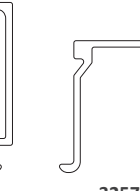
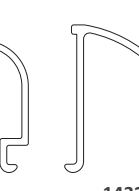
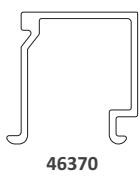
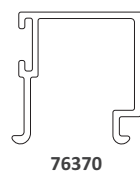
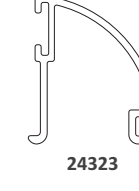
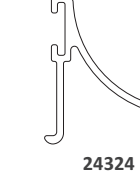
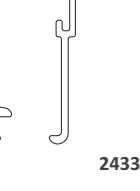
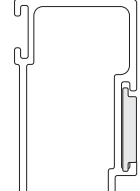
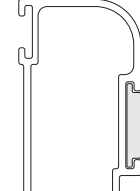
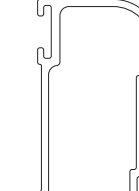
JUNQUILLOS PUERTA MULTIDISEÑOS

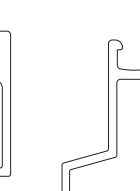
					
412543	22576	412576	12543	32576	14323
					
46370	76370	24323	24324	24331	
					
24327	24328	24330	22603	12604	

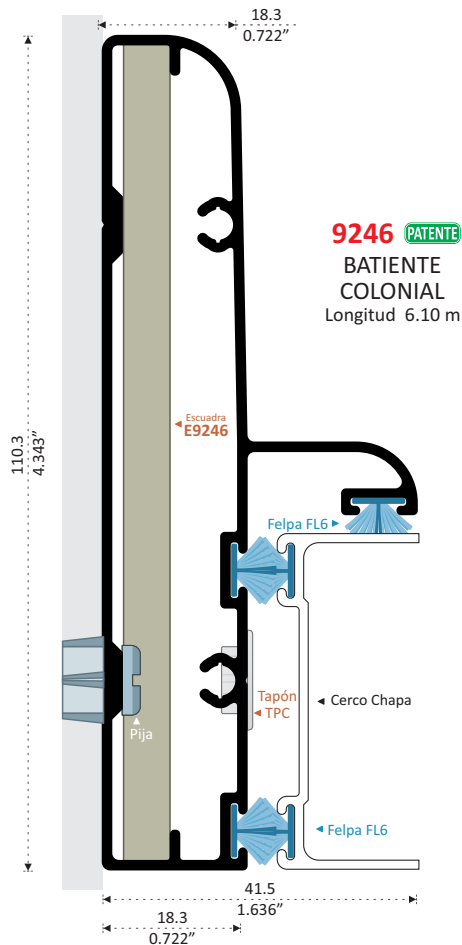

9242
BATIENTE COLONIAL
 Longitud 6.10 m

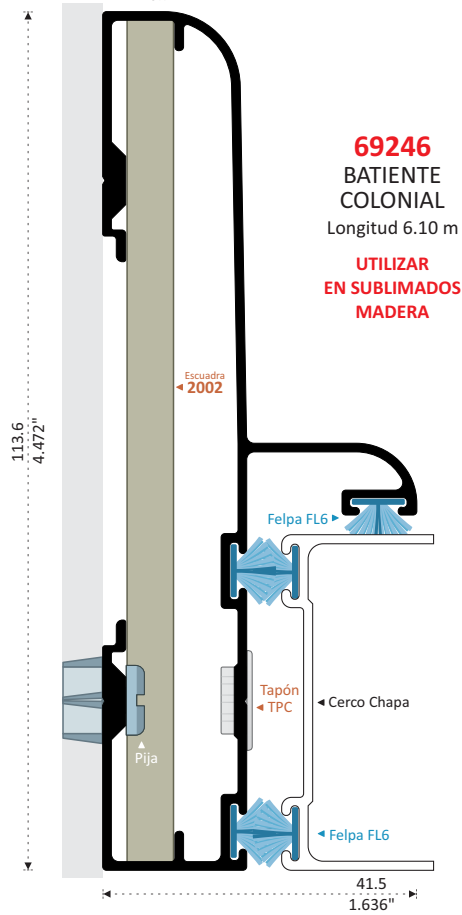
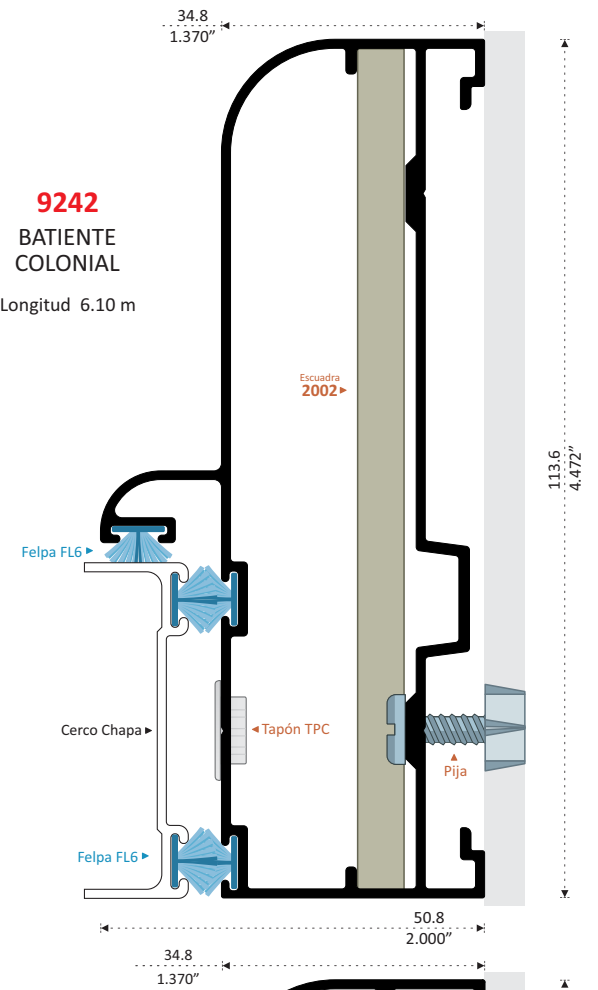

19242
BATIENTE COLONIAL
 Longitud 6.10 m

UTILIZAR EN SUBLIMADOS MADERA

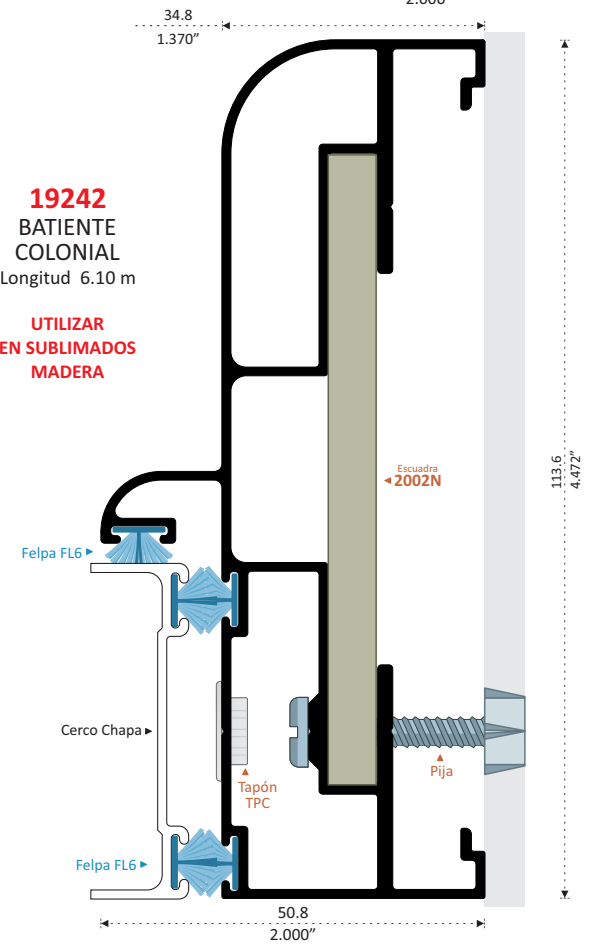



8243 PATENTE
CANAL BISAGRA HIDRÁULICA
Longitud 6.10 m

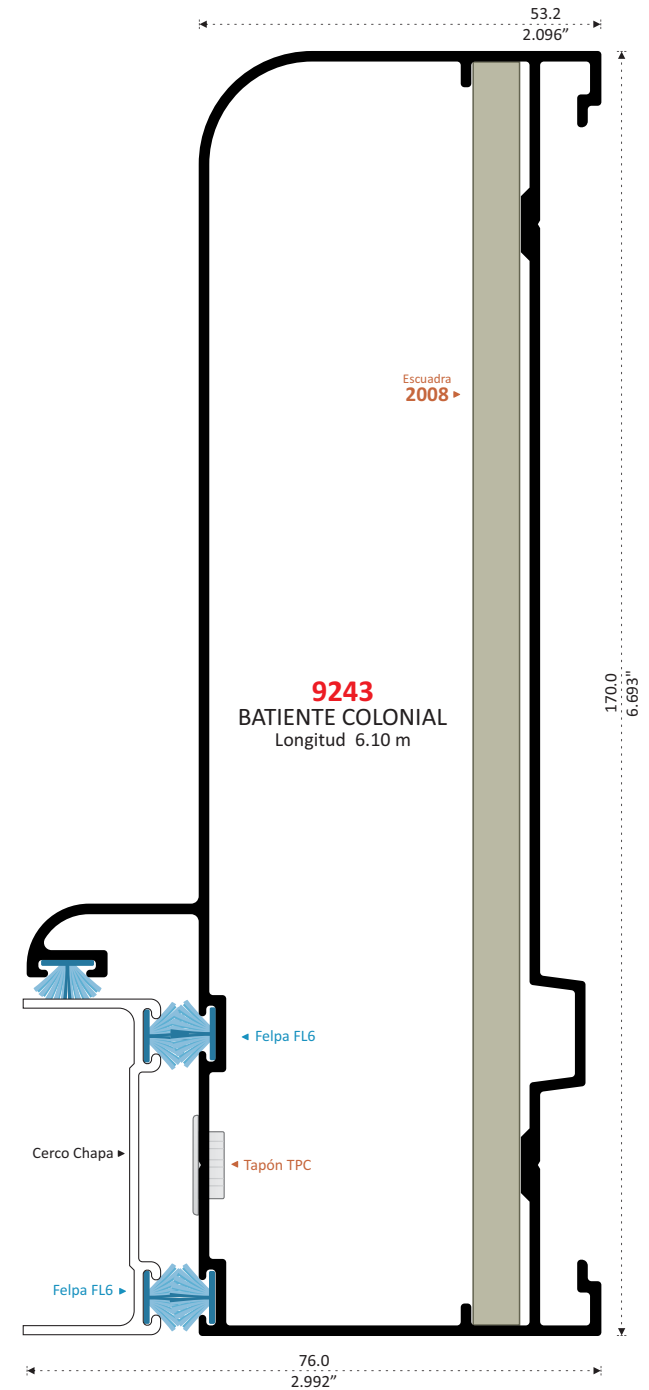



14386
CANAL BISAGRA
Longitud 6.10 m

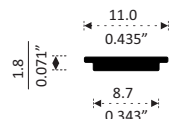
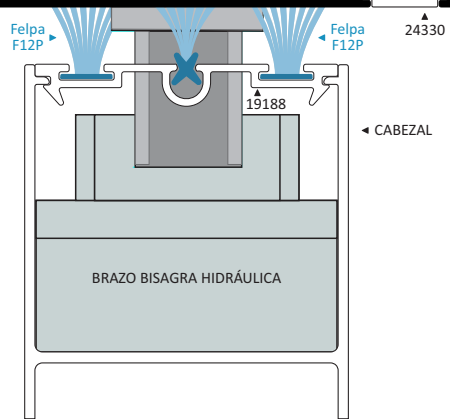

24330 PATENTE
BARRA MARQUETERÍA
Longitud: 6.10 m

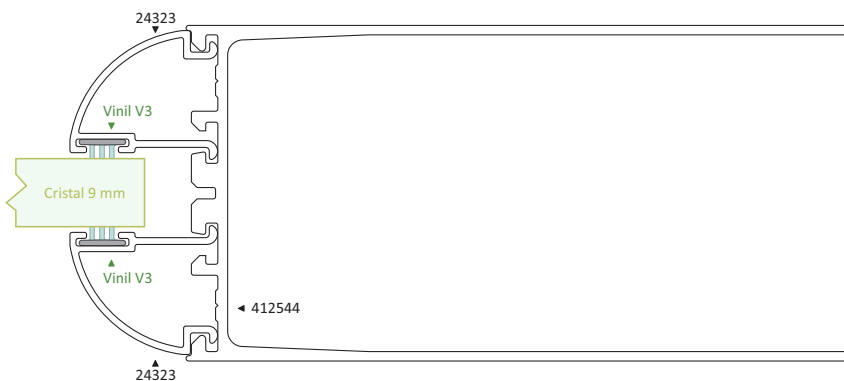

5117
BATIENTE DESLIZABLE
Longitud 6.10 m

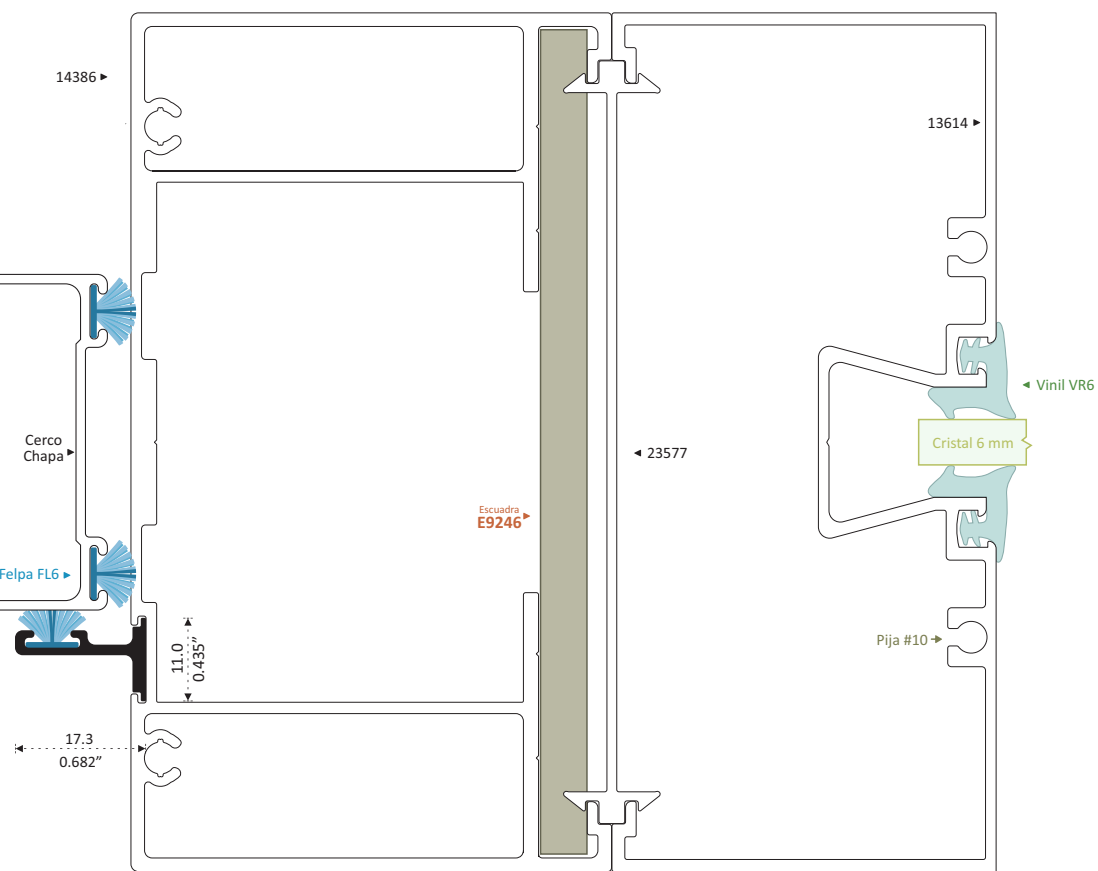

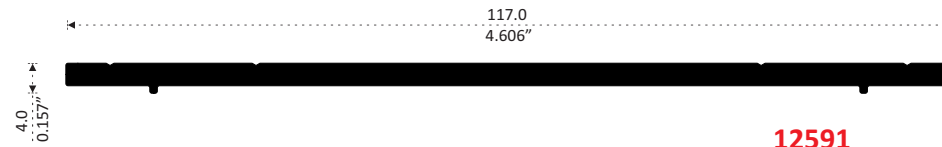

12591
TAPA BISAGRA
Longitud 6.10 m Clave 3125 33 cm

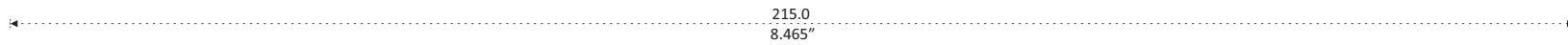

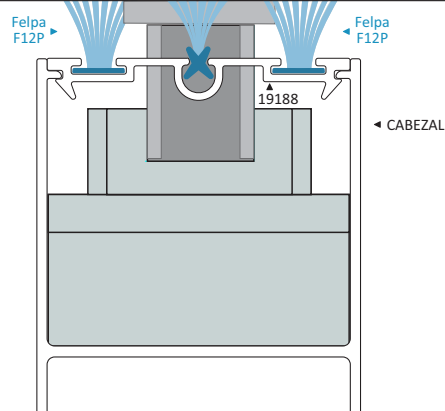
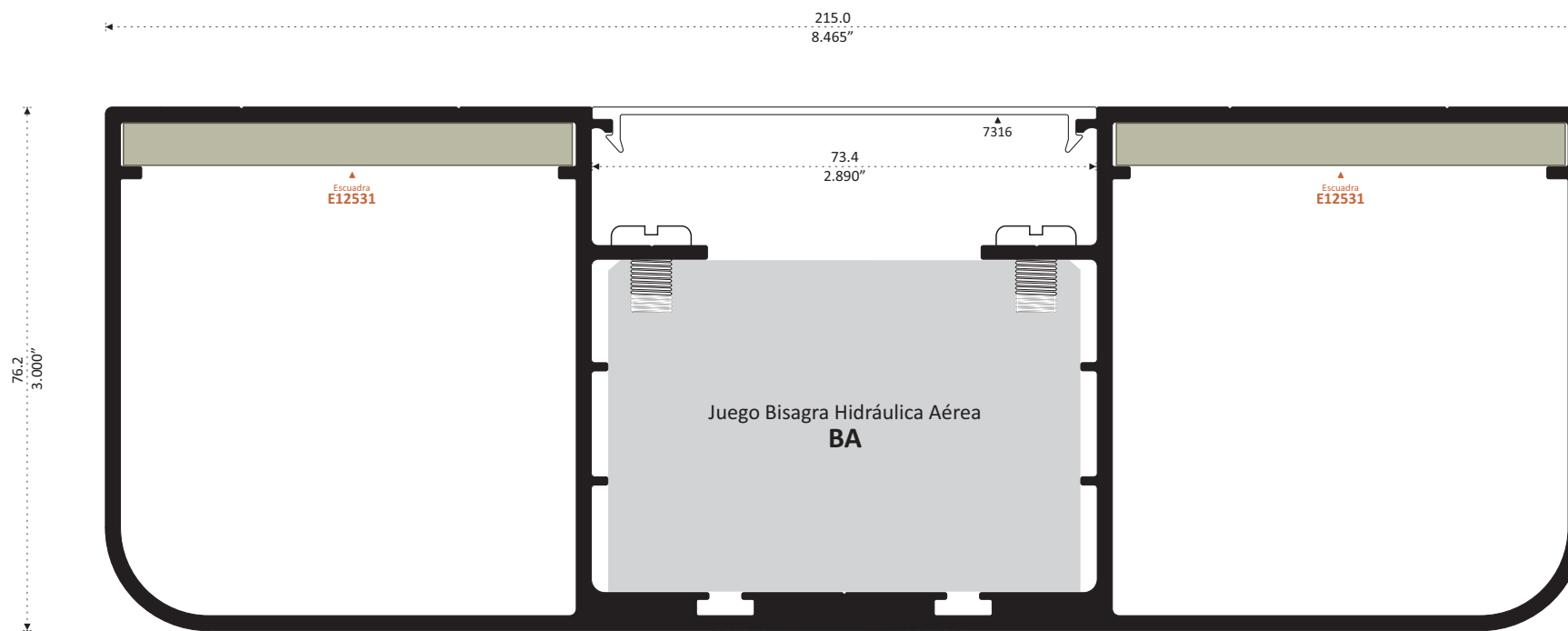

NUEVO

12531
CANAL BISAGRA
Longitud 6.10 m

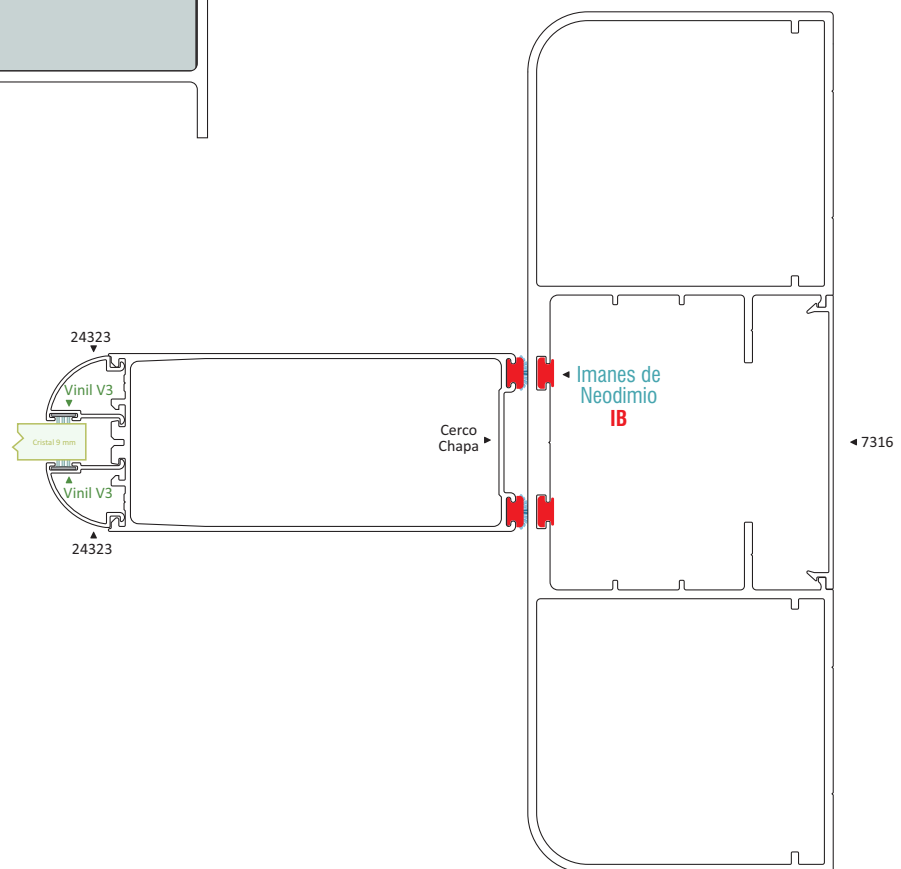
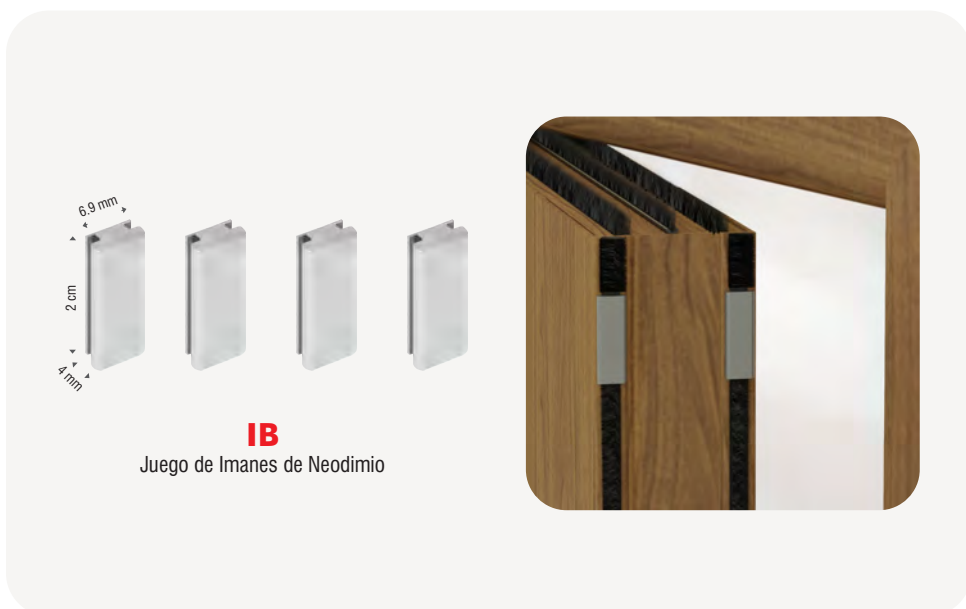



P U E R T A B A T I E N T E T O S C A N A

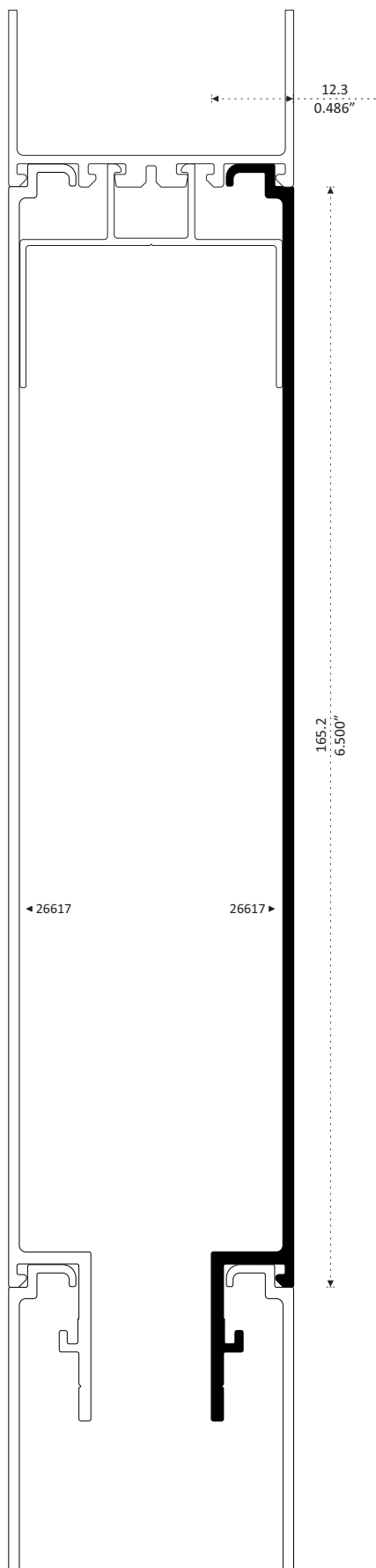

26617
DUELA LISA
Longitud: 6.10 m

ENSAMBLE DE DUELAS



VISTA ABIERTA



VISTA CERRADA

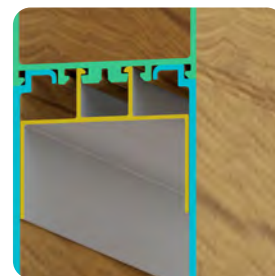
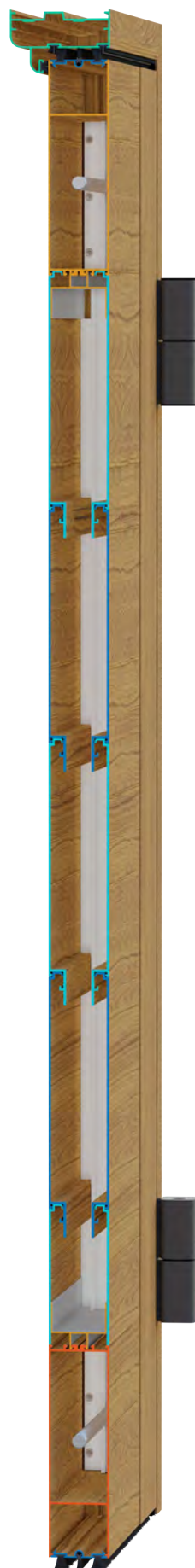

SOPORTE HORIZONTAL

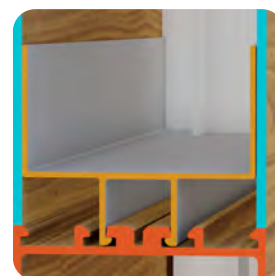

SOPORTE HORIZONTAL

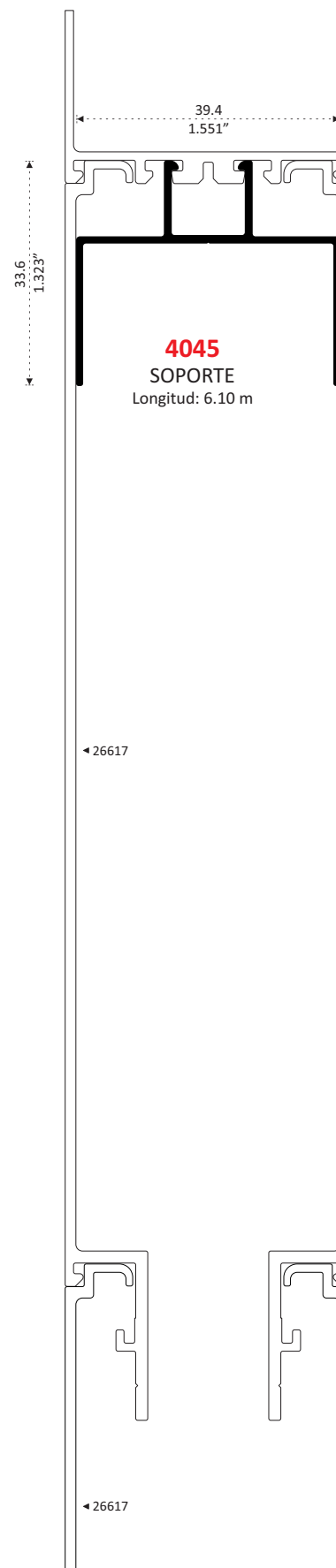

4045
SOPORTE
Longitud: 6.10 m

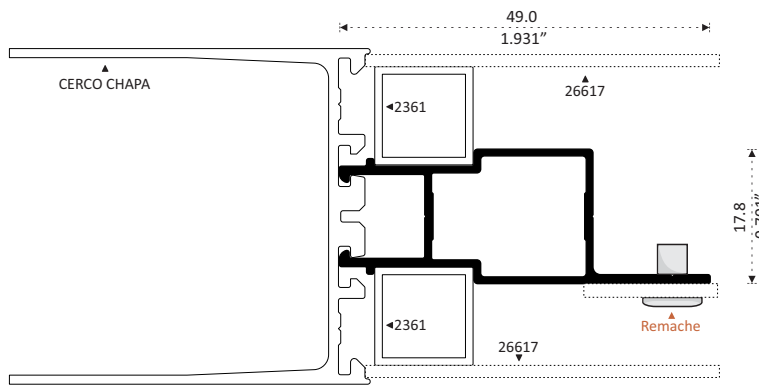

4046
SOPORTE
Longitud: 6.10 m

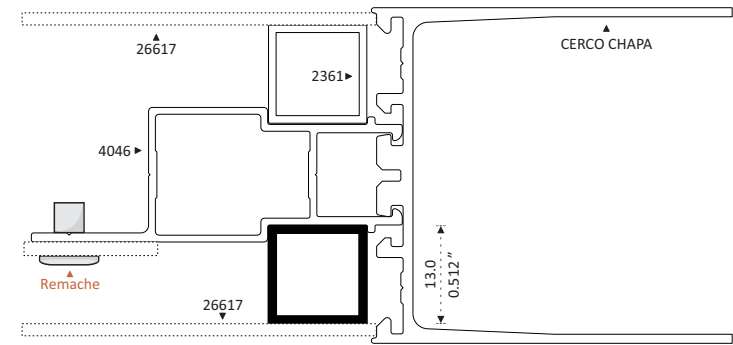

2361
CUADRADO
13 mm
Longitud 6.10 m



POSTE VERTICAL

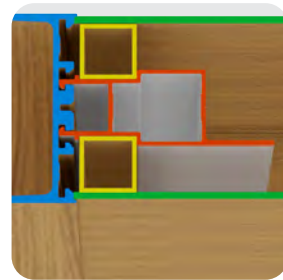

Para un Buen Aislamiento Termo Acústico Colocar Foamular

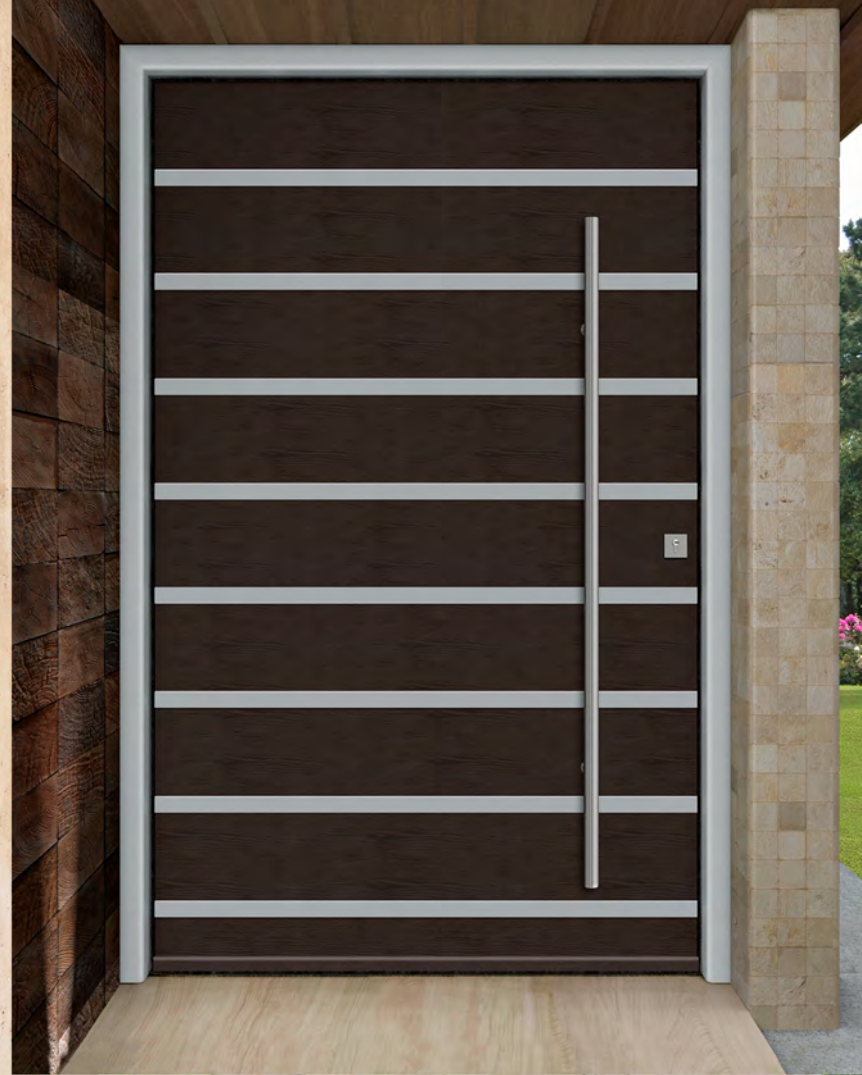



AISLAMIENTO ACÚSTICO

REALIZADO CON 120 DECIBELES AL EXTERIOR

MEDIDA 0.95 X 2.20 m



AISLAMIENTO
37.1 Decibeles

← DUELA 96617



AISLAMIENTO
40.3 Decibeles

← DUELA 96617

CON FOAMULAR Y
 ESPUMA DE POLIURETANO

LÍNEA EXCLUSIVA PERFILETTO

PERMEABILIDAD AL AGUA

DURANTE 20 MINUTOS

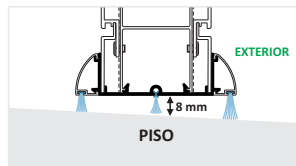

Desnivel de Piso
 3° Grados

Sin
 Filtraciones

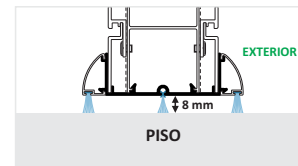

Desnivel de Piso
 0° Grados

Con
 Filtraciones

PERMEABILIDAD AL VIENTO

Medida 1.00 x 1.00 m

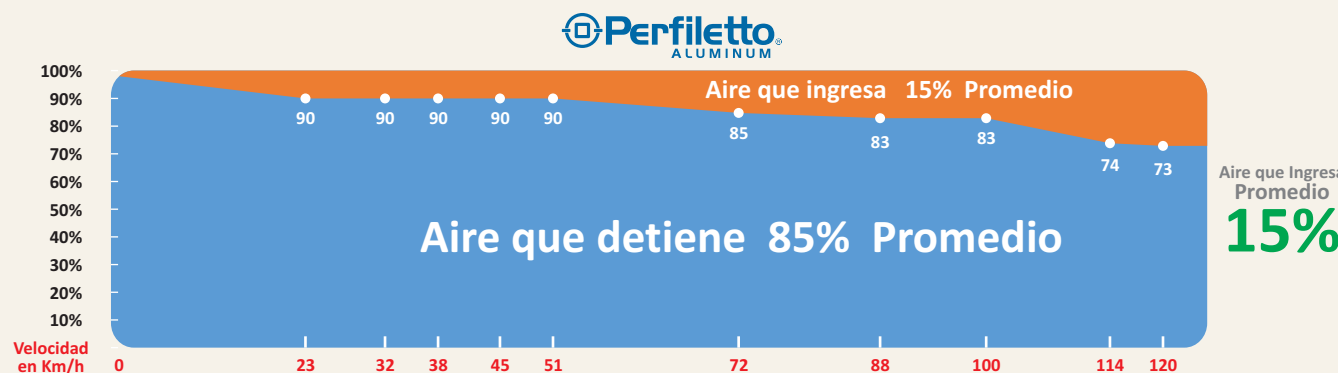

LÍNEA EXCLUSIVA PERFILETTO

RESISTENCIAS A VIENTOS
 PUERTA

Prueba Realizada
 30 Repeticiones de 1 Minuto c/u
 A 120 Km/h

Medida 0.95 X 2.20 m
 Cristal 6 mm
 Duela 96617

LOS PERFILES SIN DEFORMACIÓN
 CONSERVAN SU
 FUNCIONAMIENTO

DUELAS COLOCADAS EN HORIZONTAL

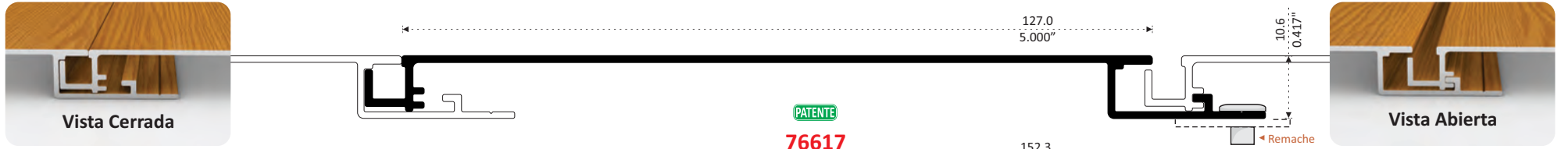

76617 PATENTE
DUELA LISA
Longitud: 6.10 m



96617 PATENTE
DUELA LISA
Longitud: 6.10 m

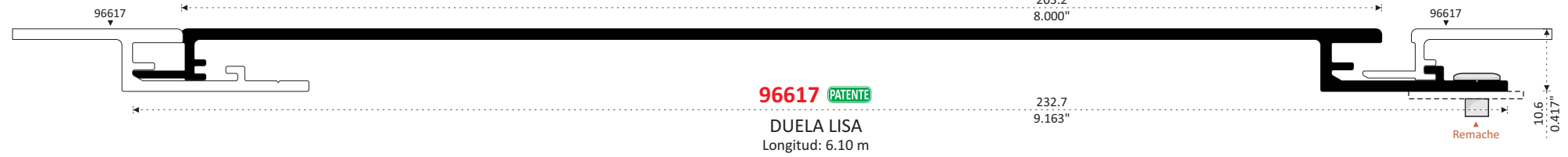

Abertura de 5 mm en Ambos Extremos



86617
DUELA LISA 8"
Longitud: 6.10 m

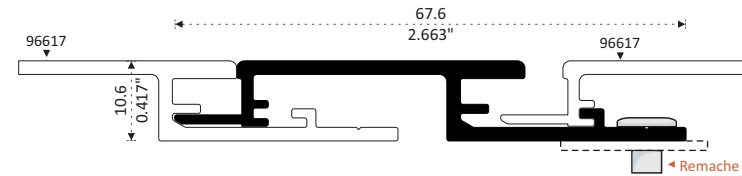

8519
DUELA
Longitud: 6.10 m



BATIENTE 29243
DUELA 96617

CANAL 14386
DUELA 76617

CANAL 8243
DUELA 96617 Y 8519

CANAL 12530
DUELA 86617

CANAL 12531
DUELA 96617 Y 8519

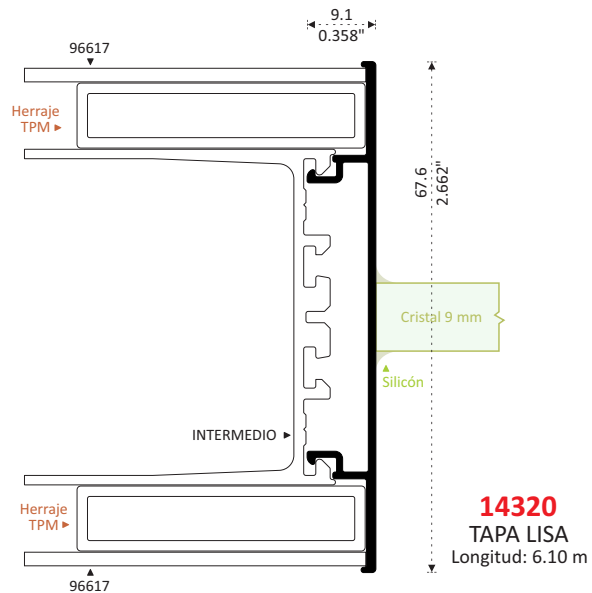

14320
TAPA LISA
Longitud: 6.10 m



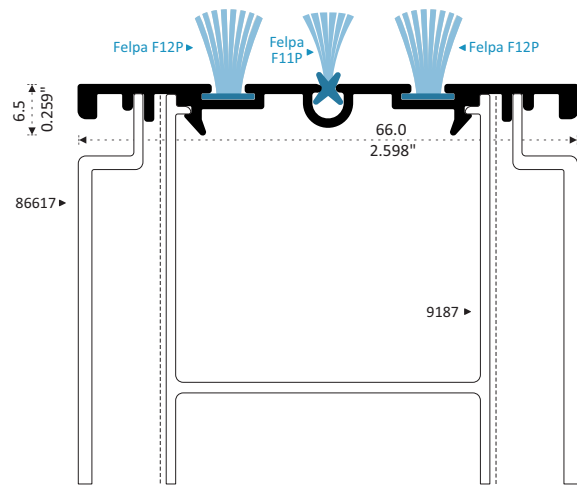

39188 PATENTE
SELLO DE
HERMETICIDAD
SUPERIOR
Longitud 3.05 m

DETALLE SUPERIOR

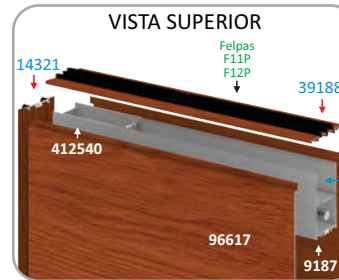
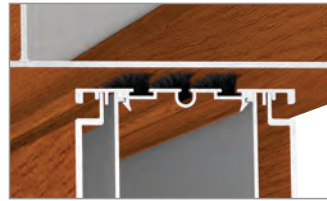

VISTA SUPERIOR

Perfiles Internos
en Natural Mate
ó Cualquier Acabado

29243
BATIENTE
Longitud 6.10 m

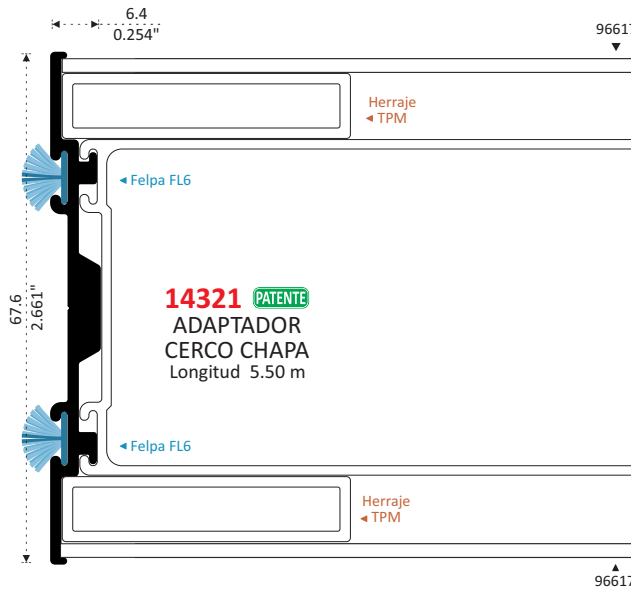
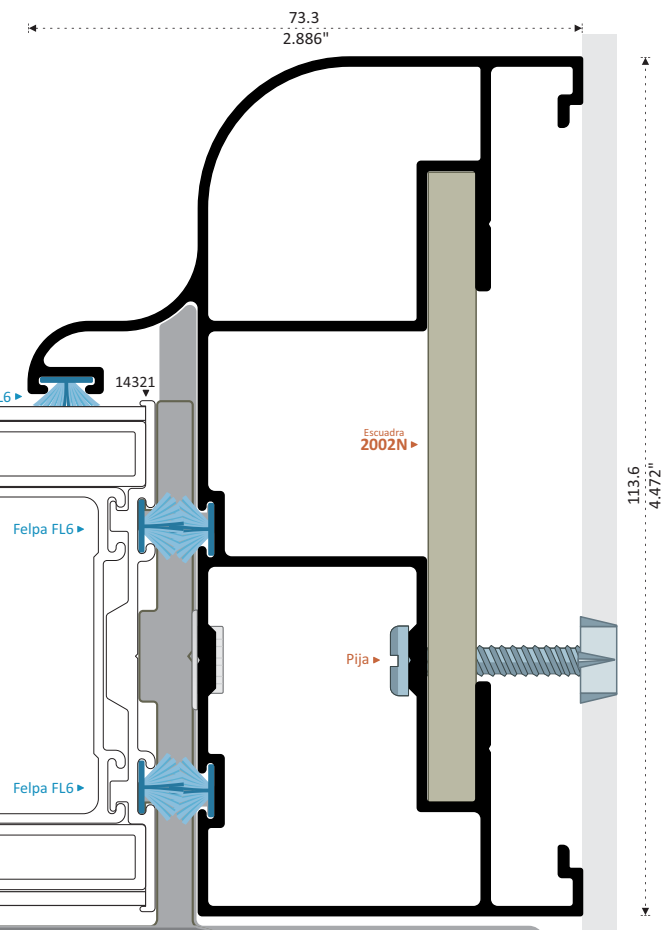

14321 PATENTE
ADAPTADOR
CERCO CHAPA
Longitud 5.50 m

VISTA INFERIOR



Perfiles Internos
en Natural Mate
ó Cualquier Acabado

Tapa Guardapolvo
Clave: TGP
5567

Bisagra BM

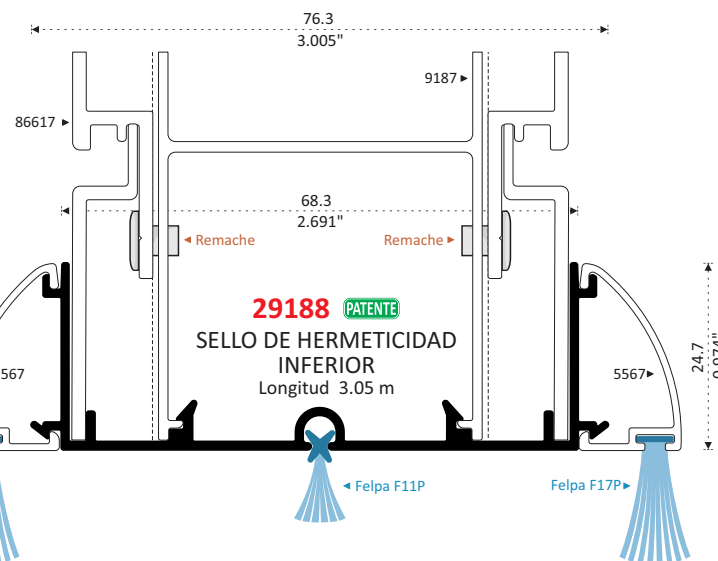

29188 PATENTE
SELLO DE HERMETICIDAD
INFERIOR
Longitud 3.05 m

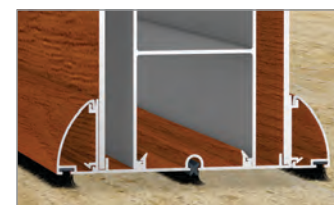

DETALLE INFERIOR

5567 PATENTE
TAPA GUARDAPOLVO
Longitud 6.10 m



Bisagra BM

Puerta Batiente Ferrara



Convierte un Producto Periletto En Algo Extraordinario



Hermeticidad y Aislamiento entre Batiente y Cabezal por sus 3 Felpas



Armado Rápido de Batientes 9109 y 9110 con Escuadra de Botón ET

AJUSTA Y CIERRA EL CORTE

Hermeticidad y Aislamiento Por su Sello de Hermeticidad de 3 Felpas

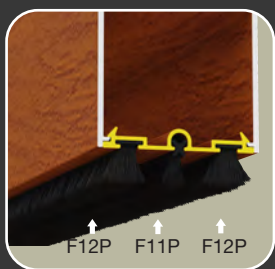

Bisagras



Bisagra BF



Bisagra 1525P



Vinil VHE en Batiente para un Cierre más Hermético



Las Barras de Armado

Trabajan a la Tensión y Compresión

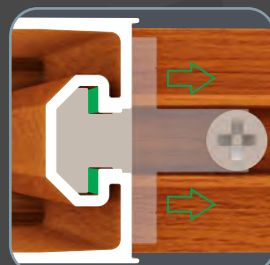
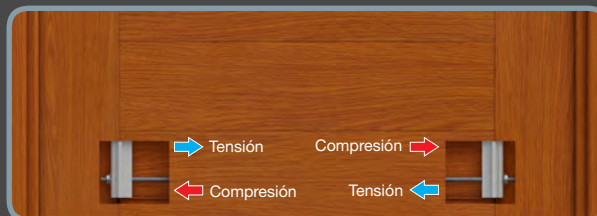

Paredes de Esfuerzo a la Tensión

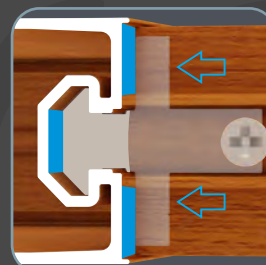

Paredes de Esfuerzo a la Compresión

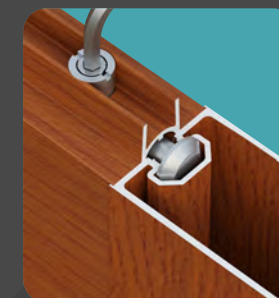
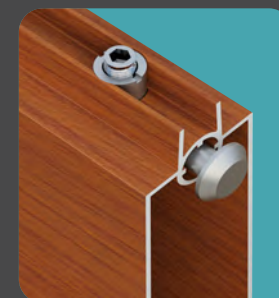

Rápido Ensamble de Intermedio y Cerco Chapa Mediante Adaptadores



Fijación de Barra con Opresores de Punta en Acero Inoxidable

Opresores para Mayor Rapidez en el Armado

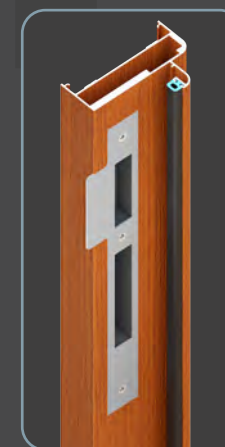

Colocación de Chapa en Batiente y Cerco Chapa

Aislamiento Acústico

Duela-Duela 37.4 Decibles
Cristal-Duela 38.3 Decibles
Cristal-Cristal 41.3 Decibles

Permeabilidad a Viento y Polvo

Con 9204
Con 412542

Aire que Detiene 83 %
Aire que Detiene 85 %

Resistencia A Vientos Sin Deformar el Perfil

Puerta 120 Km/h



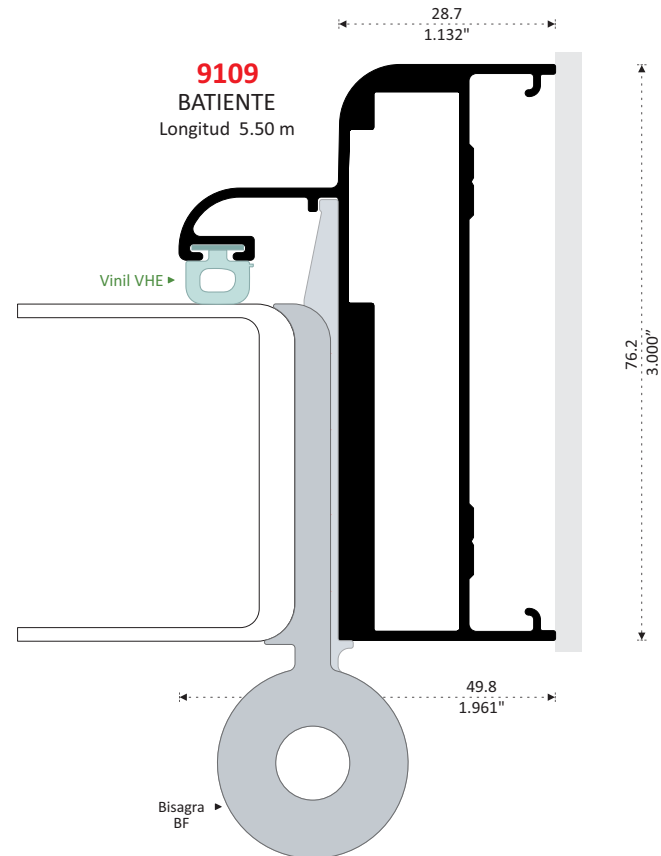
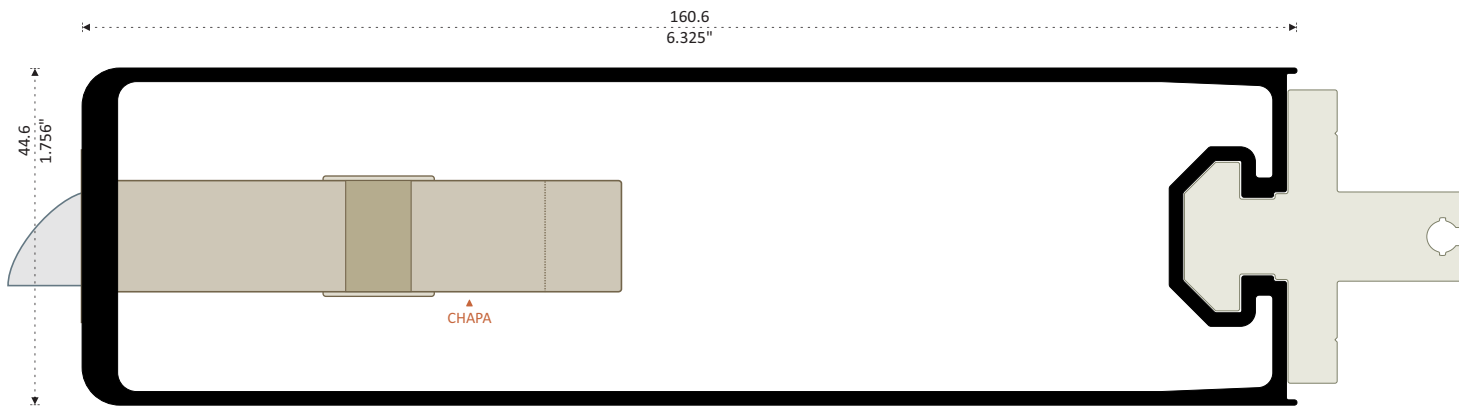
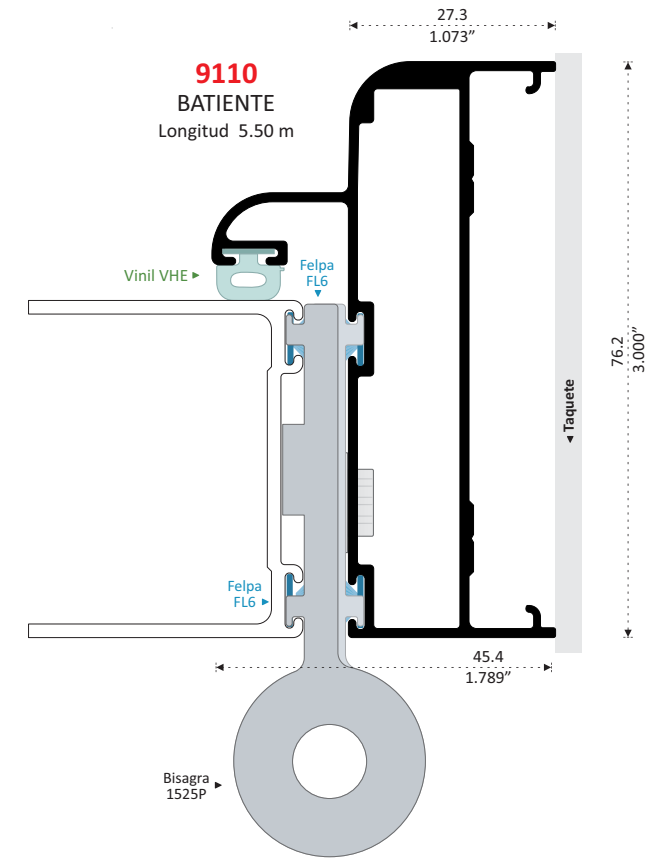
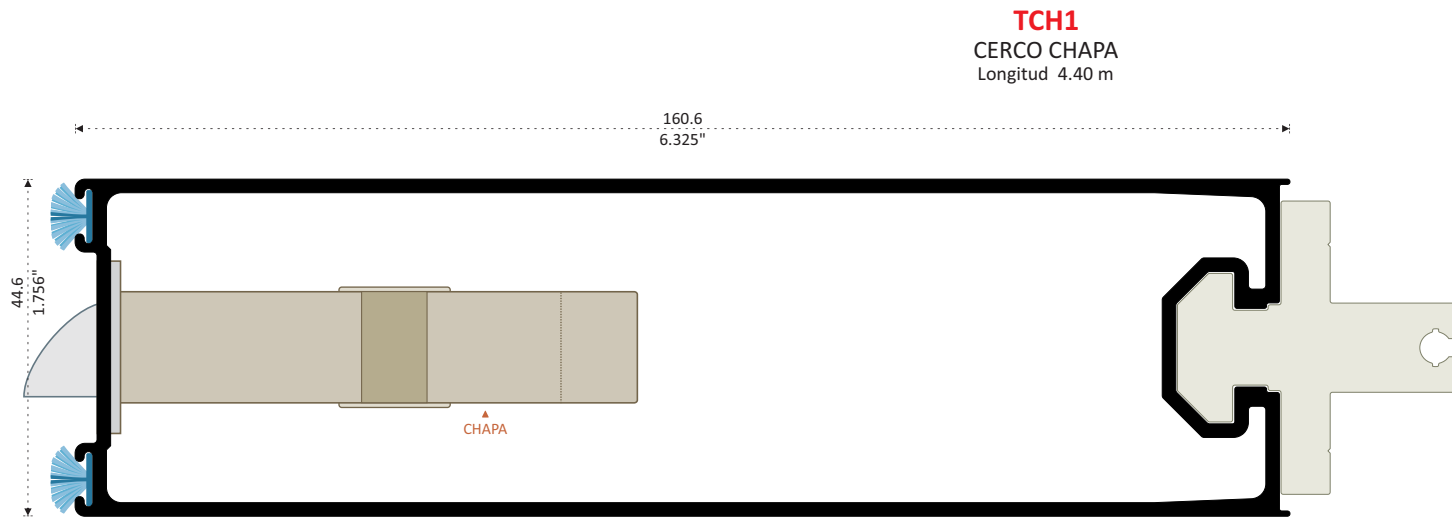

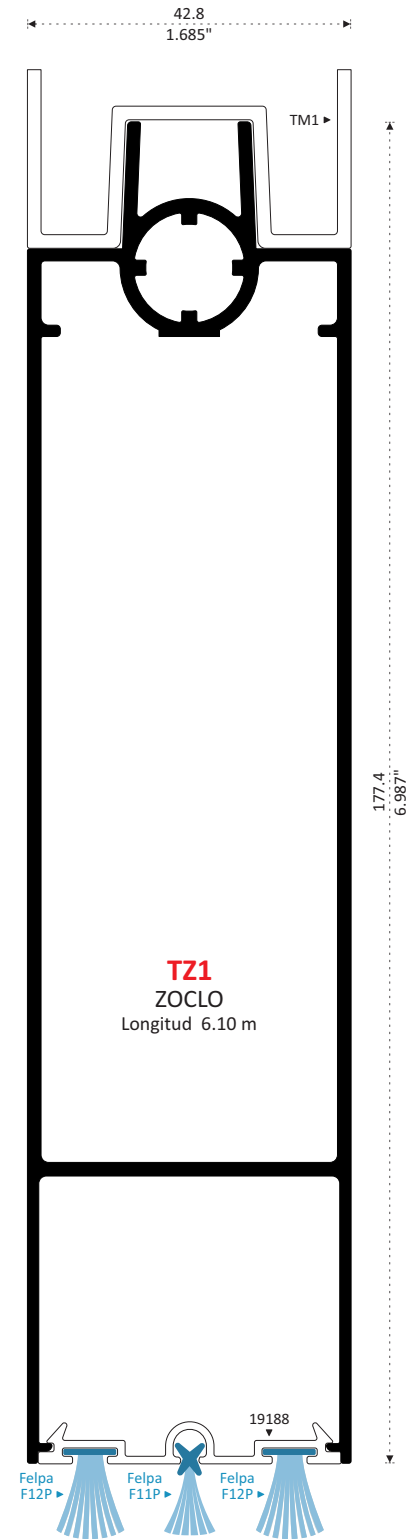
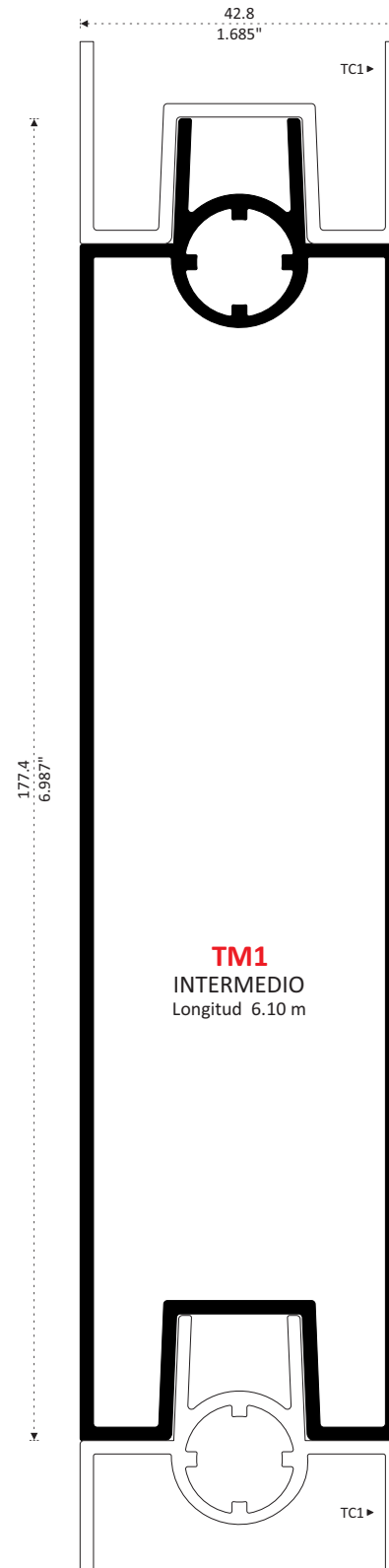
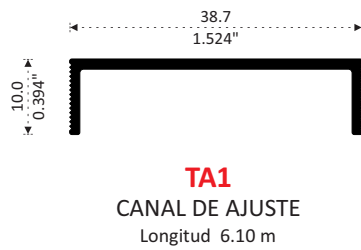
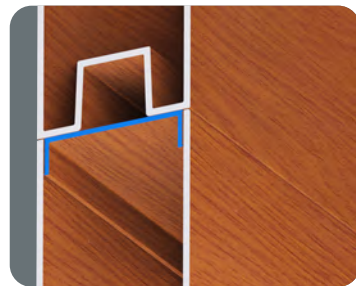
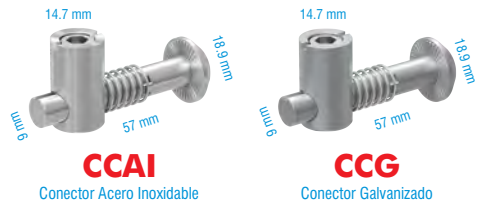
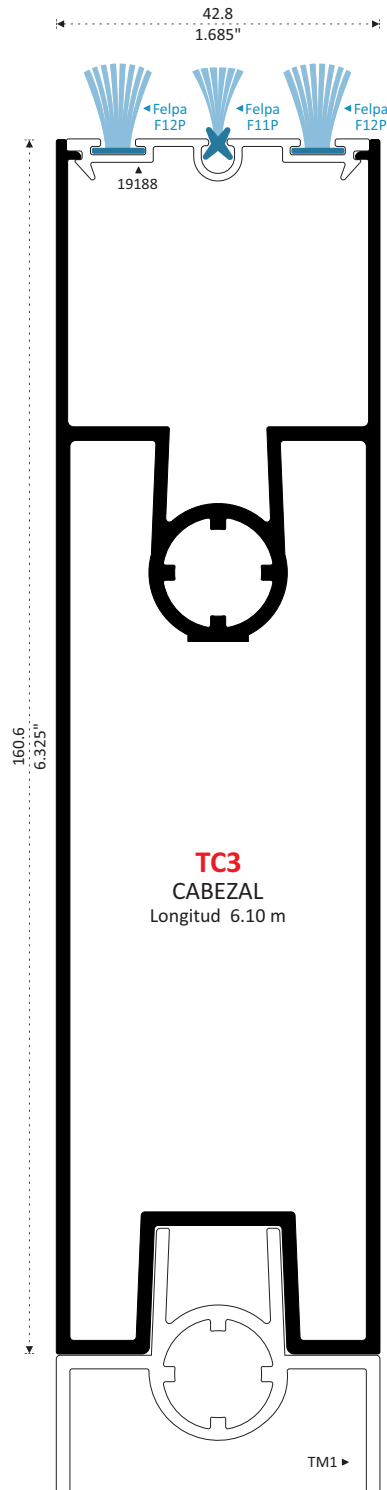

SERIE 35 BATIENTE Ó PROYECCIÓN

Proyección

Manija Batiente - Proyección



MR35

Diseñada para Perfiles Rectos

Manija Batiente - Proyección



M35

Diseñada para Perfiles Curvos



Guías Para Instalación de:



Brazos de Proyección

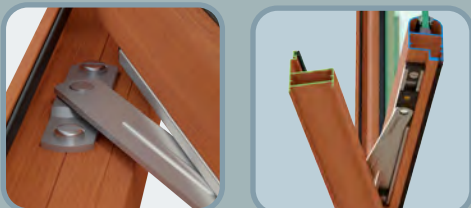

Brazos Fricción



Bisagras

Vista Frontal Sencilla y Elegante sin Vinil en el Marco

Abatible



Armado Rápido de Marco con Escuadra de Botón EM35



Armado Rápido de Contramarco con Escuadra de Botón EC35



Ventajas Vinilos Base Rigida

- Colocación Rápida
- No se Contrae después de su Colocación
- Alta Resistencia a la Intemperie

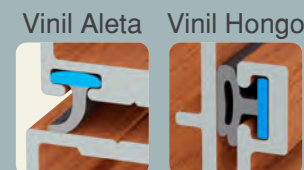

Aumentan la Hermeticidad:

- Acústica
- Viento
- Polvo
- Agua

DESCUBRE OTRAS OPCIONES PARA TU CANCELERÍA

ELIGE EL ESTILO DE MOSQUITERO

Batiente Multi-Líneas



Cierre con Imanes

Fijo

Apertura y Cierre Con Operador de Brazo



Intermedio Hojas Dobles

Marco Colonial

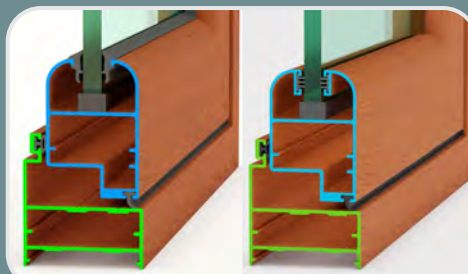

Vinil Cuña

Vinil Interior

ELIGE EL ESTILO DE MARCO

Marco Recto

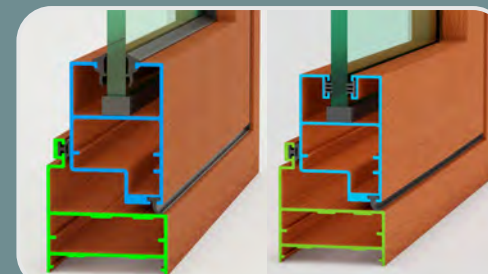

Vinil Cuña

Vinil Interior

Cristal Doble

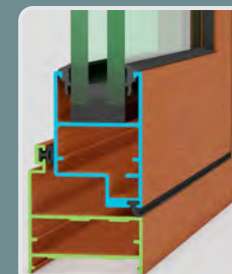

Separador de 1/4"

■ Aislamiento Acústico
Cristal Sencillo 42.3 Decibles
Cristal Doble 42.3 Decibles

■ Permeabilidad a Viento y Polvo
Aire que Detiene 96 %

■ Resistencia A Vientos Sin Deformar el Perfil 100 Km/h

AI SLAMI ENTO ACÚSTICO
 REALIZADO CON 120 DECIBELES AL EXTERIOR
 MEDIDA 1.00 x 1.00 m



Perfiletto ALUMINUM
11% Más Eficiente



OTROS COMPETIDORES

CRISTAL DOBLE

6mm + SEPARADOR 2091 + 6mm



Perfiletto ALUMINUM
5% Más Eficiente



OTROS COMPETIDORES

PERMEABILIDAD AL AGUA DURANTE 20 MINUTOS
 VENTANA MEDIDA 1.00 x 1.00 m

VELOCIDAD KM/H	Agua	Aire
20	50%	50%
40	50%	50%
60	50%	50%
80	50%	50%
100	50%	50%
120	60%	40%

SIN MOSQUITERO
Sin Filtraciones

MOSQUITERO FIJO 15173
Sin Filtraciones

PERMEABILIDAD AL VIENTO Medida 1.00 x 1.00 m

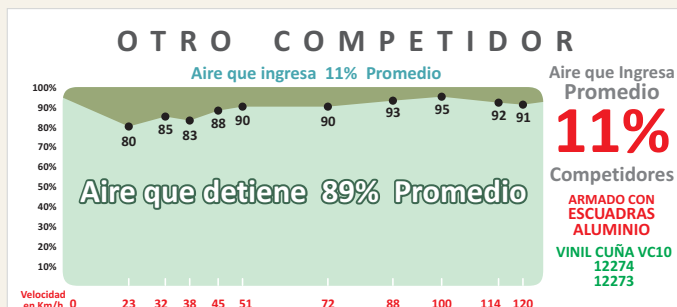
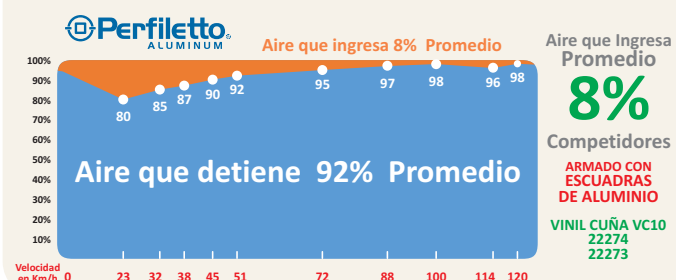
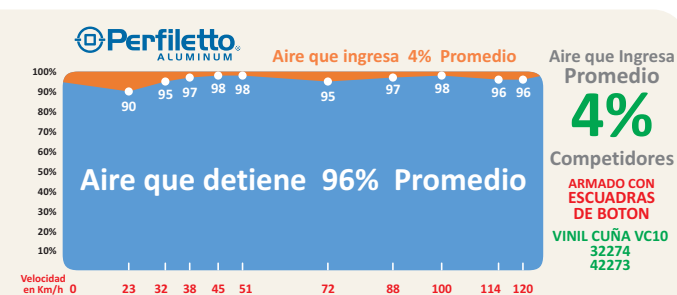
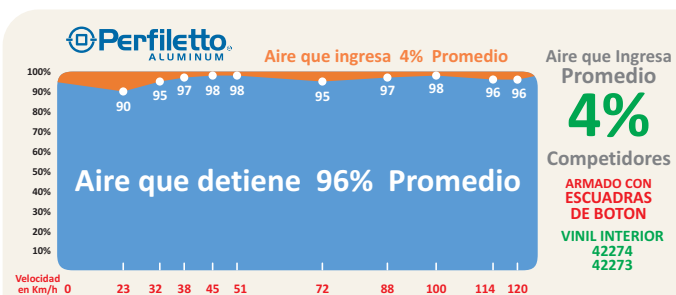

RESISTENCIAS A VIENTOS

VENTANA
 Prueba Realizada
30 Repeticiones de 1 Minuto c/u
A 100 Km/h
 Medida 1.00 x 1.00 m
 Cristal 6 mm
LOS PERFILES SIN DEFORMACIÓN CONSERVAN SU FUNCIONAMIENTO

PROYECCION

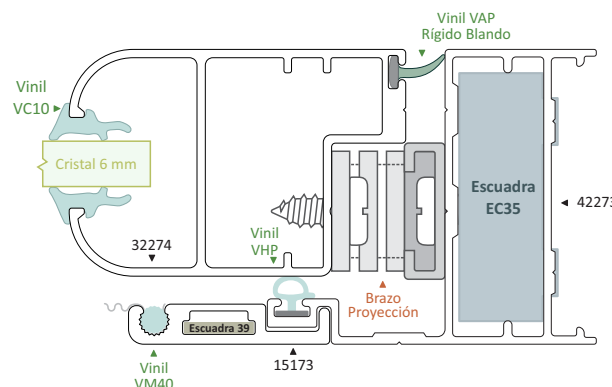
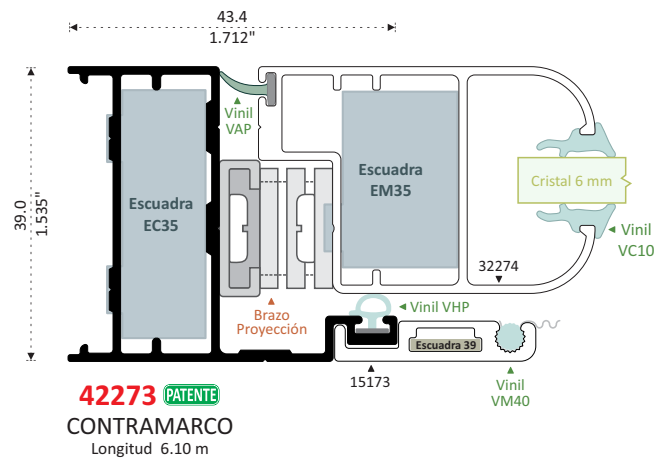

Armado de Marco con Escuadra EM35



AJUSTA Y CIERRA EL CORTE

Elegante por su Vinil en Contramarco

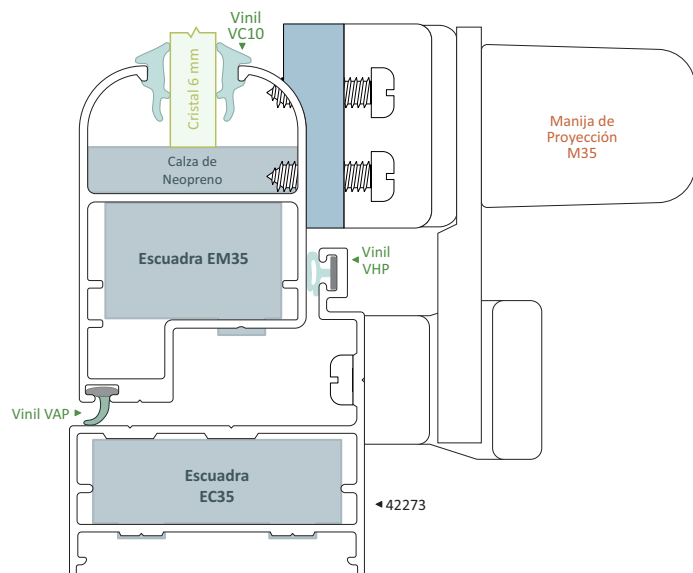
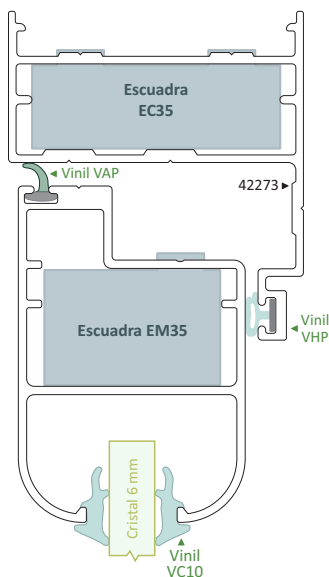

VINIL ALETA VAP EN MARCO



VINIL INTERIOR OCULTO EN CONTRAMARCO

BATIENTE

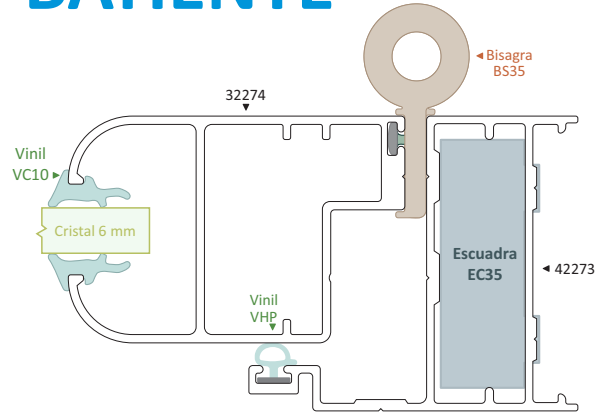
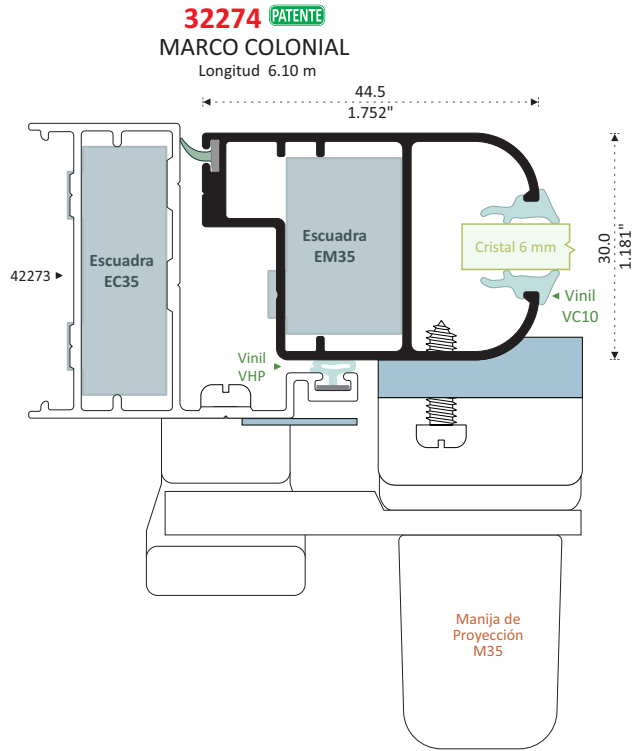

AJUSTA Y CIERRA EL CORTE

Elegante por su Vinil en Contramarco



VINIL INTERIOR OCULTO EN CONTRAMARCO



VINIL ALETA VAP EN MARCO

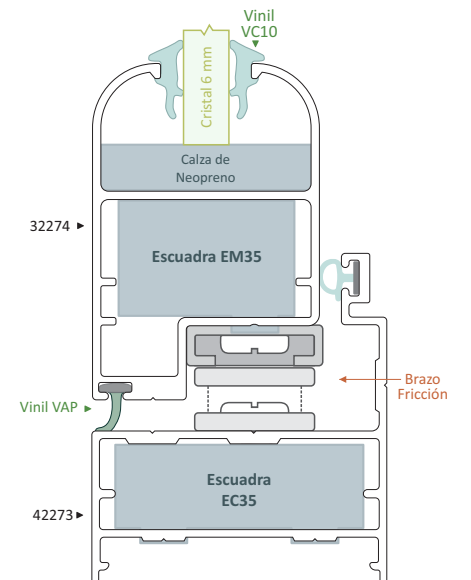
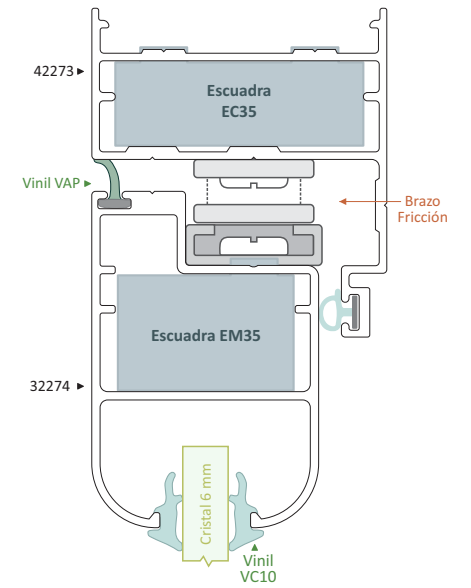

Vista Elegante por su Vinil en Contramarco

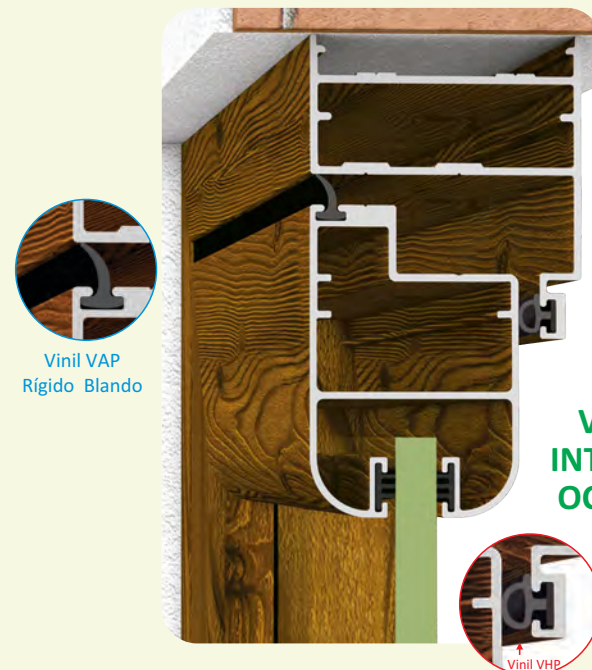
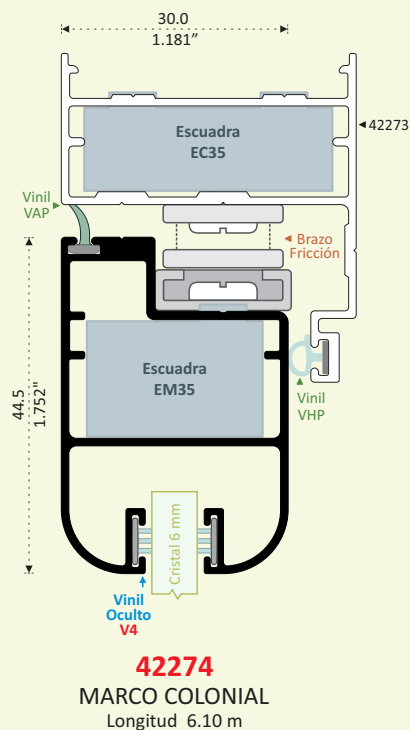

CRISTAL DOBLE

32276
MARCO
Longitud 6.10 m

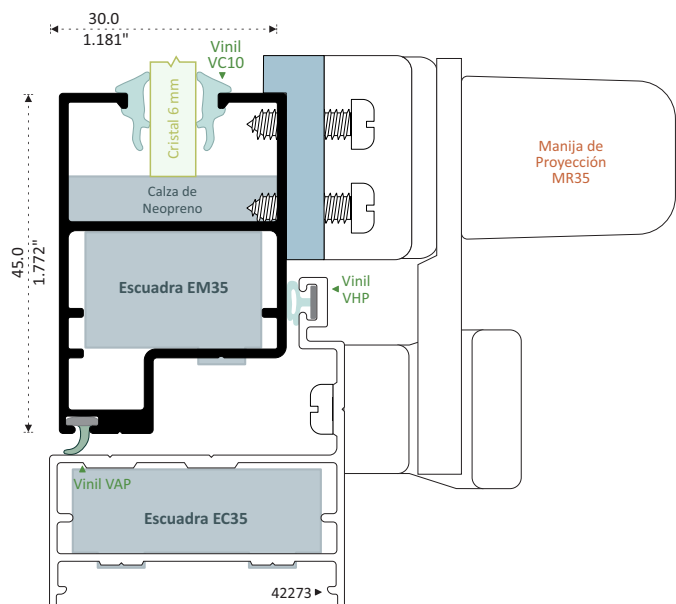

22277 PATENTE
MARCO
CRISTAL DOBLE
Longitud 6.10 m

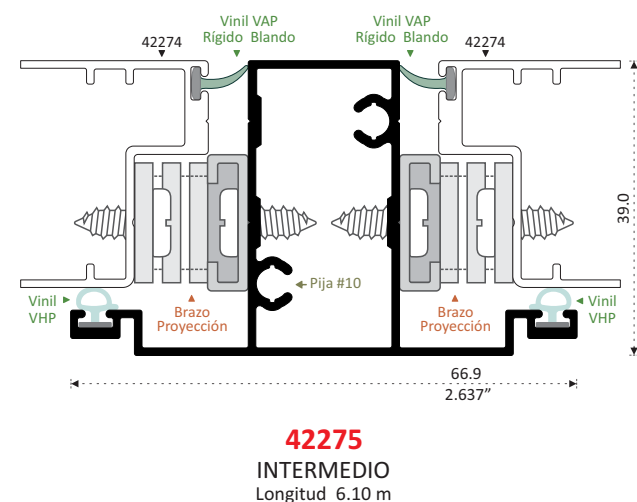
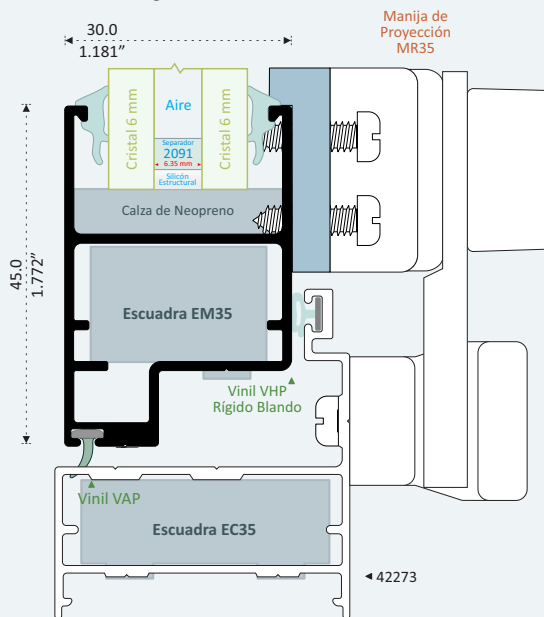

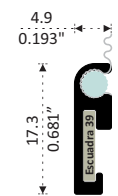
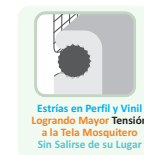
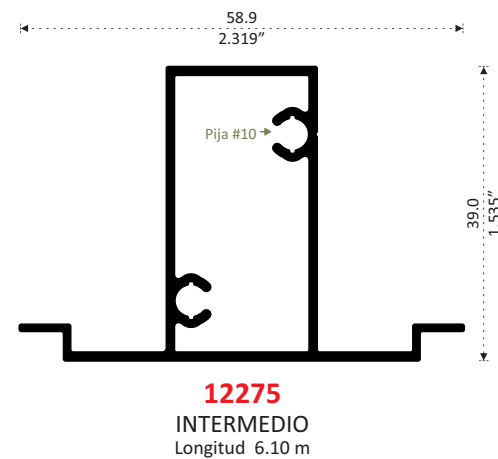
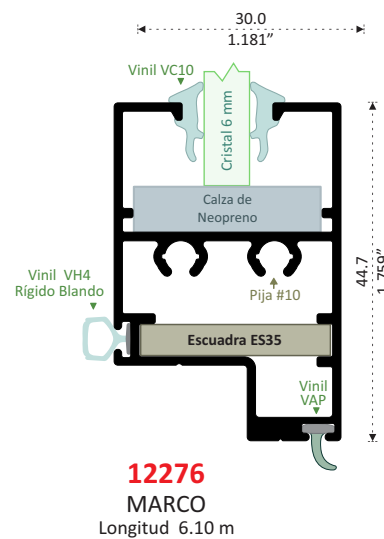
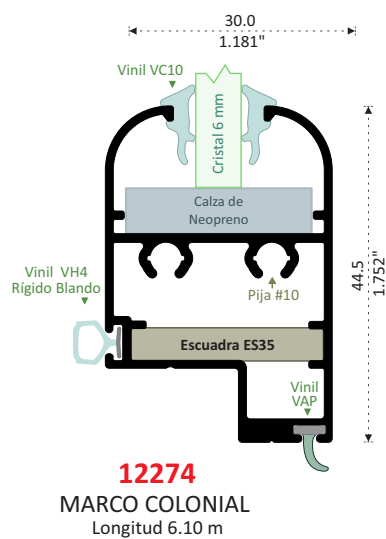
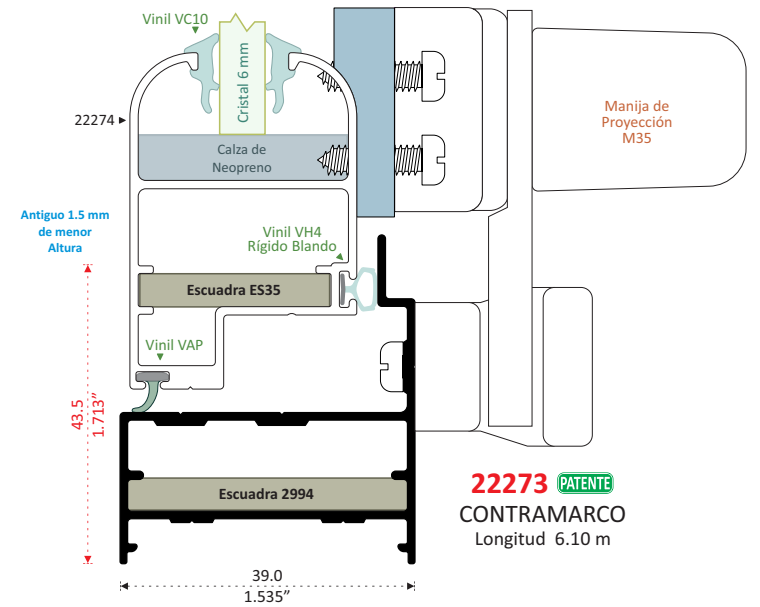
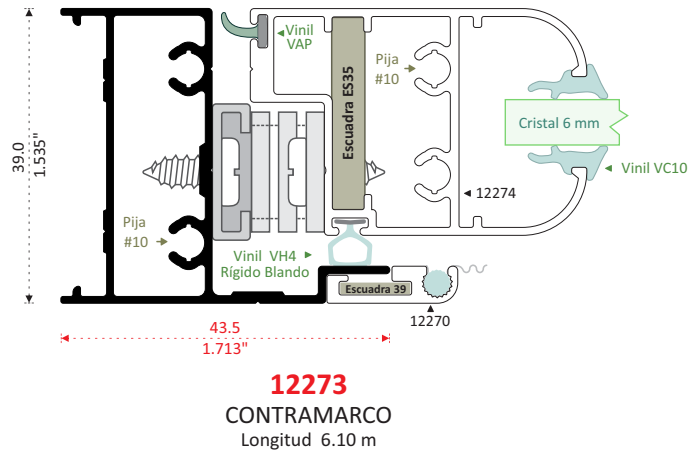
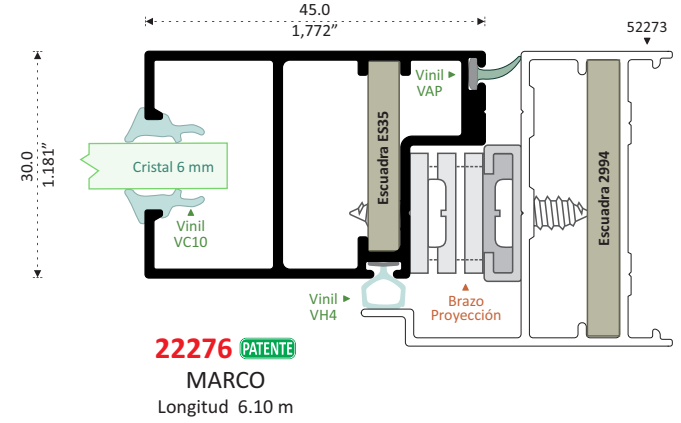
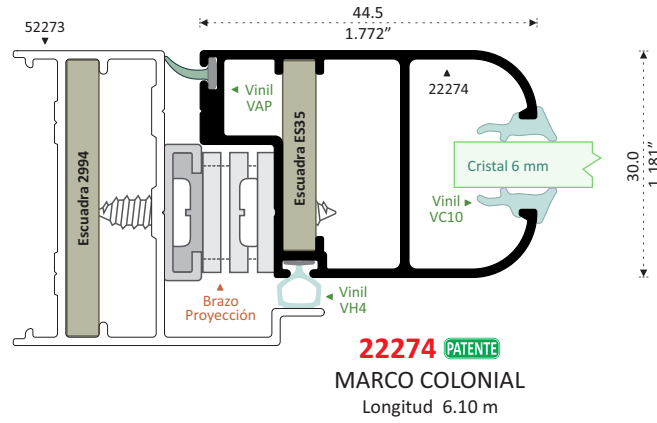

12270
MOSQUETERO FIJO
Longitud 6.10 m

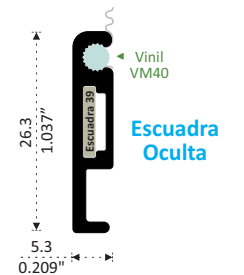

15173
MOSQUETERO FIJO
Longitud 6.10 m

Escuadra Oculta

22271 PATENTE
CONTRAMARCO MOSQUITERO
Longitud 6.10 m

22270 PATENTE
MOSQUITERO
Longitud 6.10 m

Interior View: Escuadra EC35, Escuadra EM35, Escuadra EMR, Escuadra ES22, Bisagra Clave: BS35, Vinil VC10, Vinil VHP Rígido Blando, Vinil VM45, Felpa FL6, Imanes Clave: ICC, Tapón TPC.

Exterior View: Escuadra ES22, Vinil VM45, Felpa FL6, Imanes Clave: ICC, Tapón TPC.

Mosquetero Batiente Multilíneas

Colocar Imán en el Lado del Cierre

Imán

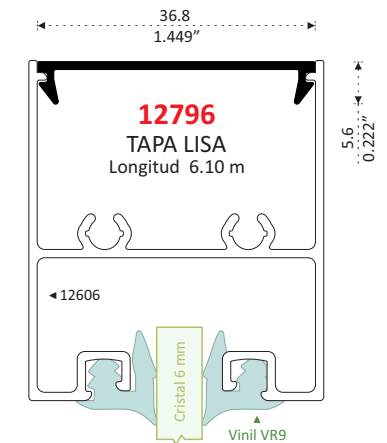
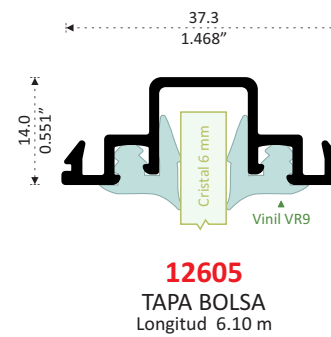
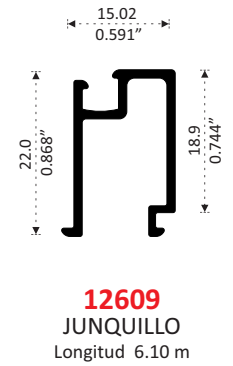
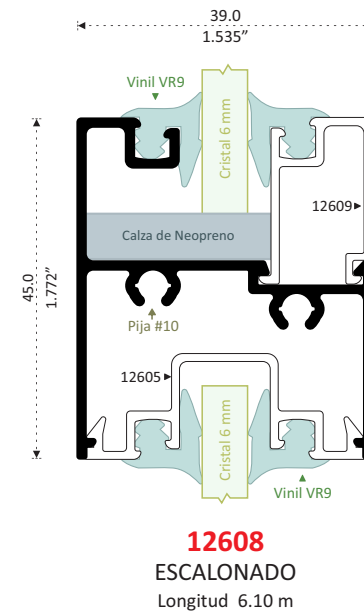
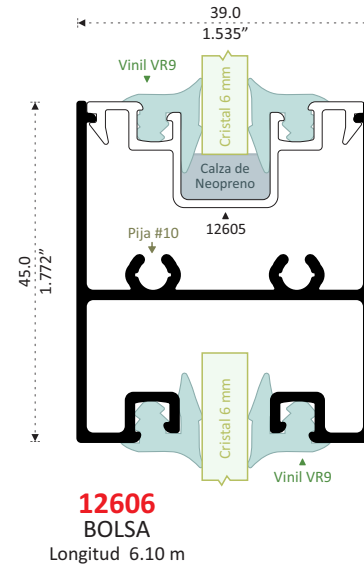

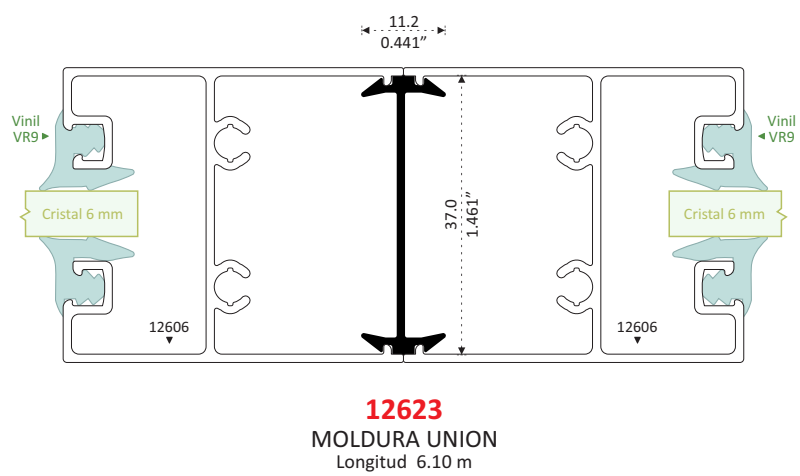
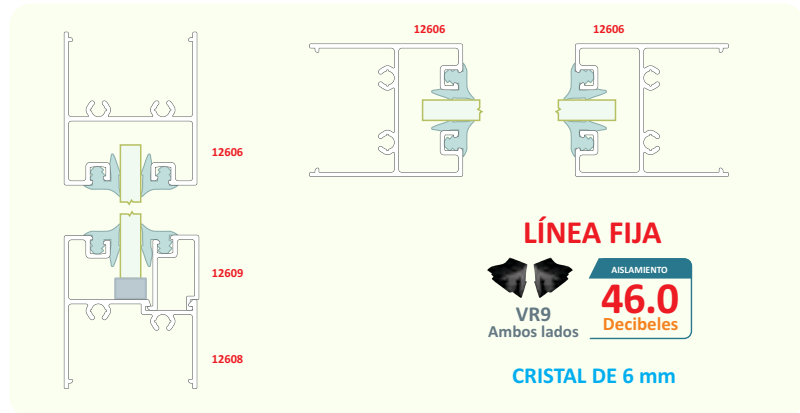
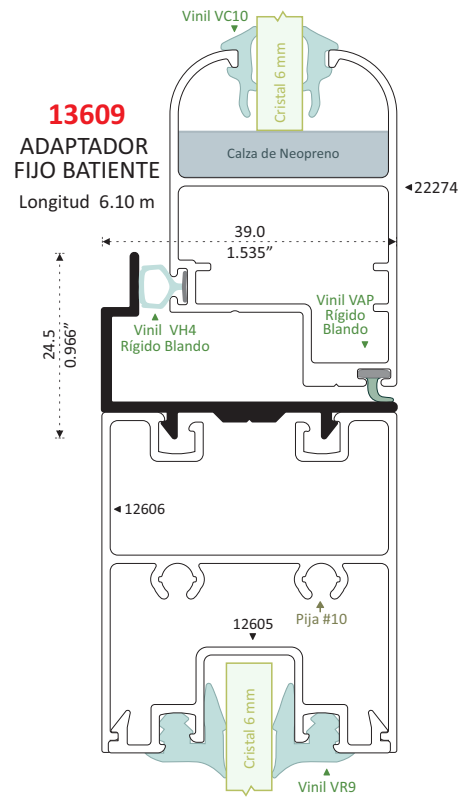
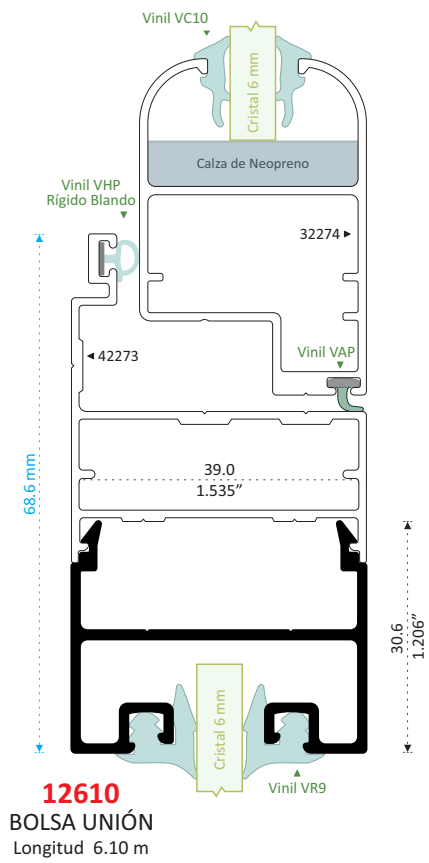

CRISTAL DOBLE

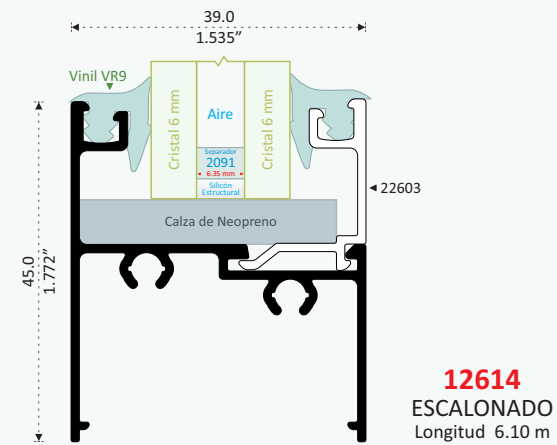
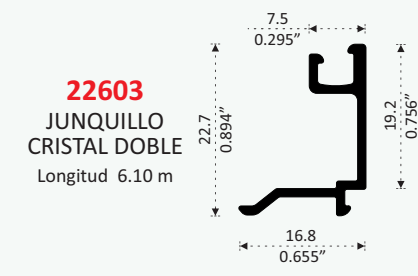
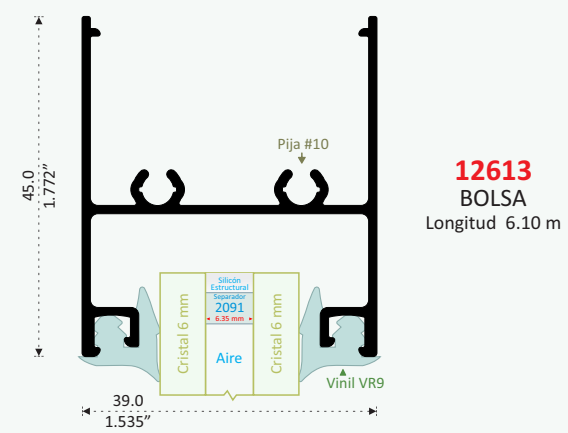
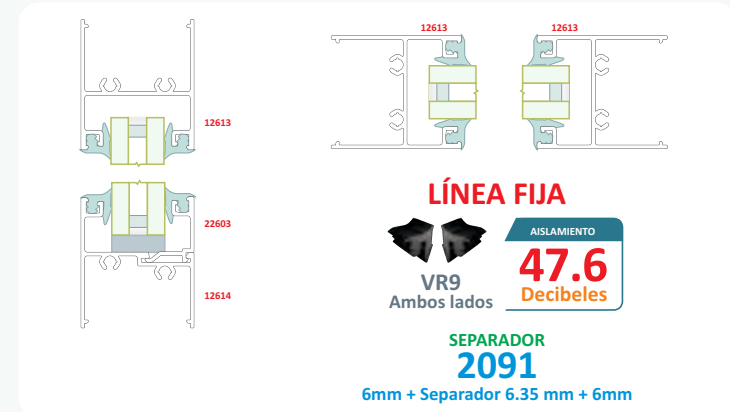

SERIE 50 BATIENTE Ó PROYECCIÓN

Proyección

Guías Para Instalación de:



- Brazos de Proyección



- Brazos Fricción



- Bisagras

Abatible



Armado Rápido de Marco
con
Escuadra de Botón
EM50



Armado Rápido de Contramarco
con
Escuadra de Botón
EC50

Ventajas
Vinilos Base Rigida

- Colocación Rápida
- No se Contrae después de su Colocación
- Alta Resistencia a la Intemperie

Vinil Aleta Vinil Hongo



Aumentan la Hermeticidad:

- Acústica
- Viento
- Polvo
- Agua

Manija
Batiente - Proyección

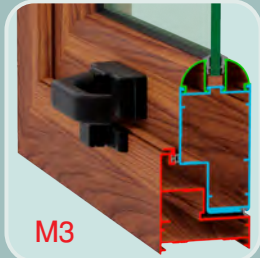

M3



Vista Frontal
Sencilla y Elegante
sin
Vinil en el Marco



DESCUBRE OTRAS OPCIONES PARA TU CANCELERÍA

Batiente
Multi-Líneas

ELIGE EL ESTILO DE MOSQUITERO

Fijo



Cierre con Imanes

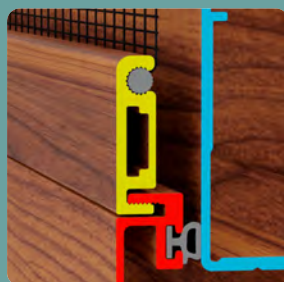

Apertura y Cierre
Con Operador de Brazo

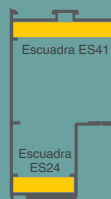

En Hojas Mayores a 20 kg
Armar con Escuadras de Aluminio
y Pijas 2618

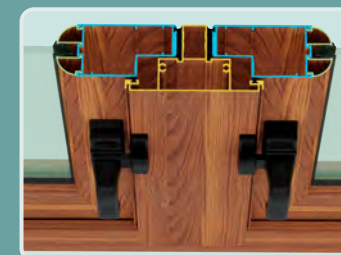

Intermedio
Hojas Dobles

15 Diferentes
Opciones
de
Junquillos

■ Aislamiento Acústico
Cristal Sencillo 45.8 Decibles
Cristal Doble 46.0 Decibles

■ Permeabilidad a Viento y Polvo
Aire que Detiene 96 %

■ Resistencia A Vientos Sin Deformar el Perfil 120 Km/h

AISLAMIENTO ACÚSTICO
 REALIZADO CON 120 DECIBELES AL EXTERIOR
 MEDIDA 1.00 x 1.00 m

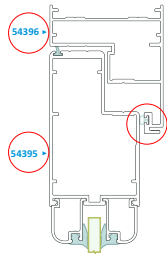

CONTRAMARCO 54396 MARCO 54395

Perfiletto ALUMINUM

AISLAMIENTO
45.8
 Decibeles

Vinil VAP Vinil VHP VR9 Ambos lados

8%
 Más Eficiente

AISLAMIENTO
42.4
 Decibeles

OTROS COMPETIDORES

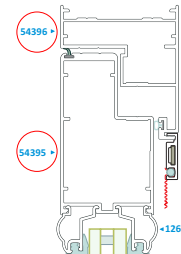

CONTRAMARCO 54396 MARCO 54395

Perfiletto ALUMINUM

AISLAMIENTO
46.0
 Decibeles

Vinil VAP Vinil VHP VR9 Ambos lados

CRISTAL DOBLE
 6mm + SEPARADOR 2091 + 6mm

11%
 Más Eficiente

AISLAMIENTO
41.4
 Decibeles

OTROS COMPETIDORES

PERMEABILIDAD AL AGUA DURANTE 20 MINUTOS
 VENTANA MEDIDA 1.00 x 1.00 m

VELOCIDAD KM/H	Agua	Aire
20	50%	50%
40	50%	50%
60	50%	50%
80	50%	50%
100	50%	50%
120	60%	40%

SIN MOSQUITERO
 Sin
 Filtraciones

MOSQUITERO FIJO
 25173
 Sin
 Filtraciones

PERMEABILIDAD AL VIENTO Medida 1.00 x 1.00 m

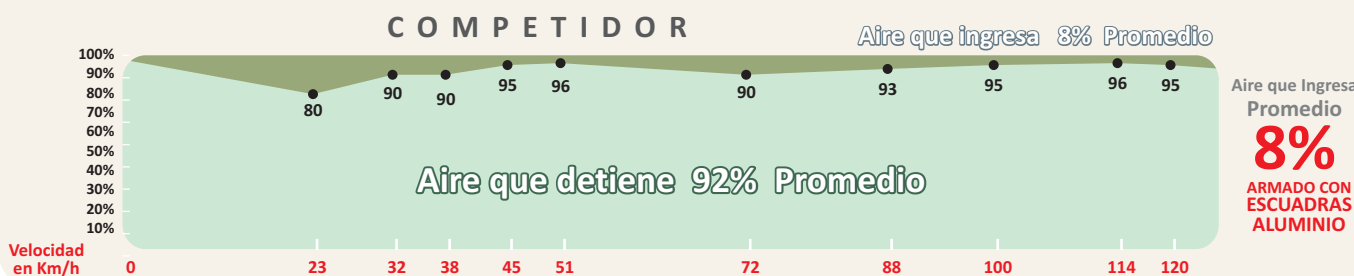
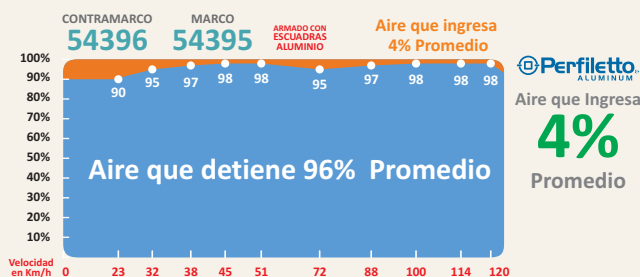
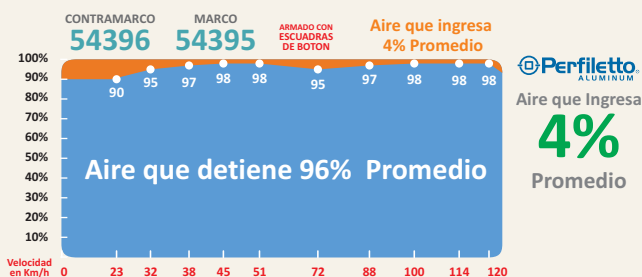

RESISTENCIAS A VIENTOS

VENTANA

Prueba Realizada
 30 Repeticiones de 1 Minuto c/u
 A 120 Km/h

Medida 1.00 x 1.00 m
 Cristal 6 mm

LOS PERFILES SIN DEFORMACIÓN
 CONSERVAN SU
 FUNCIONAMIENTO

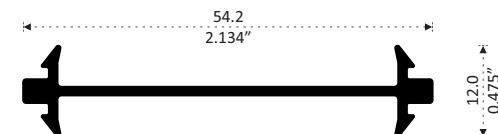
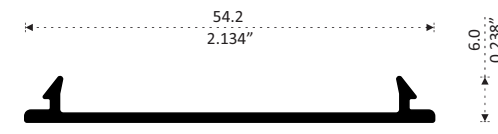
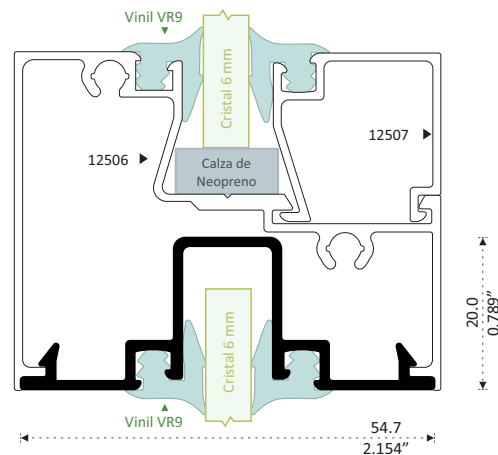
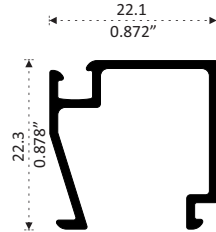
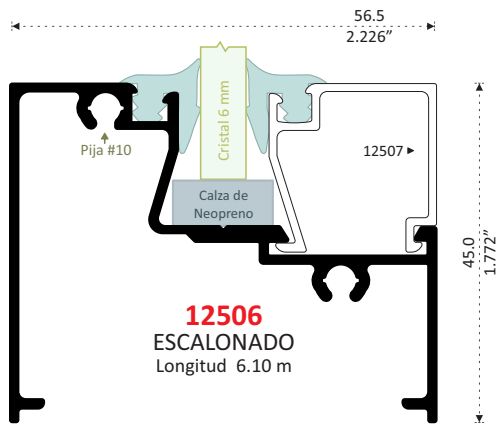
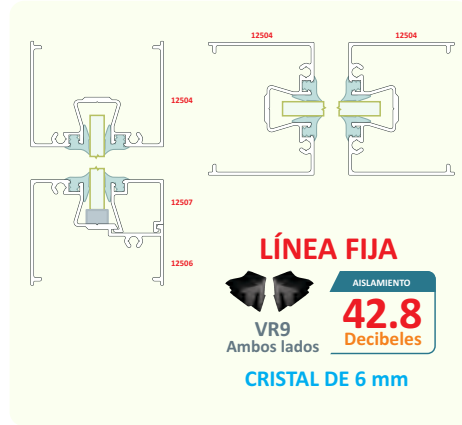
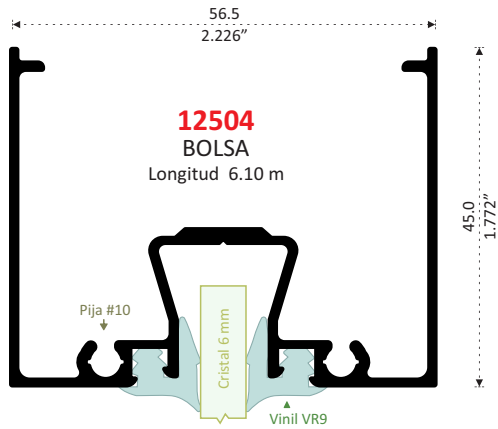

CRISTAL DOBLE

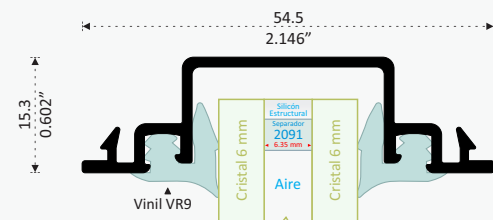
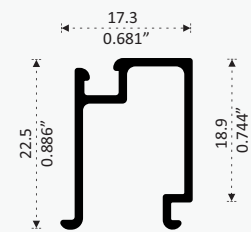
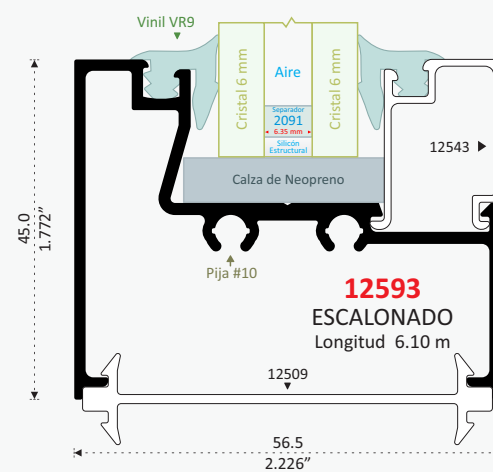
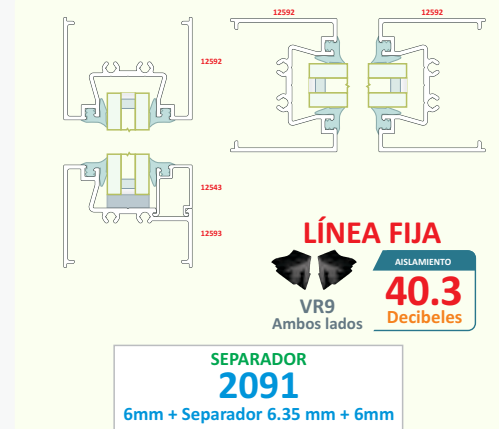
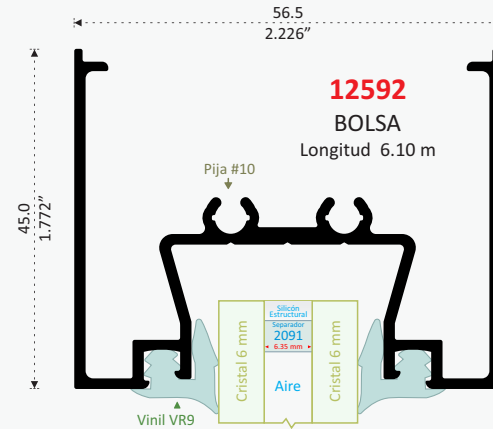

BATIENTES

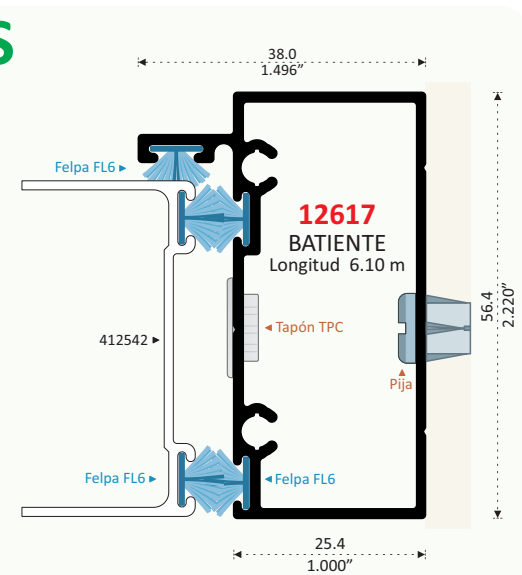
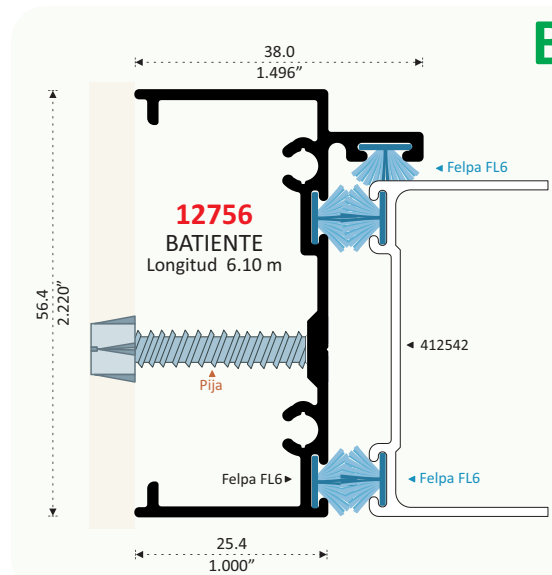

Elegante por su Vinil en Contramarco

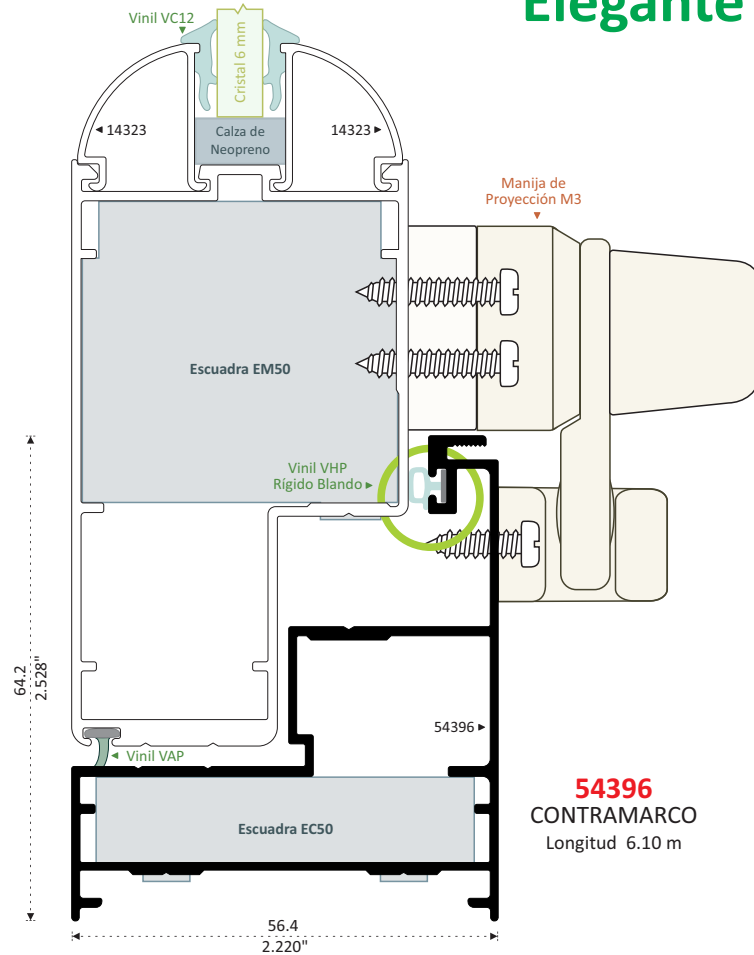

54396
CONTRAMARCO
Longitud 6.10 m



Armar El Marco
de la Hoja con
Escuadra de Botón
Hasta 20 Kg.

Más de 20 Kg.
Armar con
Escuadra de
Aluminio

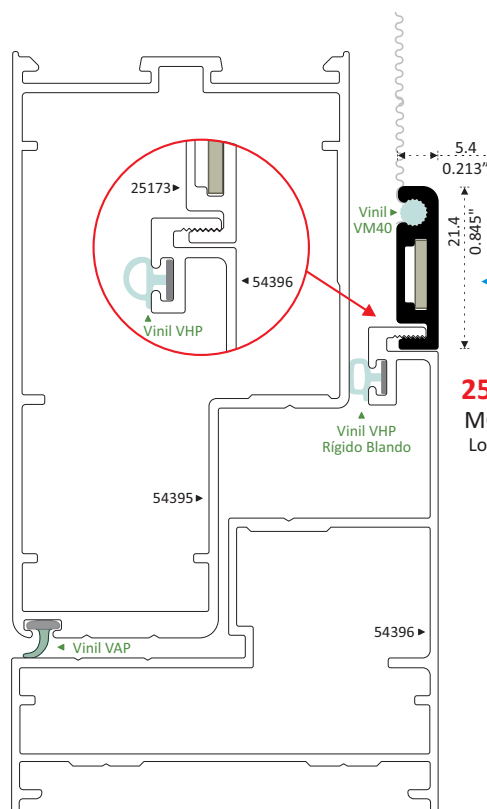

Estrías en Perfil y Vinil
Logrando Mayor Tensión
a la Tela Mosquitero
Sin Salirse de su Lugar

25173 PATENTE
MOSQUITERO
Longitud 6.10 m

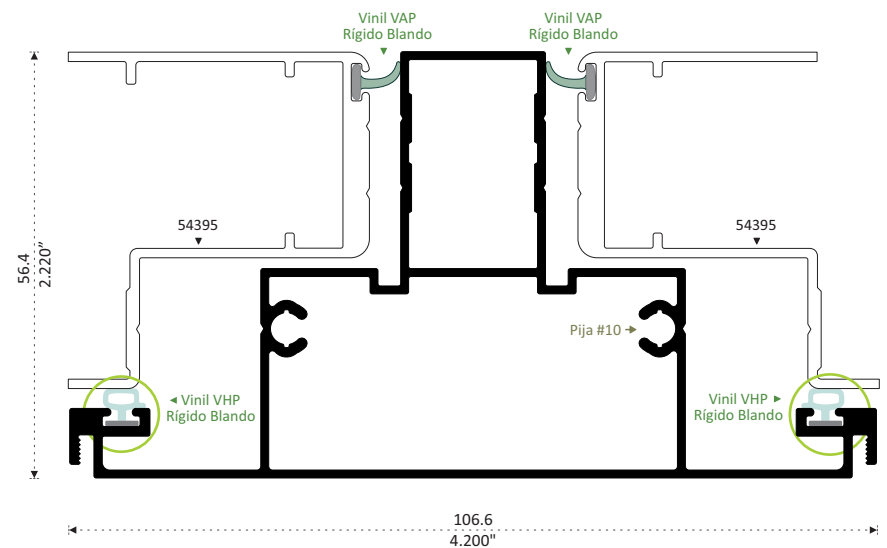

34397
INTERMEDIO
Longitud 6.10 m

Vinil Cuña

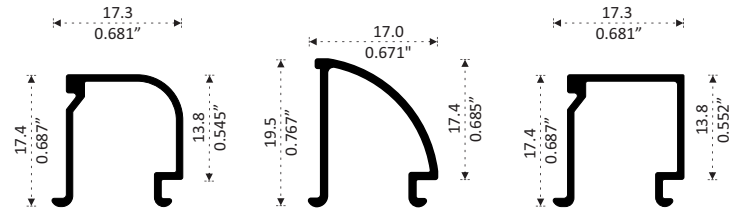

32576
JUNQUILLO COLONIAL
Longitud 6.10 m

14323 PATENTE
JUNQUILLO CURVO
Longitud 6.10 m

46370 PATENTE
JUNQUILLO RECTO
Longitud 6.10 m

Vinil Respaldo

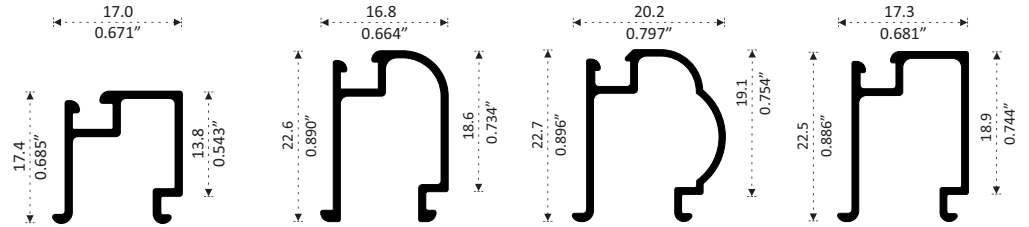

412543 PATENTE
JUNQUILLO
Longitud 6.10 m

22576
JUNQUILLO COLONIAL
Longitud: 6.10 m

412576 PATENTE
JUNQUILLO COLONIAL
Longitud 6.10 m

12543
JUNQUILLO
Longitud 6.10 m

Vinil Interior

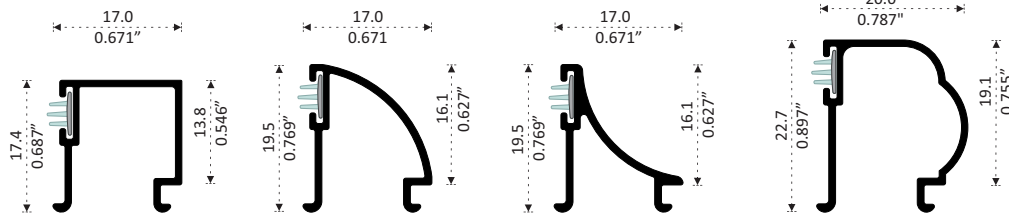

76370
JUNQUILLO
Longitud 6.10 m

24323
JUNQUILLO
Longitud 6.10 m

24324 PATENTE
JUNQUILLO
Longitud 6.10 m

24331 PATENTE
JUNQUILLO
Longitud 6.10 m

Marquetería

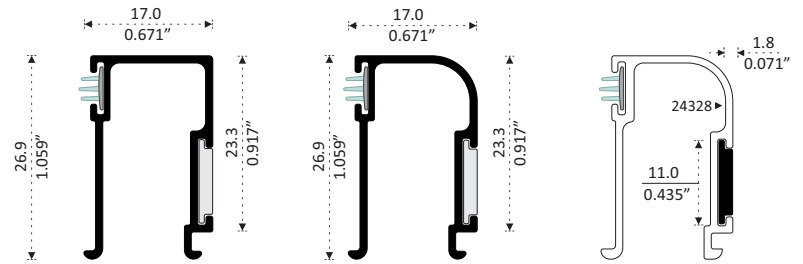

24327 PATENTE
JUNQUILLO MARQUETERÍA
Longitud 6.10 m

24328 PATENTE
JUNQUILLO MARQUETERÍA
Longitud 6.10 m

24330 PATENTE
BARRA MARQUETERÍA
Longitud 6.10 m



Cristal Doble

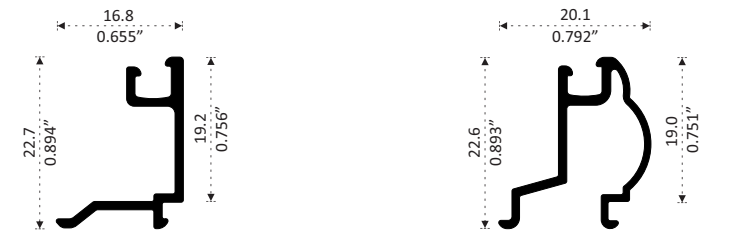

22603
JUNQUILLO CRISTAL DOBLE
Longitud 6.10 m

12604 PATENTE
JUNQUILLO COLONIAL CRISTAL DOBLE
Longitud 6.10 m

ASLAMIENTO ACÚSTICO
 REALIZADO CON 120 DECIBELES AL EXTERIOR
 MEDIDA 1.00 x 1.00 m

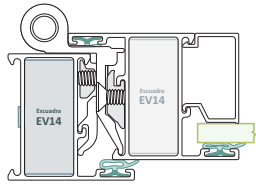

BATIENTE



Vinil
VH14

ASLAMIENTO

39.1
Decibeles

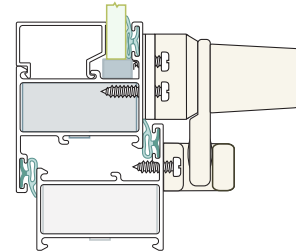

PROYECCIÓN



Vinil
VH14

ASLAMIENTO

41.7
Decibeles

PERMEABILIDAD AL AGUA DURANTE 20 MINUTOS

VENTANA MEDIDA 1.00 x 1.00 m

VELOCIDAD KM/H	Agua	Aire
20	50%	50%
40	50%	50%
60	50%	50%
80	50%	50%
100	50%	50%
120	60%	40%

SIN MOSQUITERO

Sin
Filtraciones

MOSQUITERO BATIENTE
MULTILINEAS

Sin
Filtraciones

PERMEABILIDAD AL VIENTO Medida 1.00 x 1.00 m

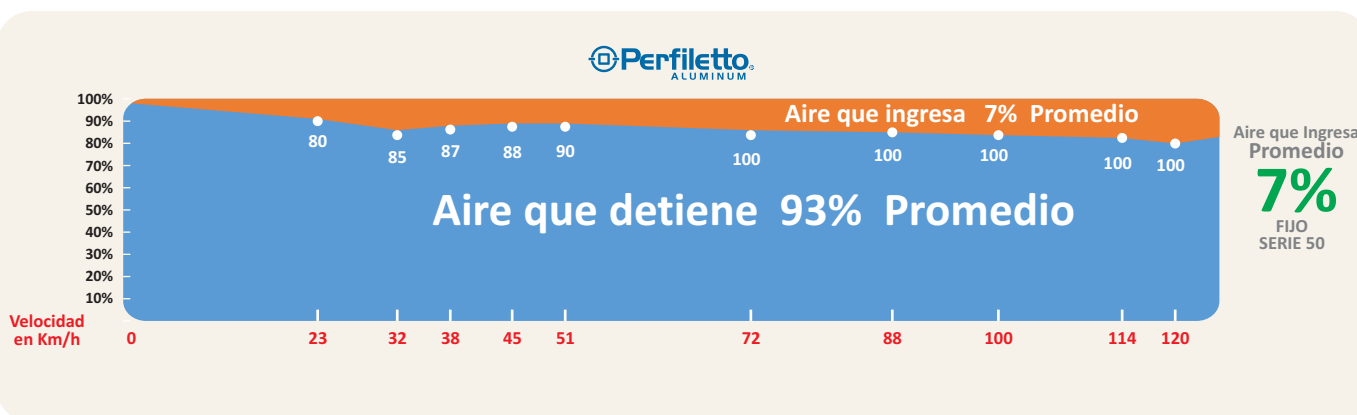

RESISTENCIAS A VIENTOS

VENTANA

Prueba Realizada
30 Repeticiones de 1 Minuto c/u
A 100 Km/h

Medida 1.00 x 1.00 m
 Cristal 6 mm

LOS PERFILES SIN DEFORMACIÓN
CONSERVAN SU
FUNCIONAMIENTO

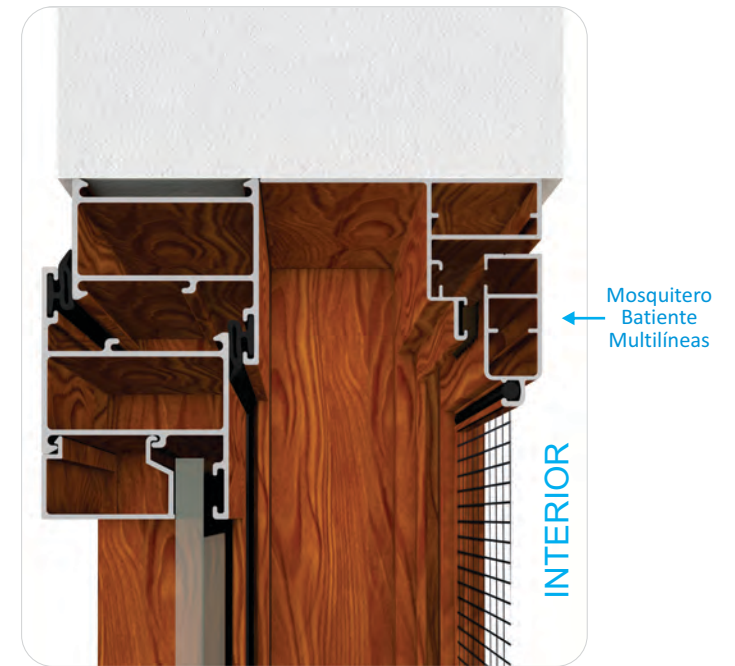
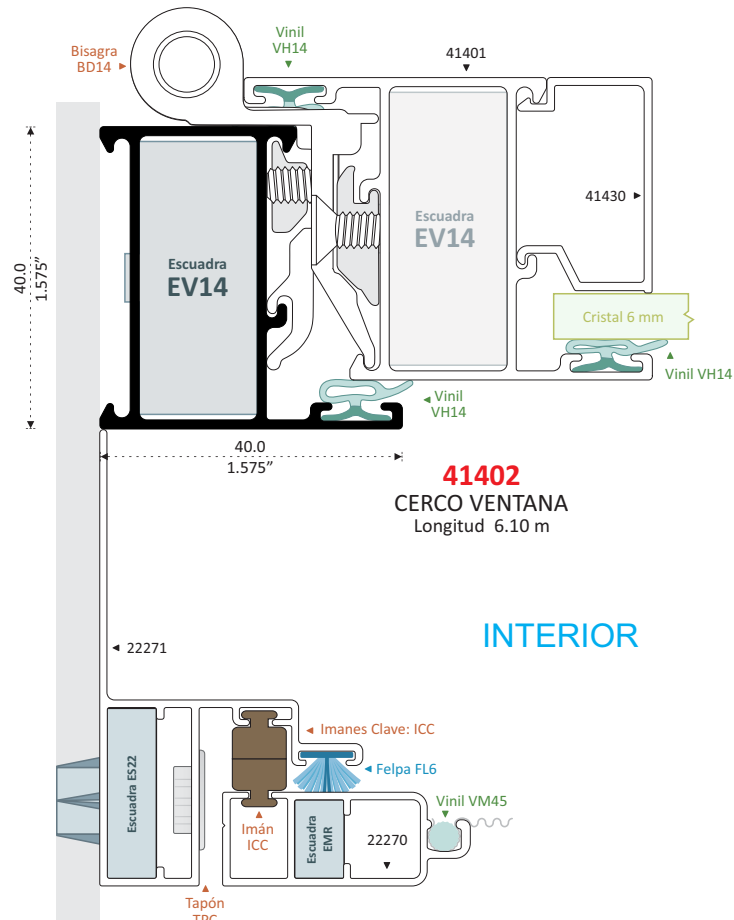

41401 HOJA VENTANA
Longitud 6.10 m

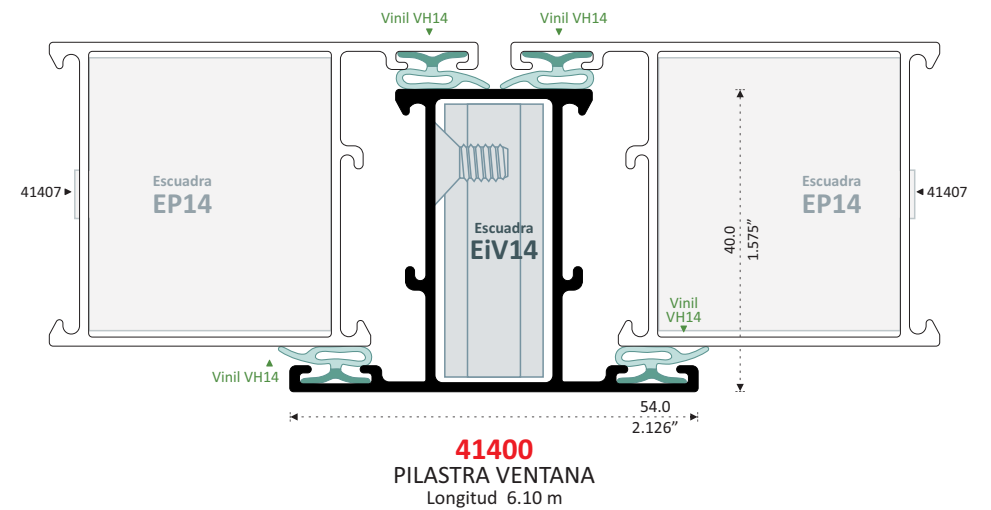
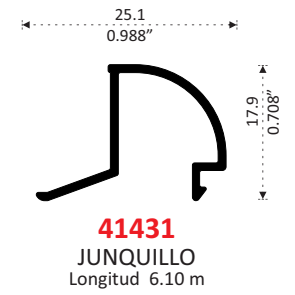
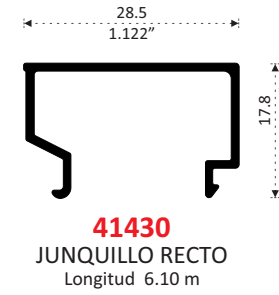
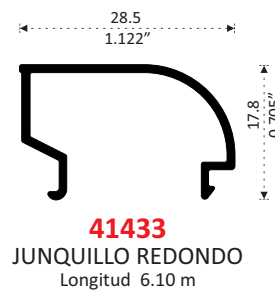
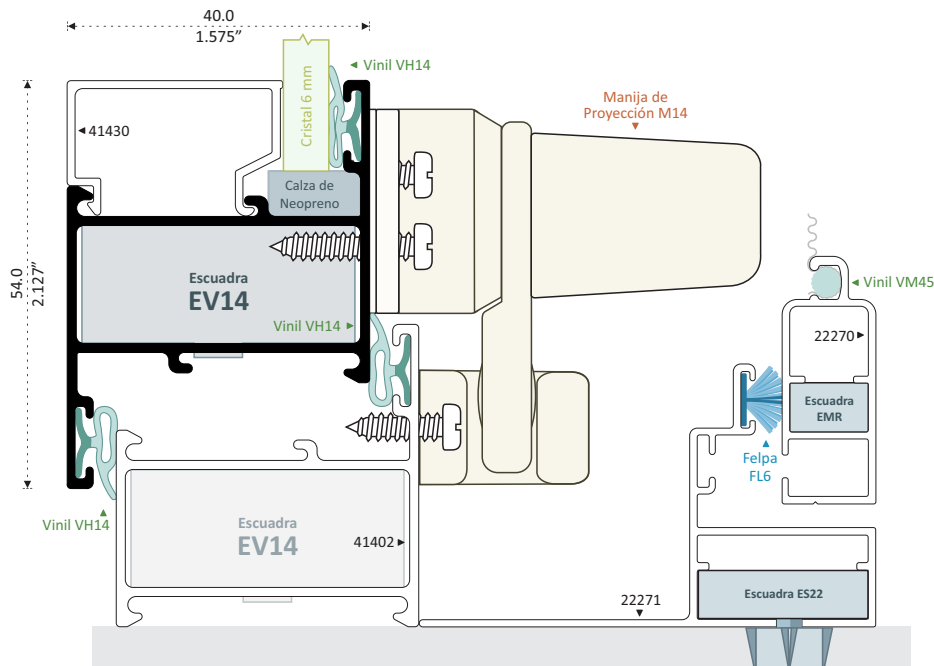

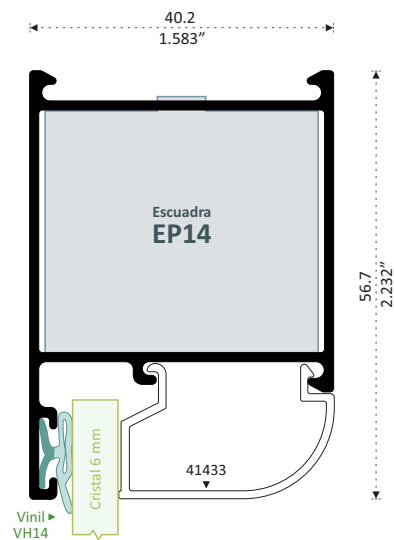

41407
CERCO PUERTA
Longitud 6.10 m

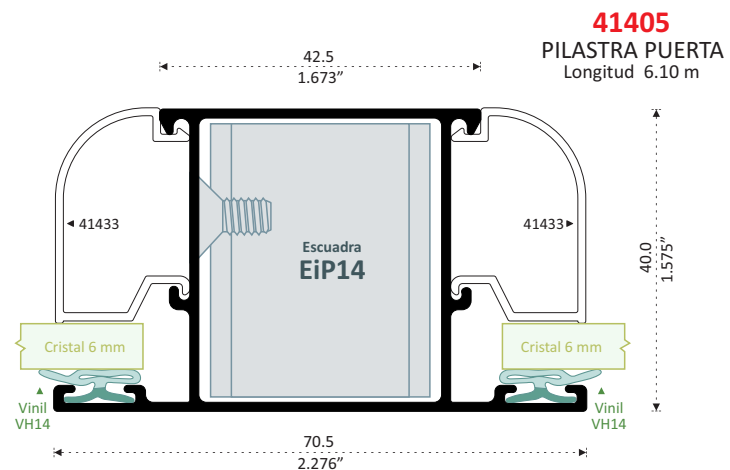

41405
PILASTRA PUERTA
Longitud 6.10 m

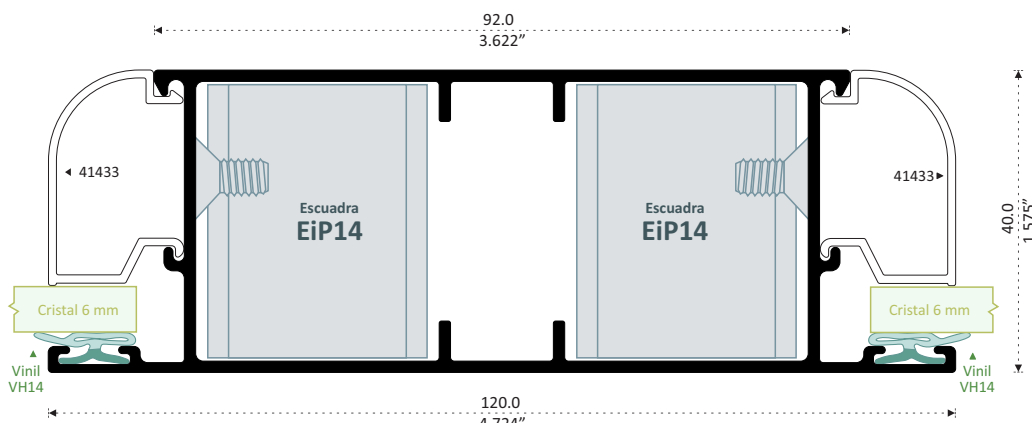

41423
PILASTRA GRAN VISTA
Longitud 6.10 m

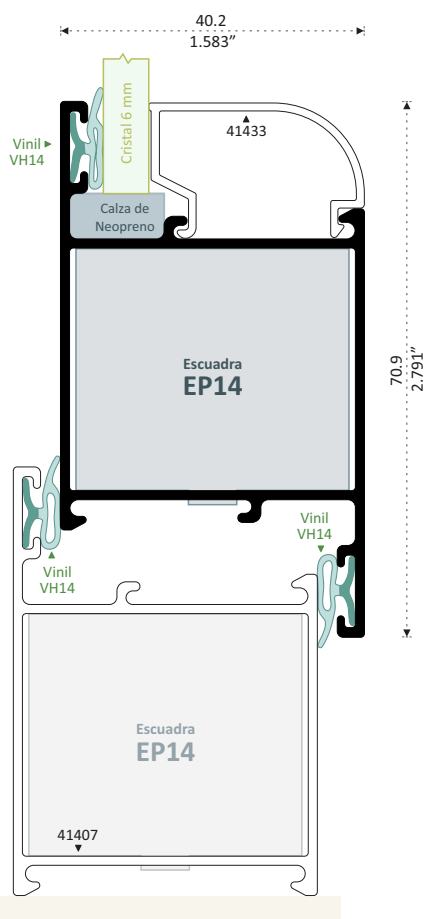

41406
HOJA PUERTA
Longitud 6.10 m

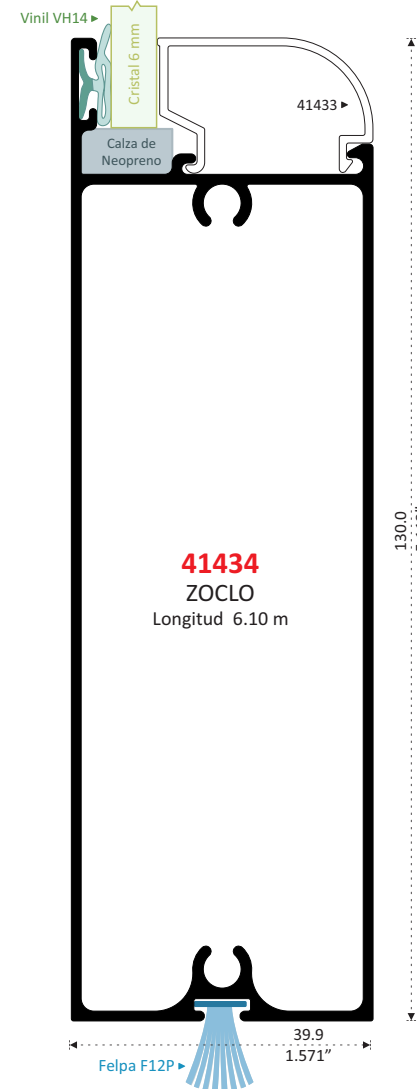
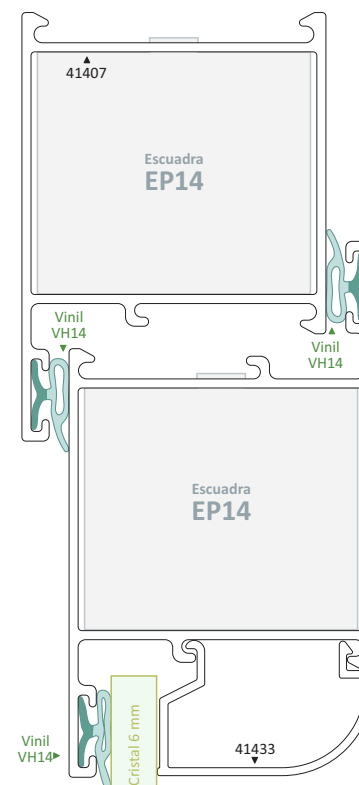

41434
ZOCLO
Longitud 6.10 m



VENTANA GUILLOTINA CON CADENA

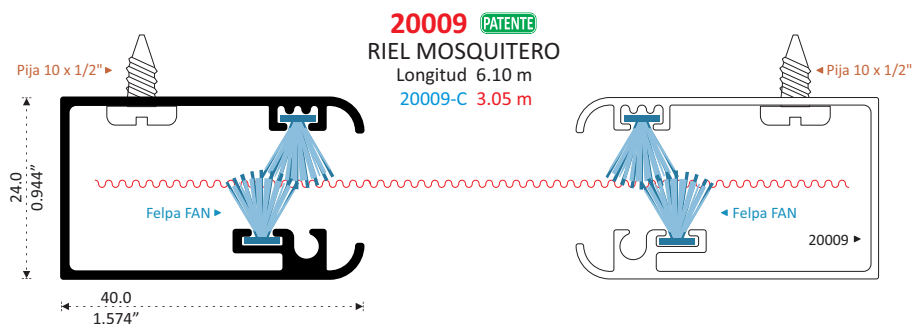

20009 PATENTE
RIEL MOSQUITERO
Longitud 6.10 m
20009-C 3.05 m

ANCHO: 120 cm MÁXIMO
ALTURA: 120 cm MÁXIMO

RESORTE DE 42 cm

- R42D Derecho
- R42I Izquierdo

RESORTE DE 150 cm

- R150D Derecho
- R150I Izquierdo

Guía Perfil 20001

	Largo	Enrollado
ME12	1.20 m	1.50 m
ME15	1.50 m	1.50 m
20006C	5.80 m	1.50 m
20006	5.80 m	2.40 m

20.0
0.787"

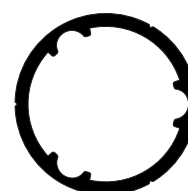

20001
TUBO CON GUÍAS
Longitud 6.00 m

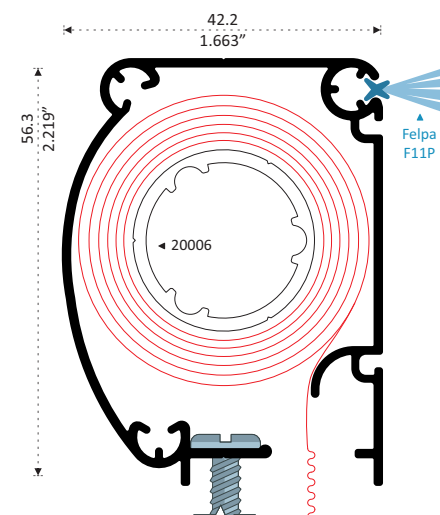

20010 PATENTE
CAJÓN MOSQUITERO
Longitud 6.10 m
20010-C 3.05 m

Nota: El Resorte de 150 cm Lo Puede Recortar a la Medida Necesaria
Su Funcionamiento es Mejor Si el Resorte es lo más Grande Posible

VENTANA CORREDIZO

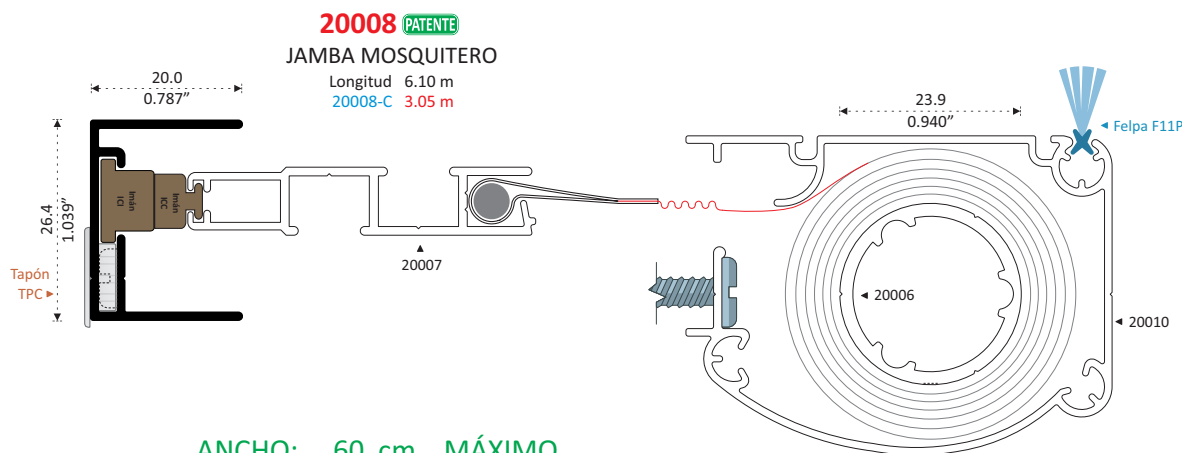

20008 PATENTE
JAMBA MOSQUITERO
Longitud 6.10 m
20008-C 3.05 m

ANCHO: 60 cm MÁXIMO
ALTURA: 120 cm MÁXIMO

RESORTE DE 42 cm

- R42D Derecho
- R42I Izquierdo

RESORTE DE 150 cm

- R150D Derecho
- R150I Izquierdo

Nota: El Resorte de 150 cm Lo Puede Recortar a la Medida Necesaria
Su Funcionamiento es Mejor Si el Resorte es lo más Grande Posible

El Resorte : Se Instala en la Parte Superior

20007
CERCO JALADERA VENTANA
Longitud 6.10 m
20007-C 3.05 m

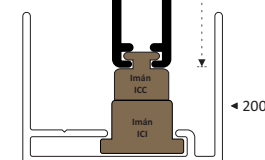

PUERTA GUILLOTINA CON CADENA

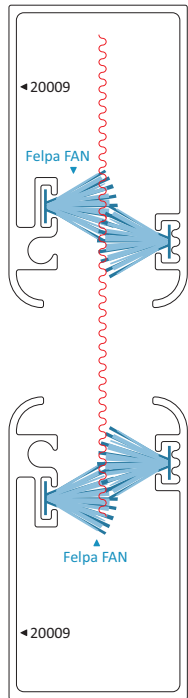

RESORTE 150 cm

ANCHO: 160 cm MÁXIMO

ALTURA: 240 cm MÁXIMO

RESORTE 150 cm

Con Guía 30001

ANCHO: 200 cm MÁXIMO

ALTURA: 240 cm MÁXIMO

R150D Derecho R150I Izquierdo

Nota: El Resorte de 150 cm
Lo Puede Recortar a la Medida Necesaria,

Su Funcionamiento es Mejor
Si el Resorte es lo más Grande Posible

Guía Perfil 30001	Largo Enrollado	
	ME20	ME200
	2.00 m	1.50 m
	2.00 m	2.40 m
	3.00 m	2.40 m
	5.80 m	2.40 m

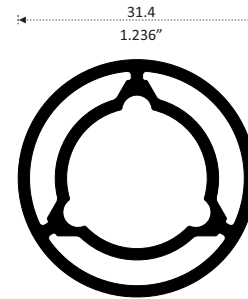

30001
TUBO CON GUÍAS
Longitud 6.00 m

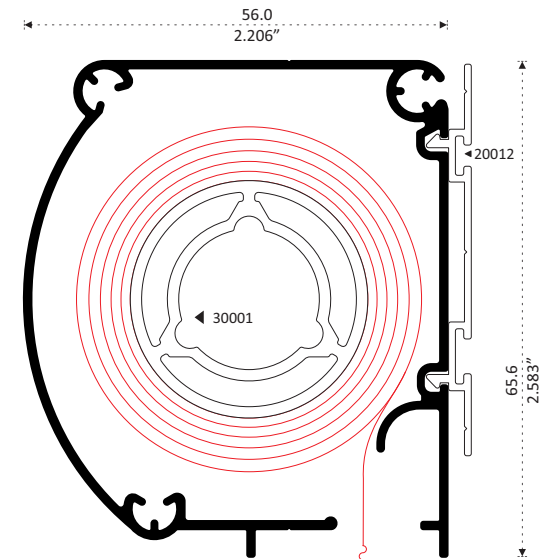

20011 PATENTE
CAJÓN PUERTA
Longitud 6.10 m
20011-C 3.05 m

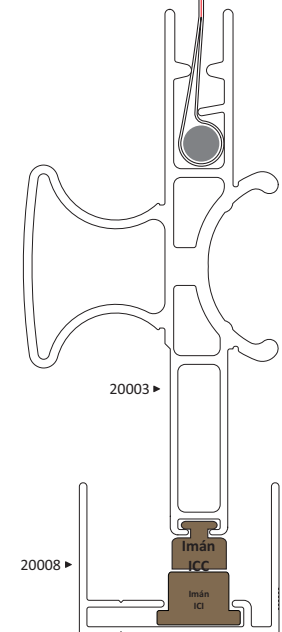

PUERTA CORREDIZO

RESORTE 150 cm

ANCHO: 130 cm MÁXIMO

ALTURA: 240 cm MÁXIMO

R150D Derecho R150I Izquierdo

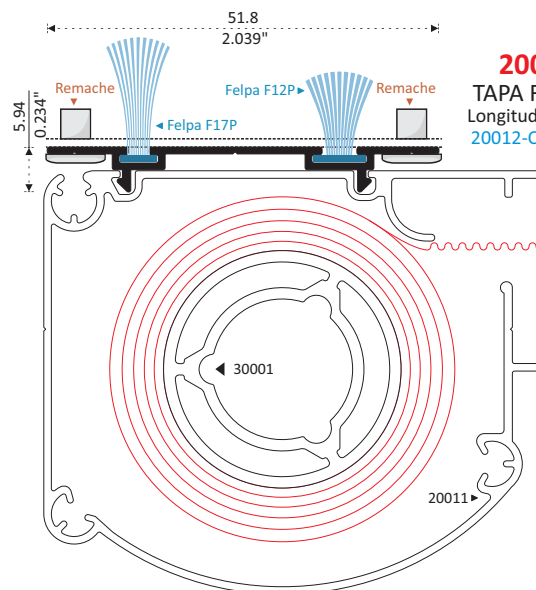

20012
TAPA FELPAS
Longitud 6.10 m
20012-C 3.05 m

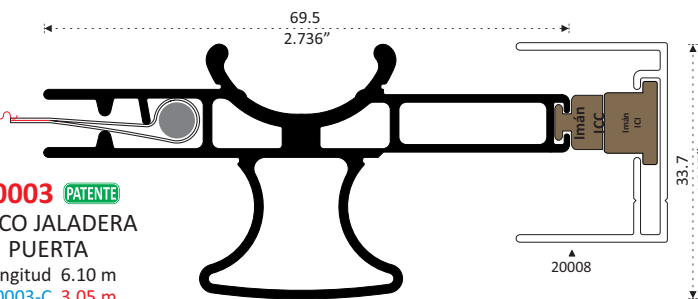

20003 PATENTE
CERCO JALADERA
PUERTA
Longitud 6.10 m
20003-C 3.05 m

Nota: El Resorte de 150 cm Lo Puede Recortar a la Medida Necesaria

Su Funcionamiento es Mejor Si el Resorte es lo más Grande Posible

El Resorte: Se Instala en la Parte Superior

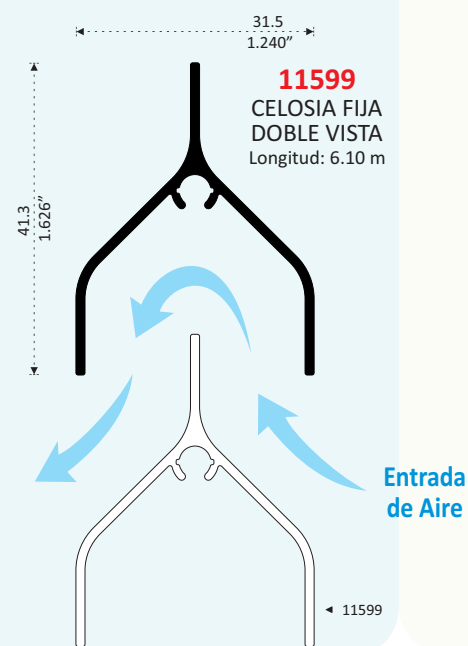
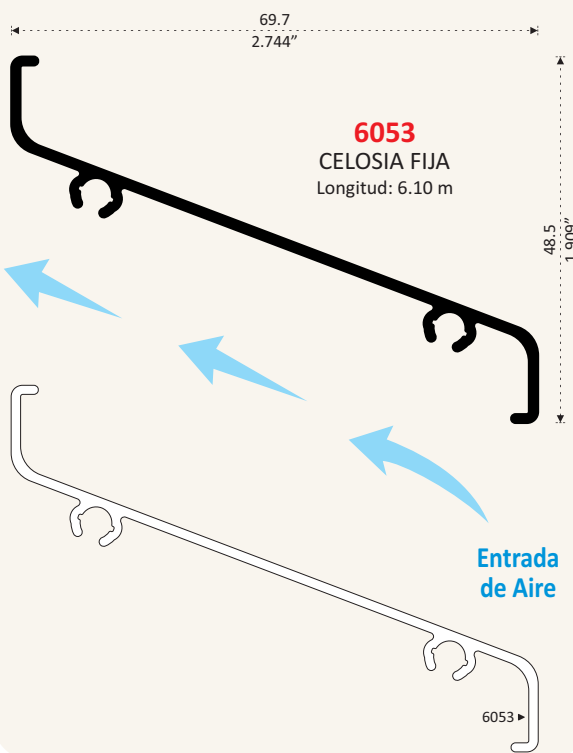
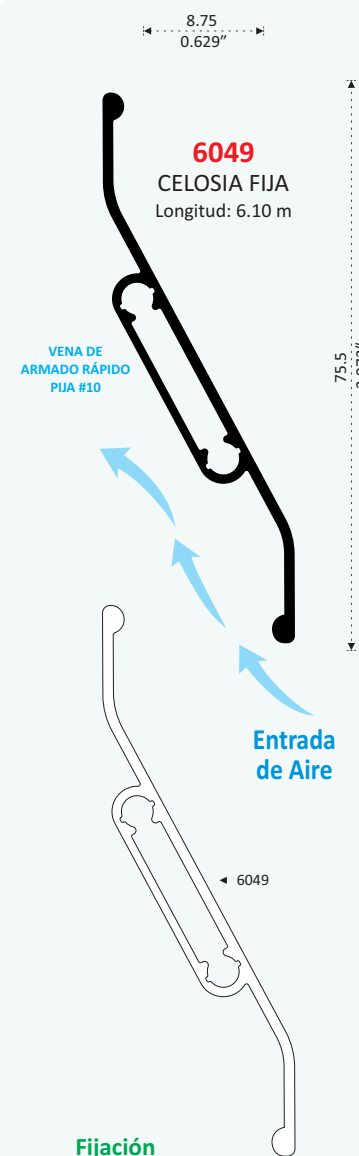
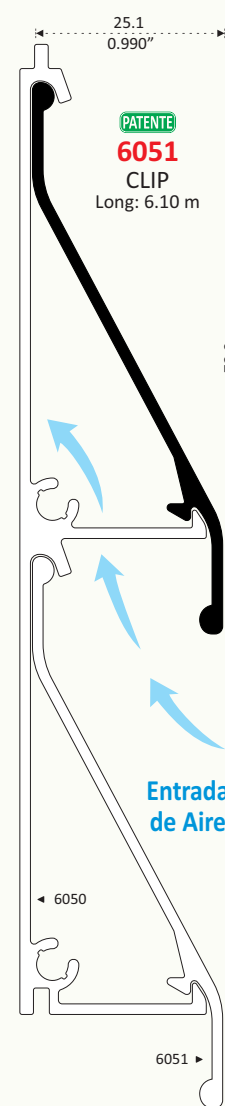
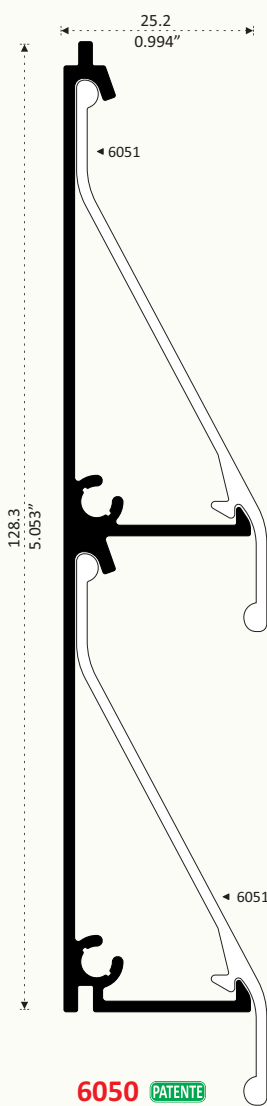
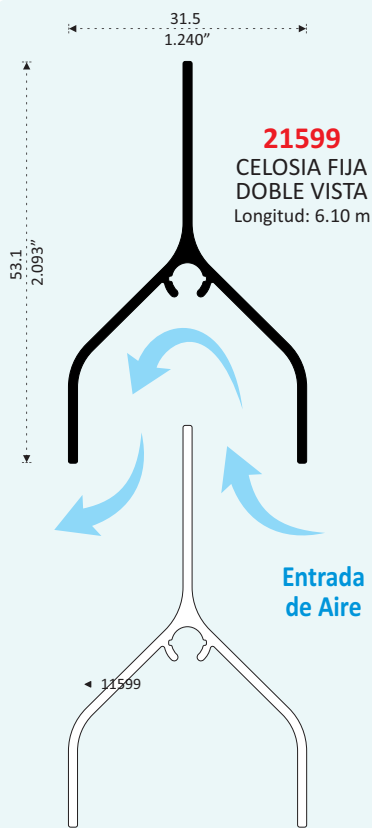

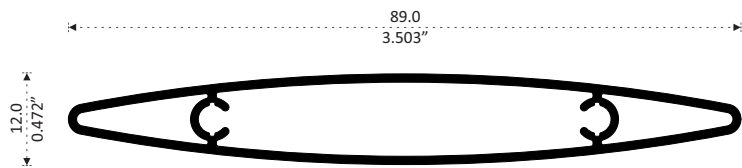

66054 PATENTE
ROMPE VISTA
Longitud: 6.10 m

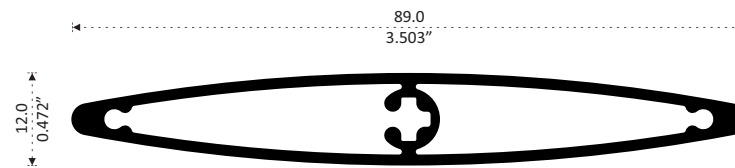

6054
ROMPE VISTA
Longitud: 6.10 m



Ensamble de Rompe Vista 66054
con Tapa Lisa 4049
Puerta Multidiseños

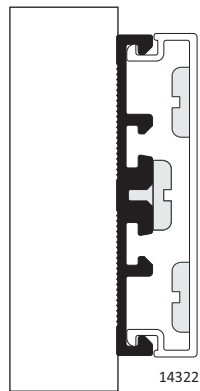

**COLOCACIÓN
A MURO**

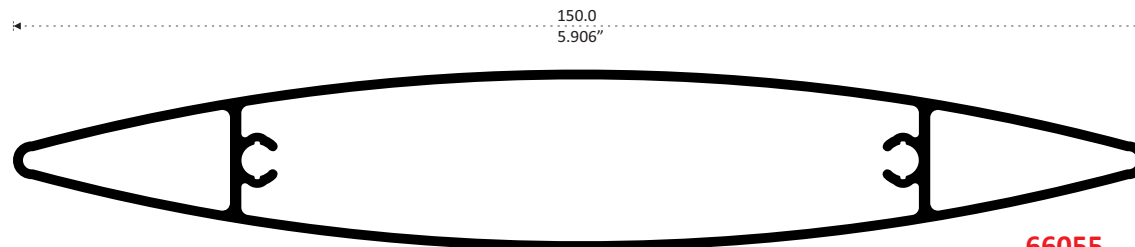

66055
ROMPE VISTA
Longitud: 6.10 m

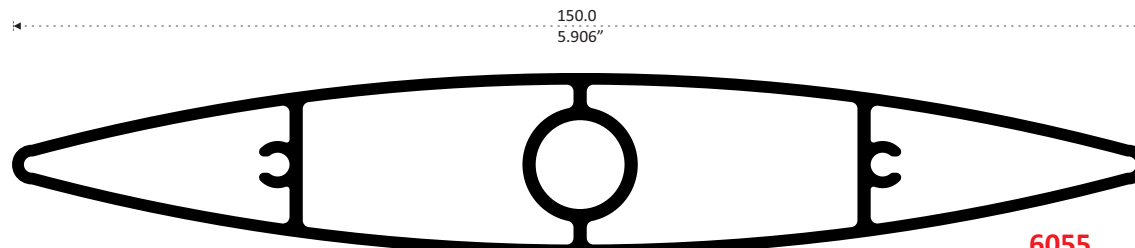

6055
ROMPE VISTA
Longitud: 6.10 m

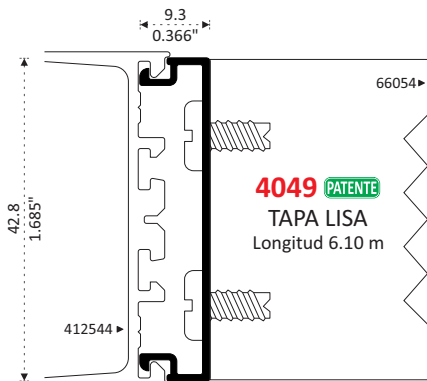

4049 PATENTE
TAPA LISA
Longitud 6.10 m

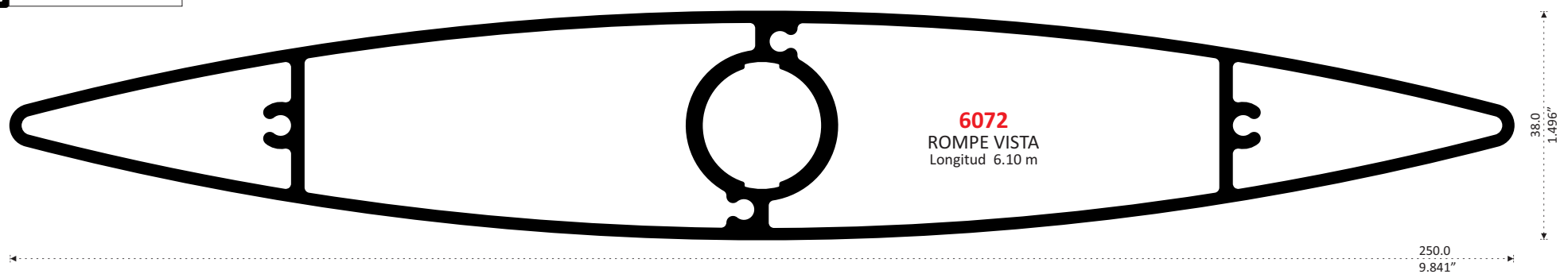

6072
ROMPE VISTA
Longitud 6.10 m

Escala
50% del Tamaño Real

6082
ROMPE VISTA
Longitud : 6.10 m.

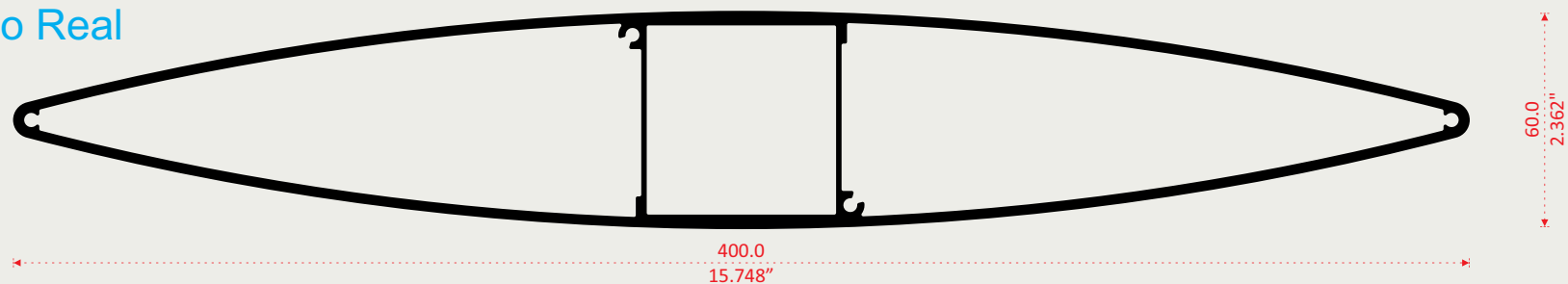

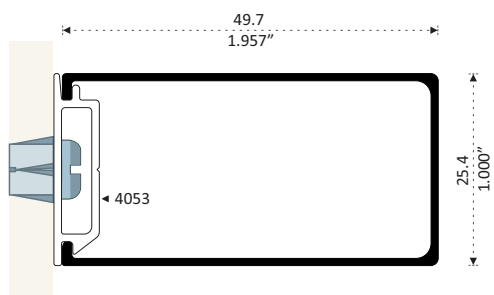

72521
ROMPE VISTA
Longitud 6.10 m

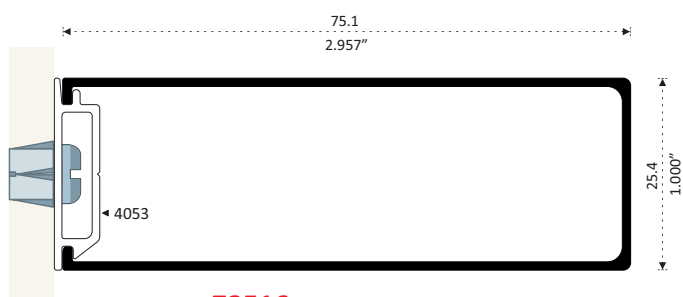

72516
ROMPE VISTA
Longitud 6.10 m



TAPAS ROMPE VISTAS

Instalación en Perfil 72521



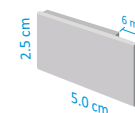

Instalación en Perfil 72516

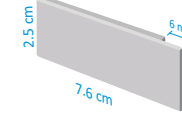

TR2
2"



TR3
3"

- 
Natural
- 
Andiroba
Text.
- 
Nogal
Text.
- 
Cerezo
Text.

VISTA ELEGANTE

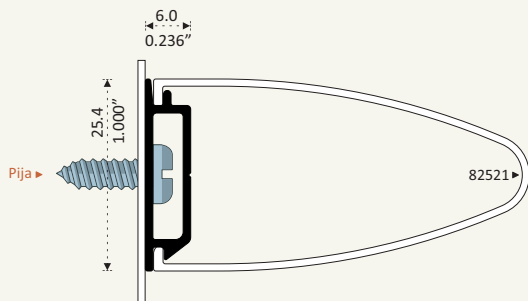

4053
TAPA ROMPE VISTA
Longitud 6.10 m

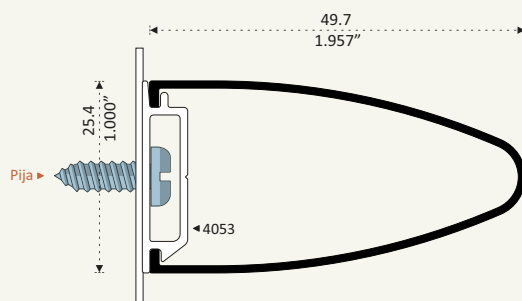

82521
ROMPE VISTA
Longitud 6.10 m



Fijación de Tapa Rompe Vista
82521

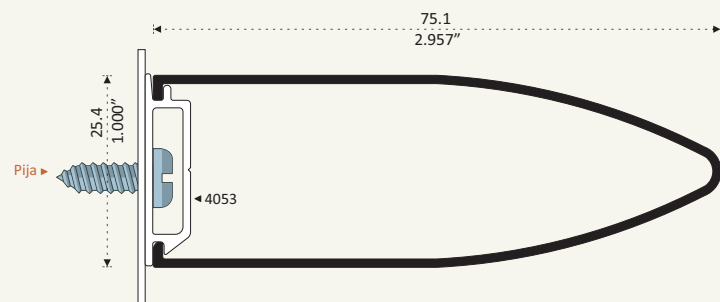

82516
ROMPE VISTA
Longitud 6.10 m

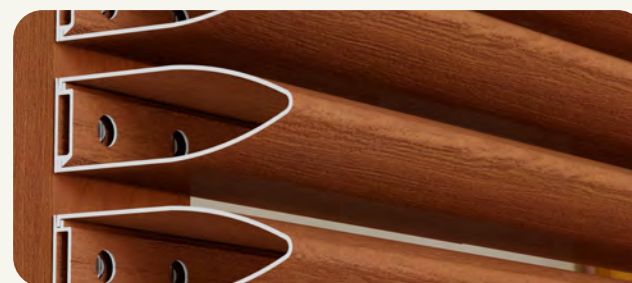

Fijación de Tapa Rompe Vista
82516

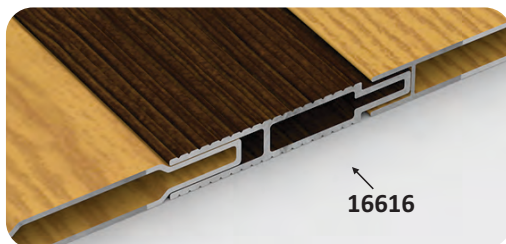

16616

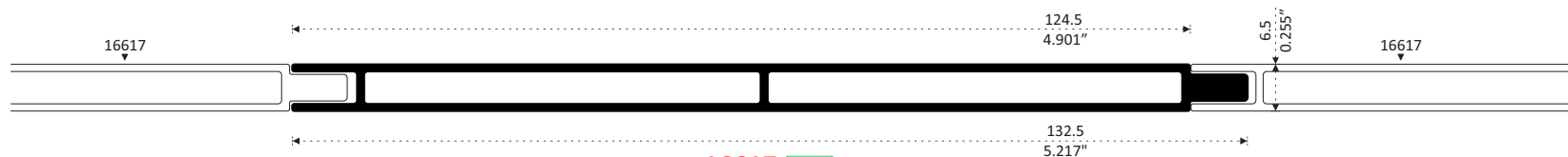

16617 PATENTE
DUELA LISA DOBLE VISTA 5"
Longitud : 6.10 m
16617-C 4.60 m
16617-5 5.00 m

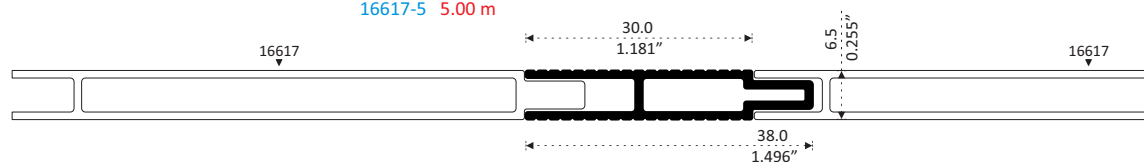

16616
DUELA ESTRIADA DOBLE VISTA
Longitud : 6.10 m

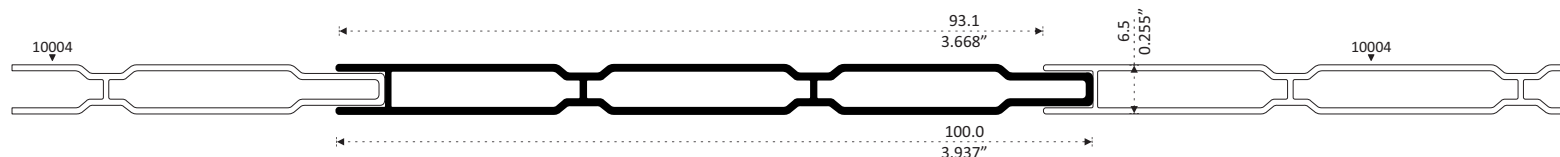

10004 PATENTE
DUELA DOBLE VISTA
Longitud 6.10 m
10004-5 5.00 m

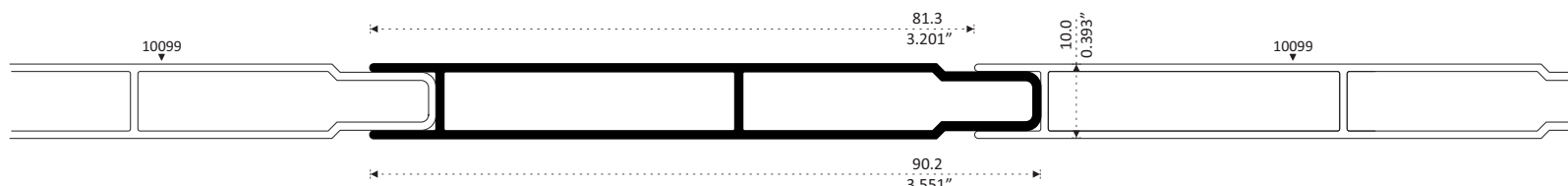

10099 PATENTE
DUELA PARKET DOBLE VISTA
Longitud : 6.10 m
10099-C 3.05 m
10099-5 5.00 m

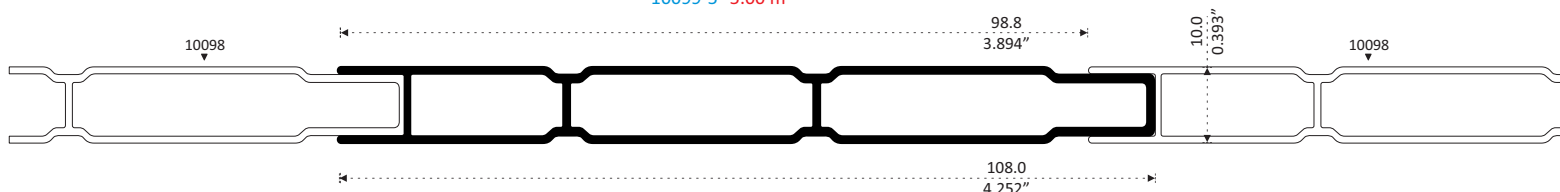

10098 PATENTE
DUELA DOBLE VISTA
Longitud 6.10 m
10098-5 5.00 m

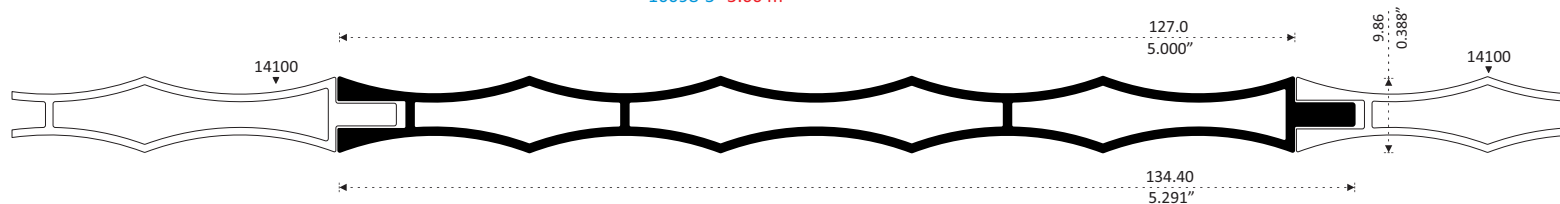

14100 PATENTE
DUELA CINCO ONDAS DOBLE VISTA 5"
Longitud : 6.10 m
14100-5 5.00 m



6617
DUELA LISA
Longitud: 6.10 m
6617-C 4.60 m



76617
DUELA LISA
Longitud: 6.10 m



NUEVO 26617
DUELA LISA
Longitud: 6.10 m

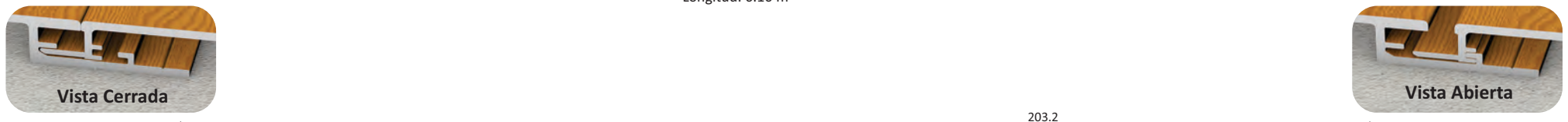

96617 PATENTE
DUELA LISA
Longitud: 6.10 m

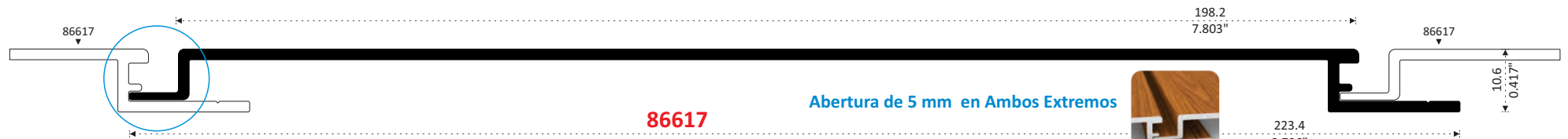

86617
DUELA LISA 8\"/>
Longitud: 6.10 m

Abertura de 5 mm en Ambos Extremos



Para Obtener el precio de 2 x 1 en Sublimado ó Pintado Agregue "MD" al final de la Clave

- Duelas: **6617**
- 26617**
- 66617**
- 76617**
- 86617**
- 96617**



Duela 2
Acabado
Una Vista



4100
DUELA CINCO ONDAS
Longitud: 6.10 m
4100-5 5.00 m



11130
DUELA TRAPECIO 6\"/>
Longitud: 6.10 m

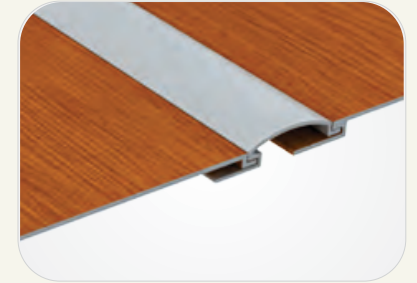
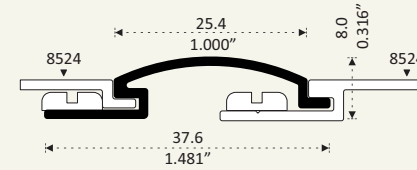
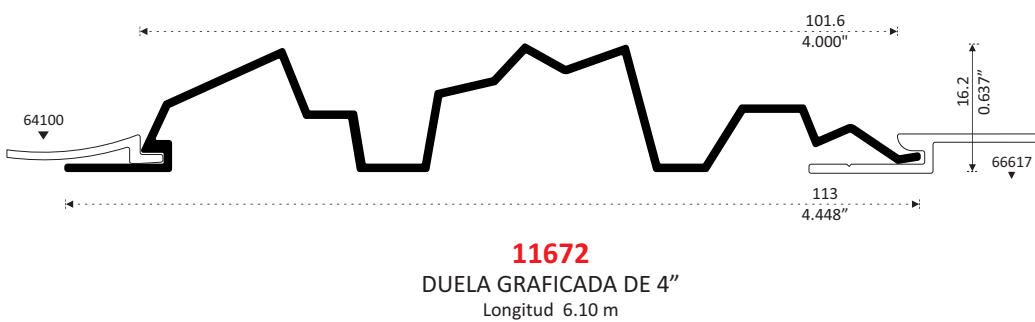
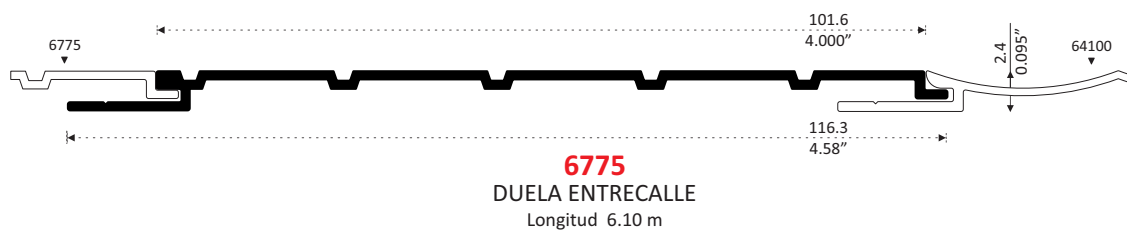
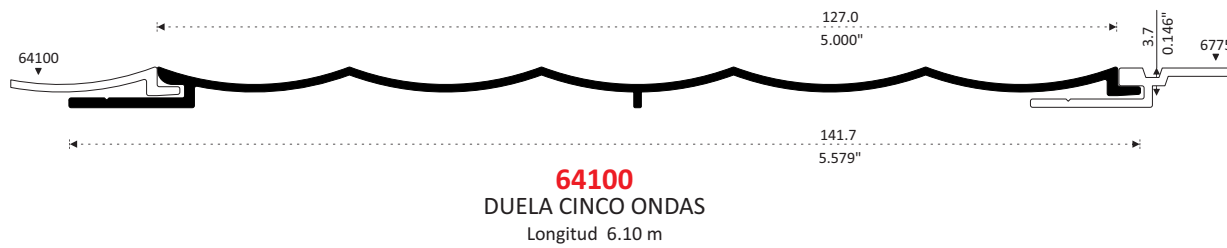

Duela Lisa 8524
en Combinación con Moldura 8521

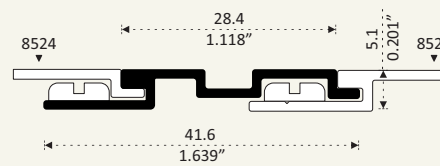

Duela Lisa 8524
en Combinación con Moldura 8520

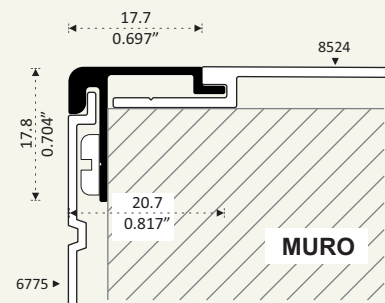

Colocación Duela Vertical

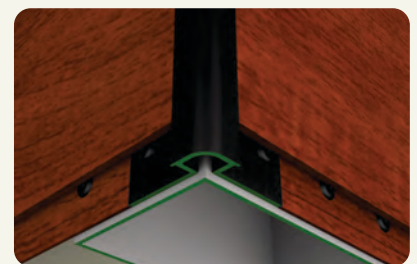
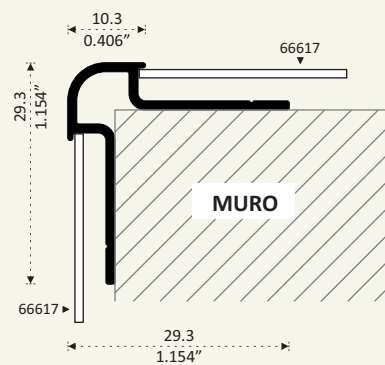

Colocación Duela Horizontal

SOLERA PARA SU ATORNILLADO ENTRA JUSTA

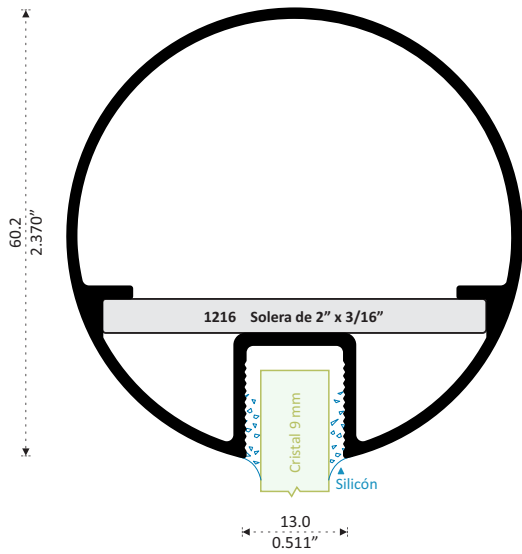

623896
PASAMANOS 2.3"
Longitud 6.10 m

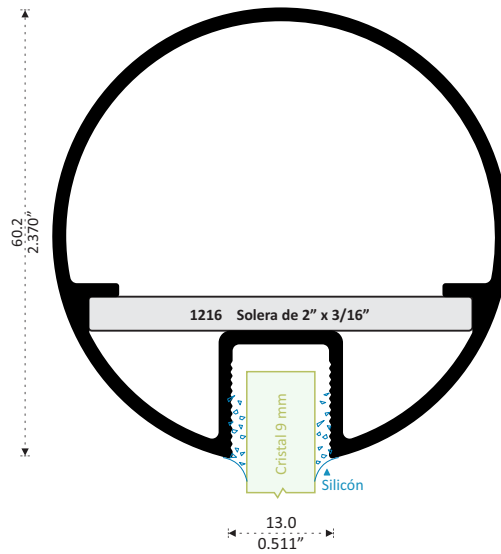

23896
PASAMANOS 2.3"
Longitud 6.10 m

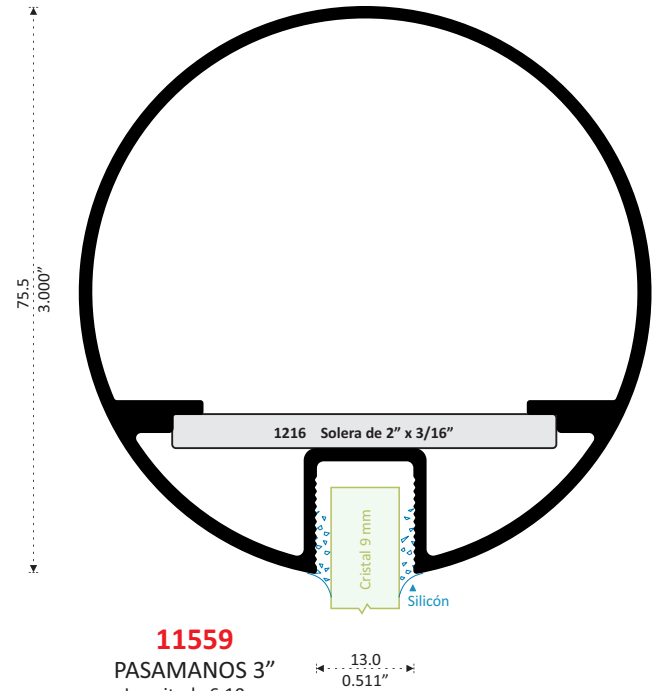

11559
PASAMANOS 3"
Longitud 6.10 m
11559-C 4.60 m

COMBINABLE CON PASAMANOS:

- 623896
- 23896
- 11559

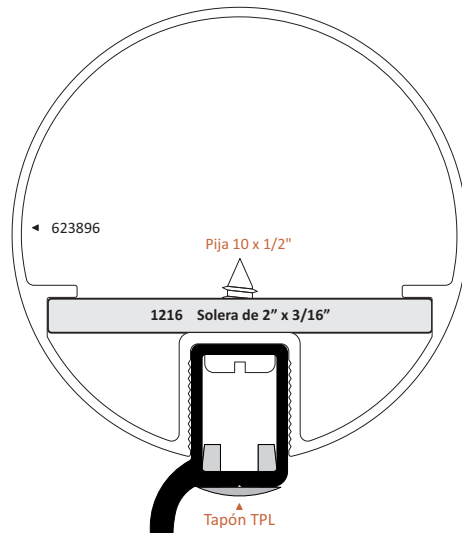

Disponibles como Herrajes :
SP 10 cm
SPM 1 m

11560 PATENTE
SOPORTE PASAMANOS
Longitud 6.10 m

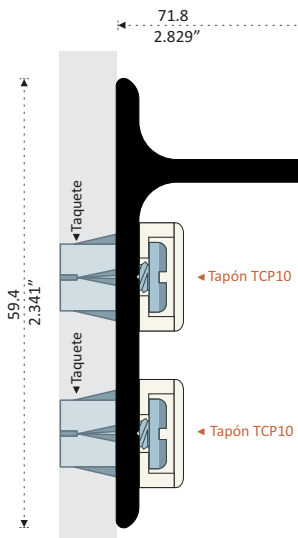

NUEVO

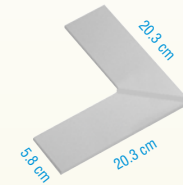

EP Escuadra Pasamanos

COMBINABLE CON:

11559

23896

623896



Tapa para Pasamanos Redondo



Acabado Aluminio

	Interior	Exterior
TP2 Para Perfil 23896 / 623896	6 cm.	6.7 cm.
TP3 Para Perfil 11559	7.5 cm.	8.2 cm.
TP4 Para Perfil 11945	10 cm.	10.7 cm.



TP2C
Caja 10 Piezas

TP2G
Caja 20 Piezas



TP3C
Caja 10 Piezas

TP3G
Caja 20 Piezas



TP4C
Caja 10 Piezas

TP4G
Caja 20 Piezas

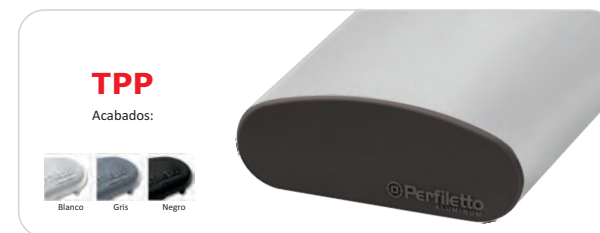
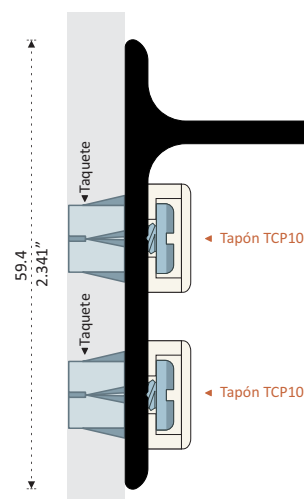
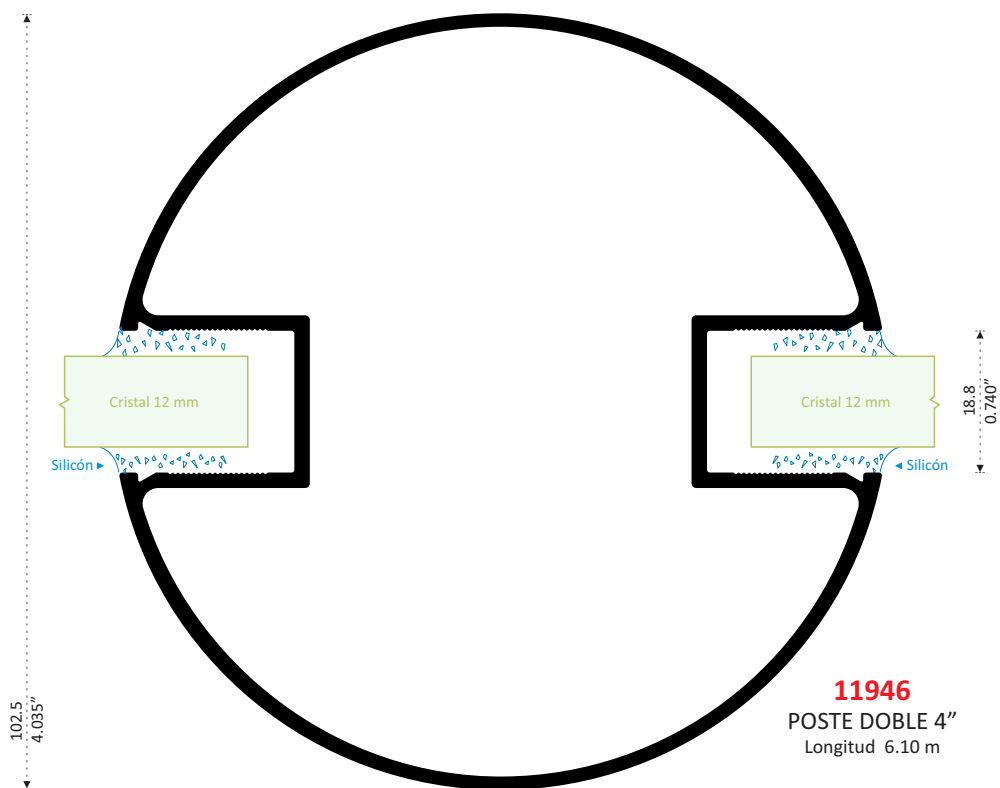
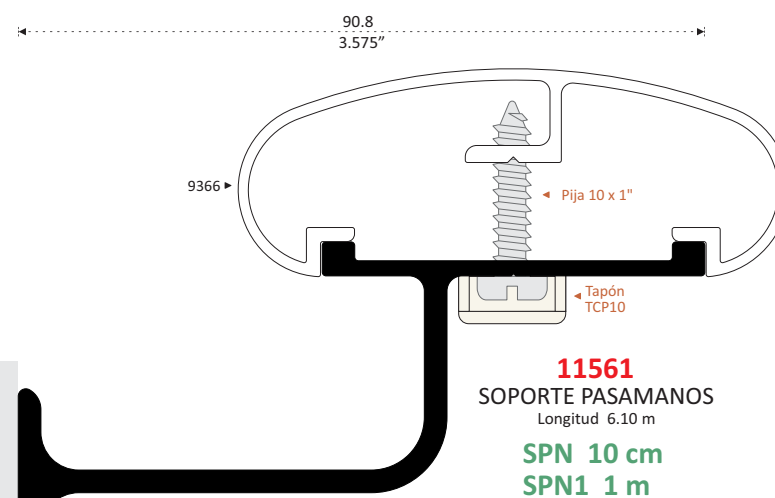
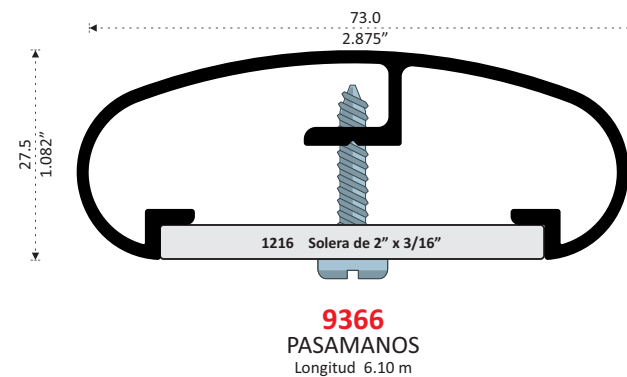
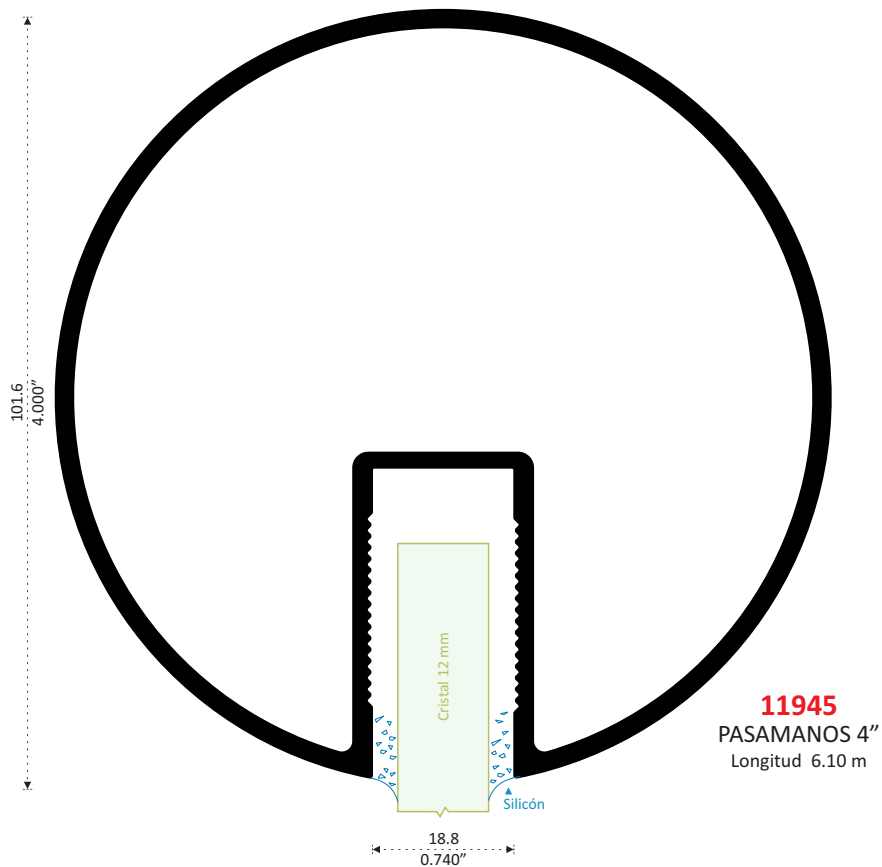

Tapa para Pasamanos Ovalado

RECIBE:

CON CRISTAL DE 10 mm
VINIL CUÑA AMBOS LADOS VC11

CON CRISTAL DE 12 mm
VINIL CUÑA AMBOS LADOS VC177P

YESO PIEDRA 2797

CALZAS PARA 10 Y 12 mm
CALZA 10 mm: CG10
CALZA 12 mm: CG12

SELLOS DE HERMETICIDAD :
49188 UNA FELPA
19188 TRES FELPAS

ESPACIO ADECUADO
PARA BRAZOS DE
BISAGRA HIDRÁULICA 1999P

CHAPA DE PALETA 326

TAPAS PLÁSTICAS TZP

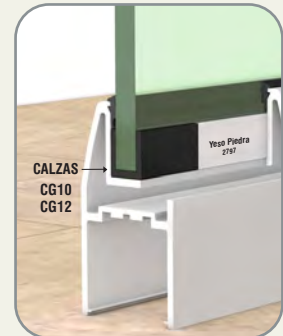
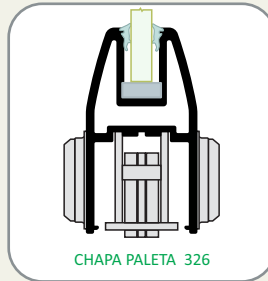
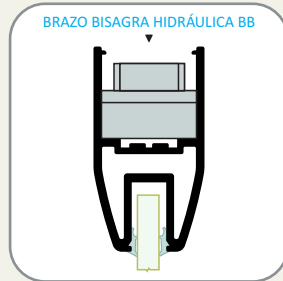

Facilita la Colocación del Cristal con la Retención del Yeso Piedra

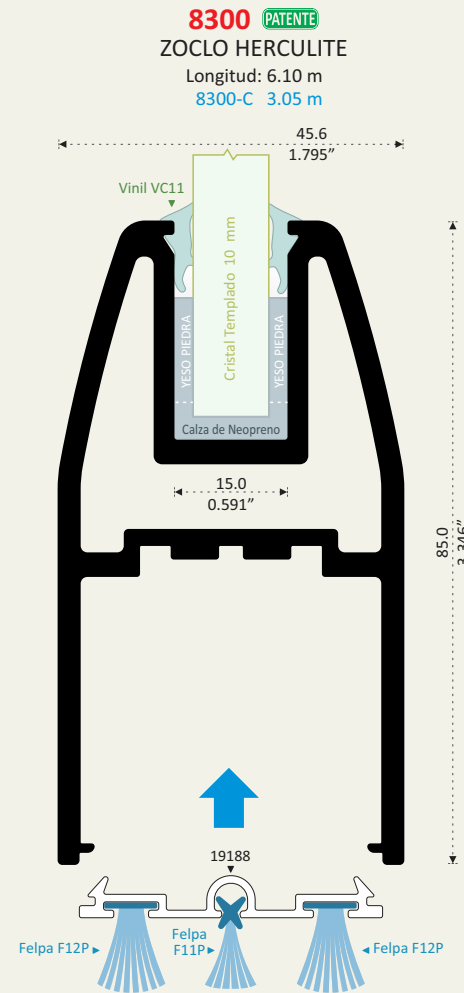

MEJOR PRECIO

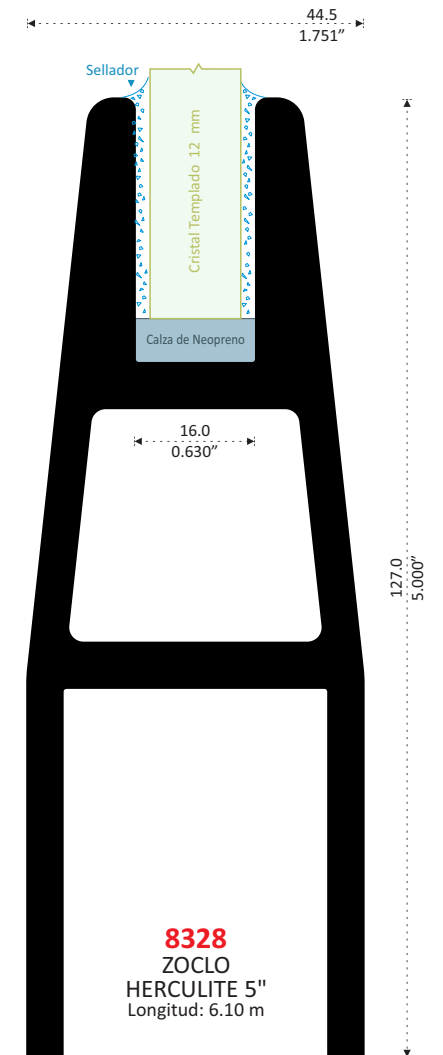

SISTEMA CORREDIZO

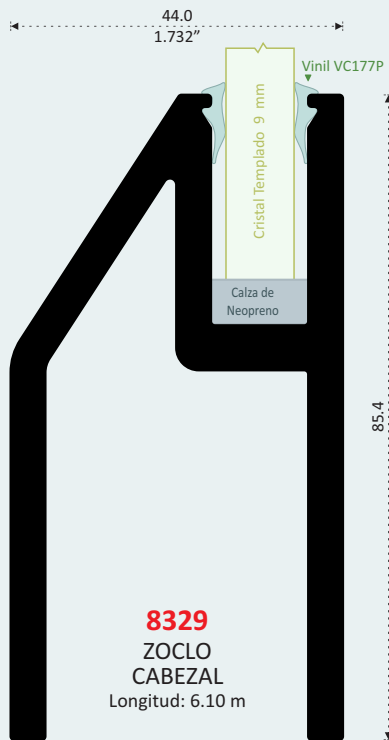

8329
ZOCLO
CABEZAL
Longitud: 6.10 m

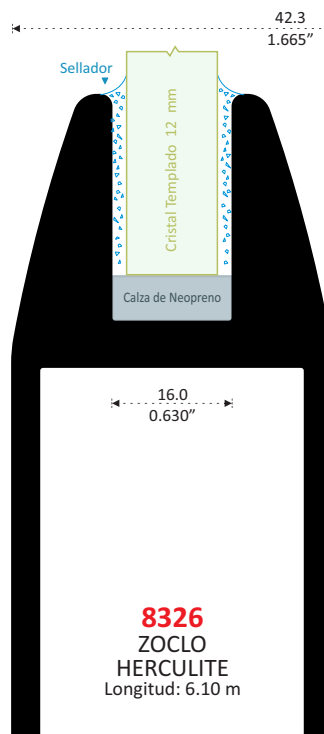

8326
ZOCLO
HERCULITE
Longitud: 6.10 m

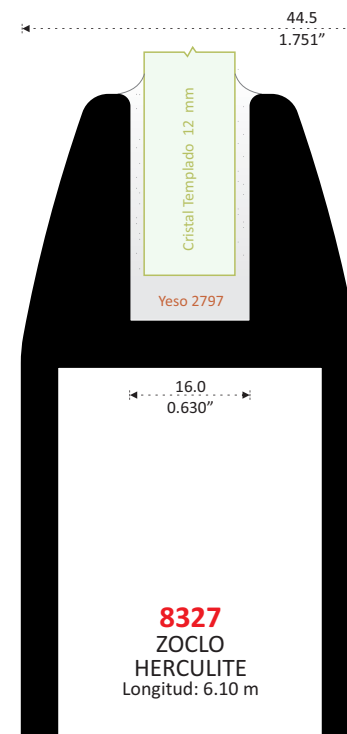

8327
ZOCLO
HERCULITE
Longitud: 6.10 m

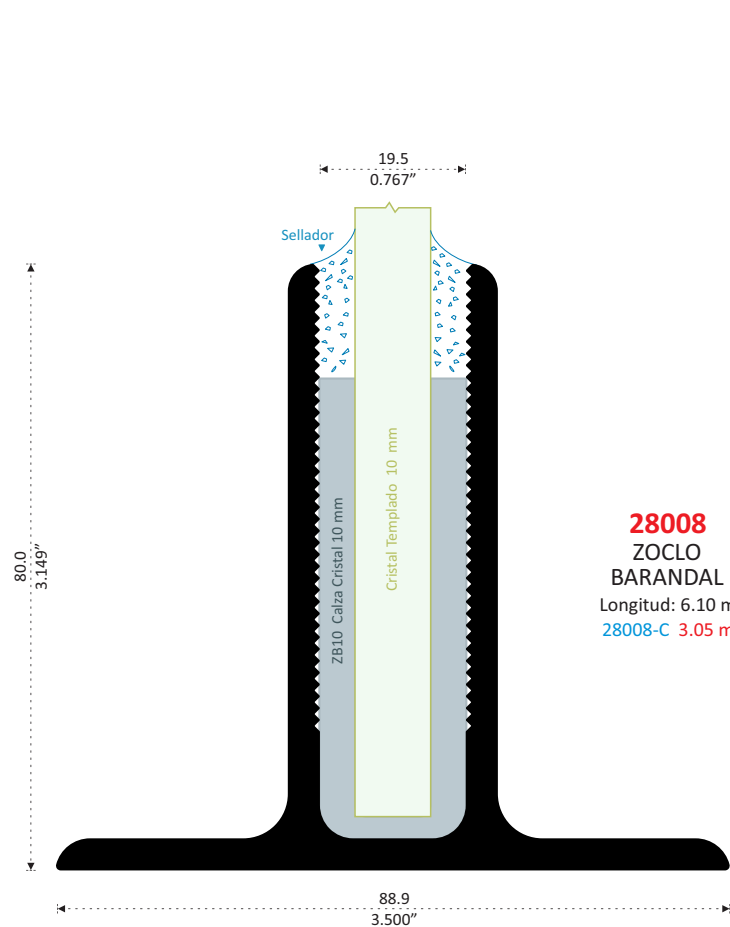

28008
ZOCLO
BARANDAL
Longitud: 6.10 m
28008-C 3.05 m

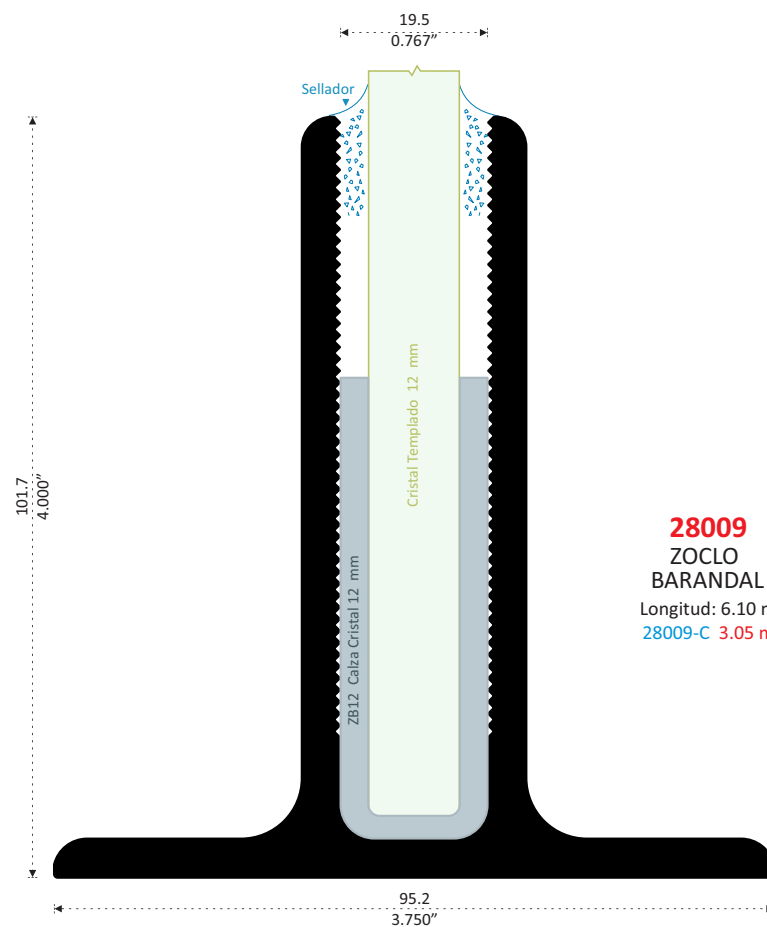

28009
ZOCLO
BARANDAL
Longitud: 6.10 m
28009-C 3.05 m

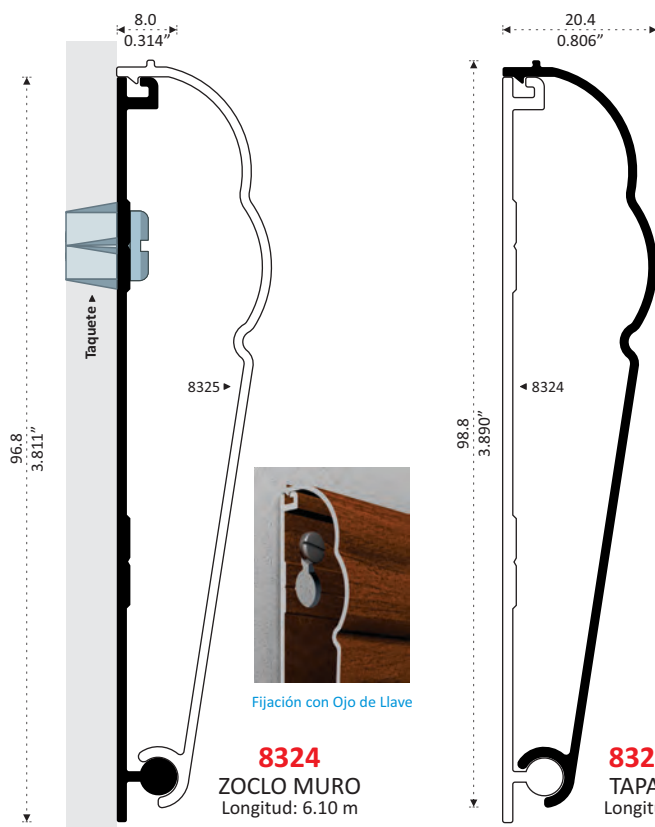

8324
ZOCLO MURO
Longitud: 6.10 m

8325 PATENTE
TAPA ZOCLO
Longitud: 6.10 m

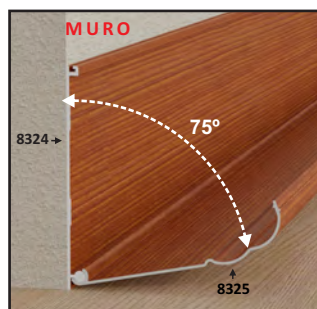

MAYOR ÁNGULO DE APERTURA



SARDINELES

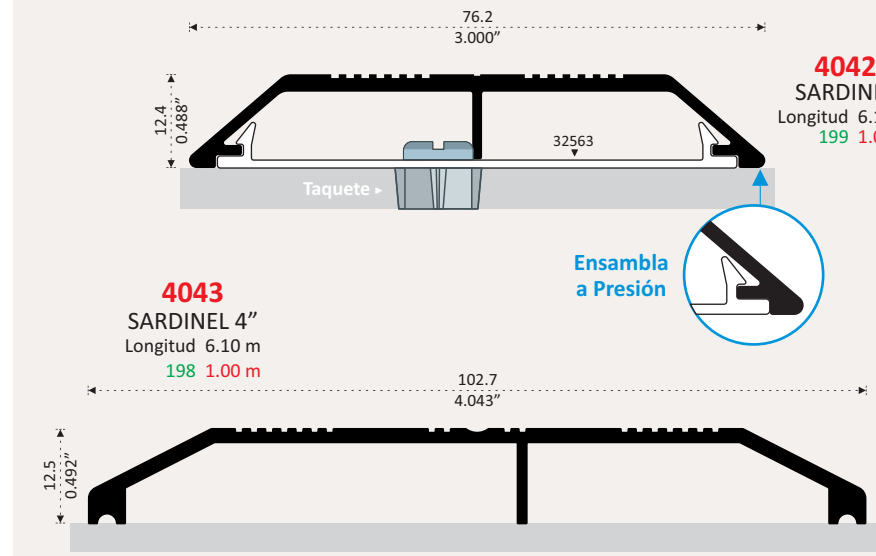

4042
SARDINEL
Longitud 6.10 m
199 1.00 m

4043
SARDINEL 4"
Longitud 6.10 m
198 1.00 m

REGLA DE CORTE



5019
REGLA DE CORTE
Longitud 5.80 m

CORREDIZO

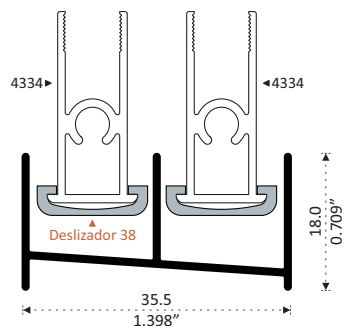
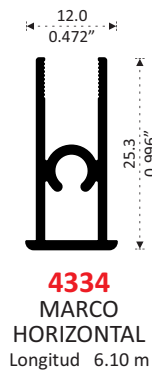
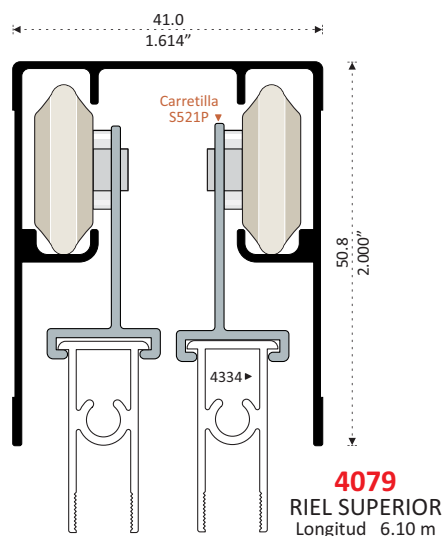

4332
GUÍA INFERIOR
Longitud 6.10 m

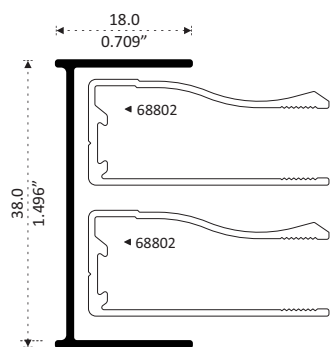

4331
JAMBA
Longitud 5.50 m
4331-B 3.77 m
4331-C 3.66 m

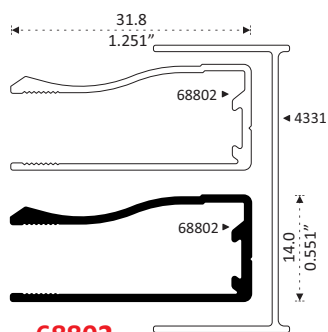

68802
MARCO
Longitud 6.10 m
68802-C 3.66 m



4112
JALADERA TROMPA DE ELEFANTE
Longitud 6.10 m

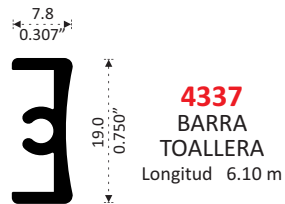

4337
BARRA TOALLERA
Longitud 6.10 m

Cancel de Baño sin Vinil

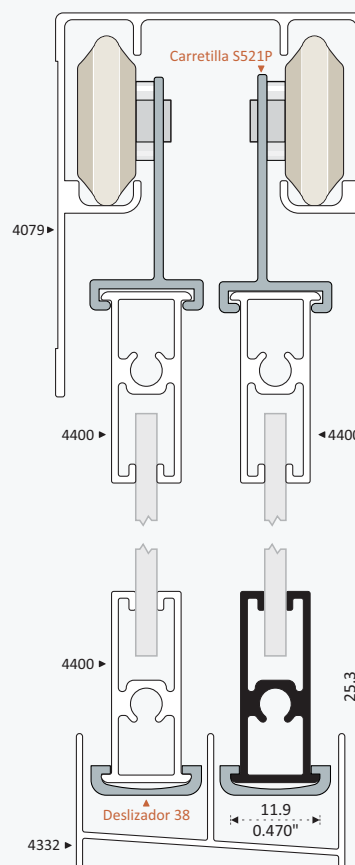

4400
MARCO HORIZONTAL
Longitud 6.10 m
4400-C 3.05 m



8801
MARCO
Longitud 3.66 m



8800
MARCO
Longitud 3.66 m



TOALLERO



2504
TUBO RECTANGULAR DOS VISTAS
Longitud 6.10 m
TDV 1 m

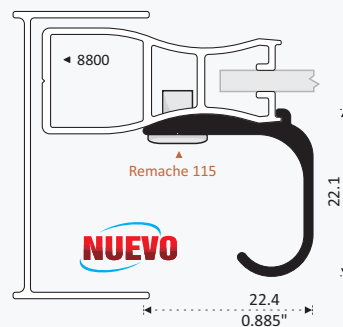

4200
JALADERA TROMPA DE ELEFANTE
Longitud 3.05 m
JT42 10 cm

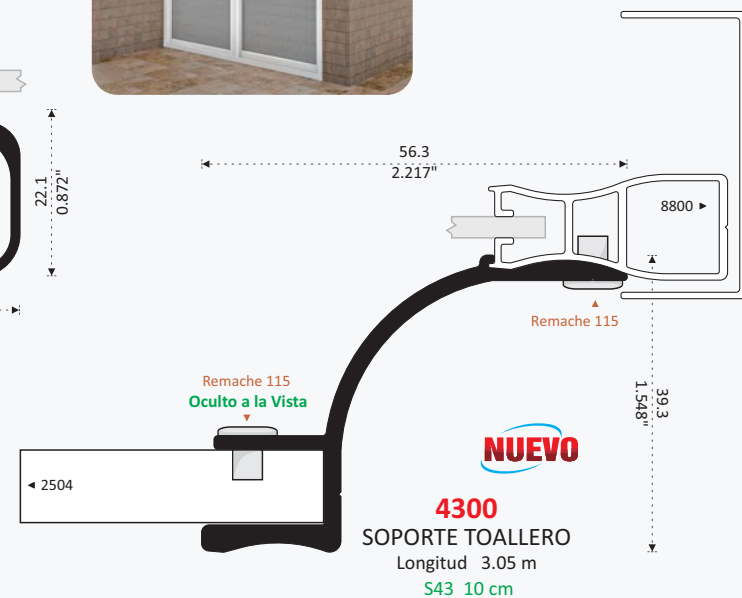

4300
SOPORTE TOALLERO
Longitud 3.05 m
S43 10 cm

MAYOR VISTA

9947
RIEL SUPERIOR
Longitud 6.10 m

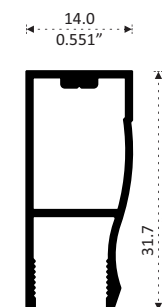
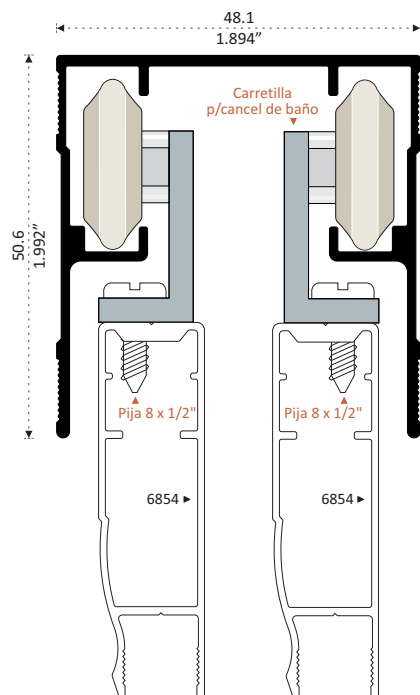

11036
MARCO
Longitud 3.77 m

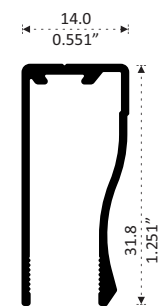

68802
MARCO
Longitud 6.10 m
68802-C 3.66 m

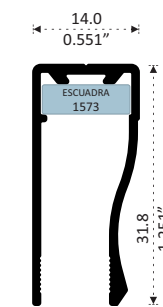

8802
MARCO 1 1/4"
SENCILLO
Longitud 6.10 m
8802-C 3.66 m

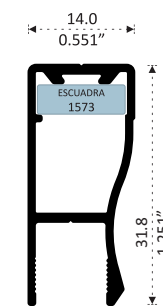

611035
MARCO 1 1/4"
REFORZADO
Longitud 6.10 m
611035-C 3.66 m



11035
MARCO 1 1/4"
REFORZADO
Longitud 6.10 m



9756
MARCO 1 3/4"
SEMI-LUJO
Longitud 6.10 m

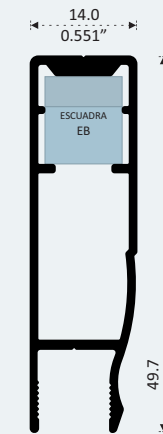

6854
MARCO
Longitud 6.10 m

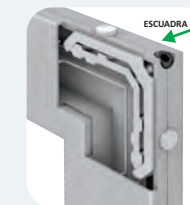

Marco Armado con
Escuadra de Botón **EB**
AJUSTA Y CIERRA EL CORTE

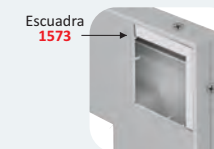

Marco Armado con
Escuadra Tradicional **1573**

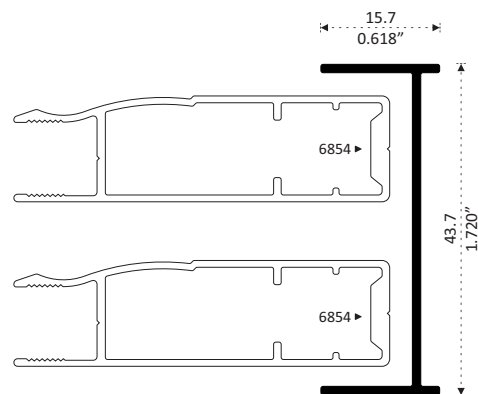

10197
JAMBA
Longitud 5.50 m

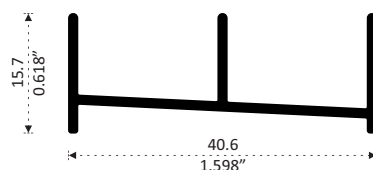

10198
GUÍA INFERIOR
Longitud 6.10 m

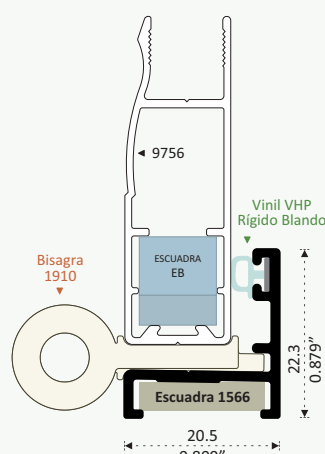

4127
BATIENTE ECONÓMICO
Longitud 6.10 m

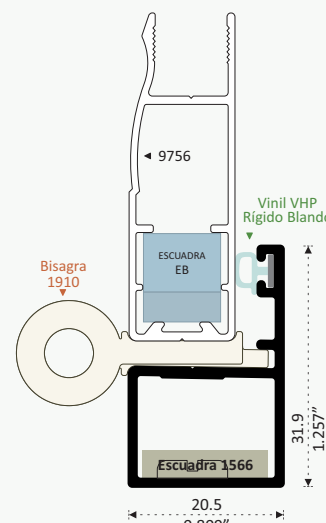

7102
BATIENTE COMERCIAL
Longitud 6.10 m

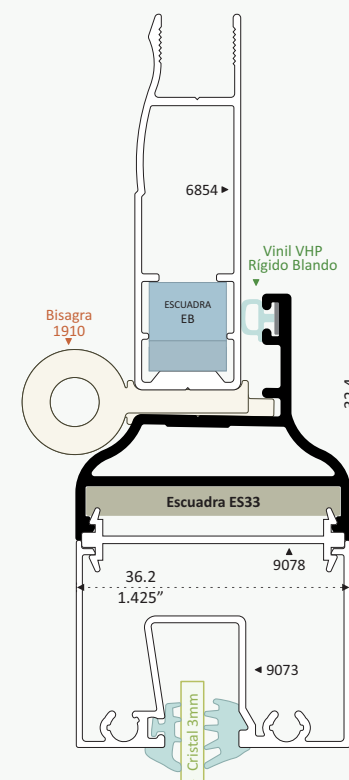

9069
BATIENTE CURVO
Longitud 6.10 m



Colocación de
Bisagra 1910

BATIENTES

Perfiles con Inclinación en la Base de Fijación de la Bisagra Mejorando el Cierre

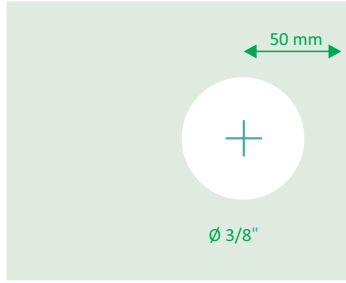

PERFORACIÓN DE JALADERA

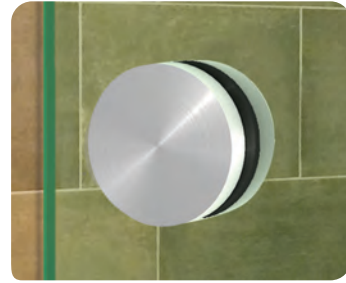

JALADERA



ESCUADRA

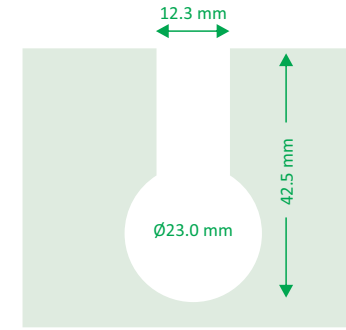

RESAQUE PARA CARRETILLA



CARRETILLA

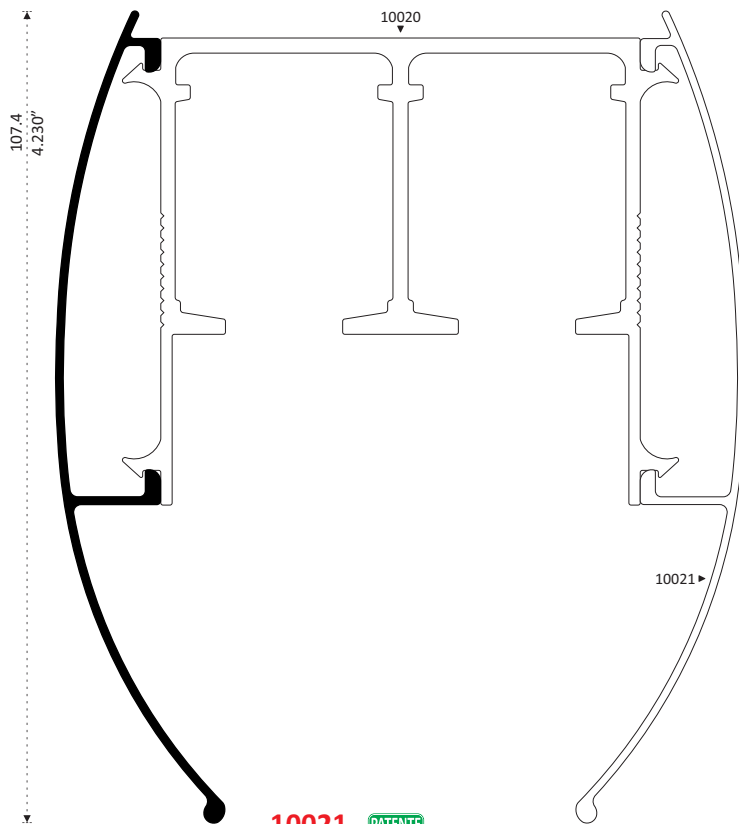

10021 PATENTE
TAPA CURVA
Longitud 6.10 m

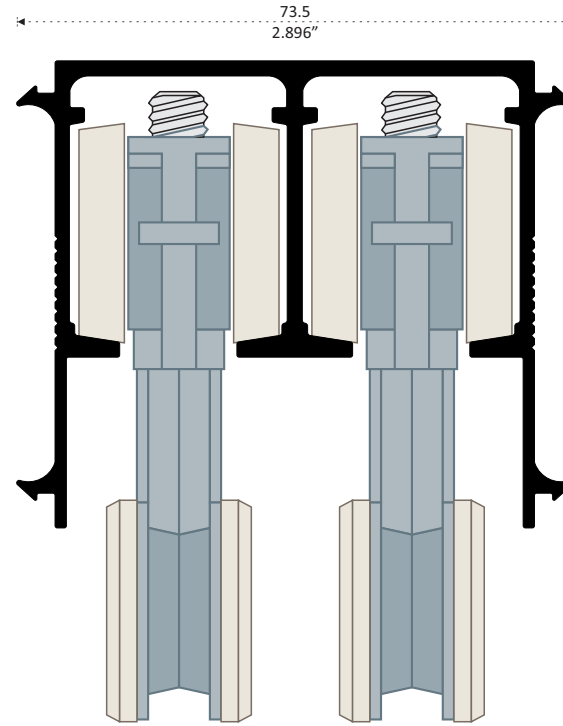

10020 PATENTE
RIEL SUPERIOR
Longitud 6.10 m

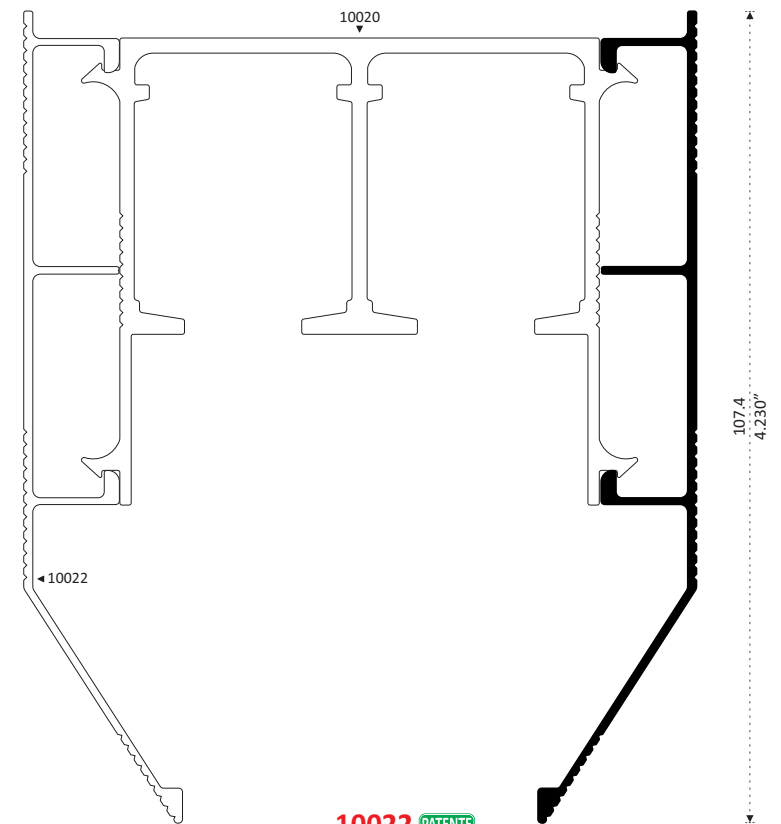

10022 PATENTE
TAPA MINIMALISTA
Longitud 6.10 m

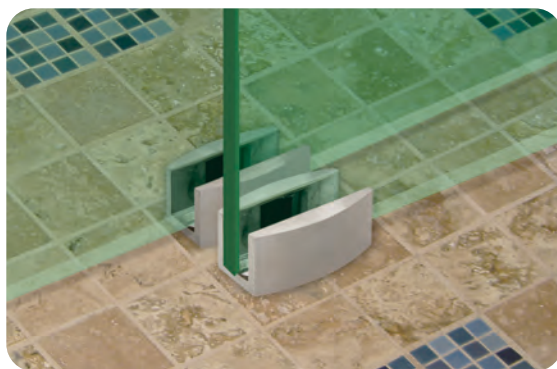

GUIA INFERIOR

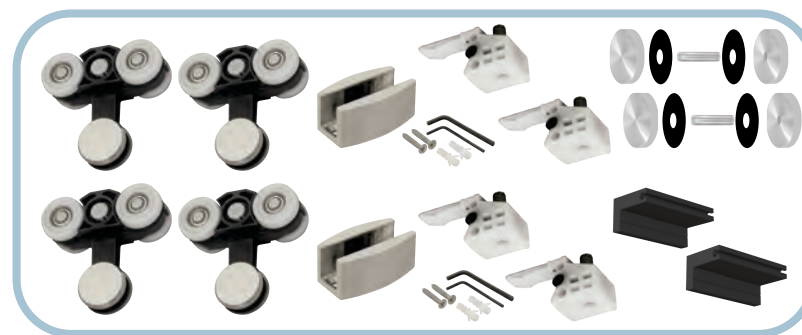

SE REQUIEREN 2 JUEGOS POR CANCEL

JCT6 Juego para Cristal de 6 mm
JCT9 Juego para Cristal de 9 mm

JCT6R Juego para Cristal de 6 mm Resistencia Salina
JCT9R Juego para Cristal de 9 mm Resistencia Salina

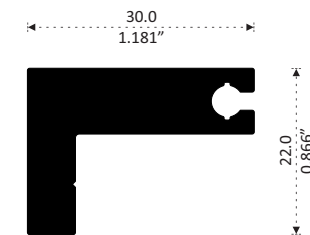

10201
ESCUADRA CON VENA
Longitud 3.05 m

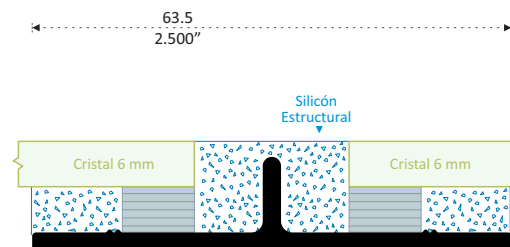
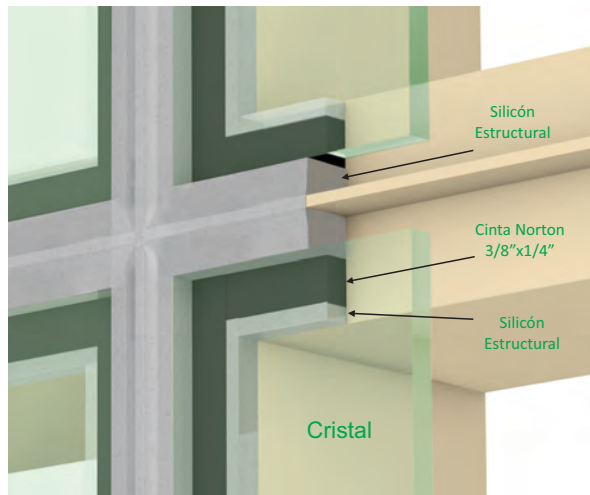

Cinta Norton
3/8"x1/4"

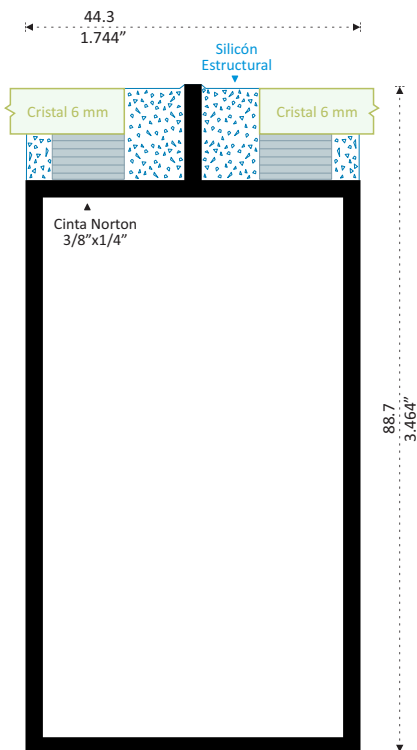

611003
BÁSICO TUBULAR
INTEGRAL 3" X 1 3/4"
Longitud 6.10 m

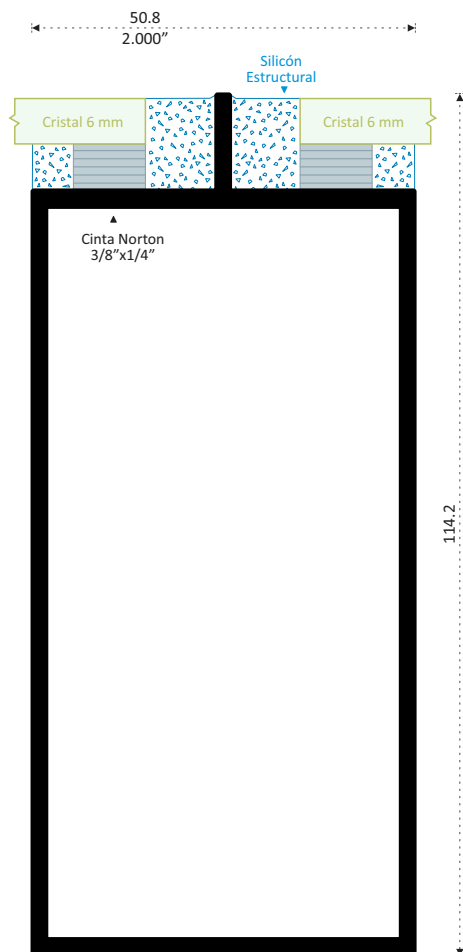

11004
BÁSICO TUBULAR
INTEGRAL 4" X 2"
Longitud 6.10 m

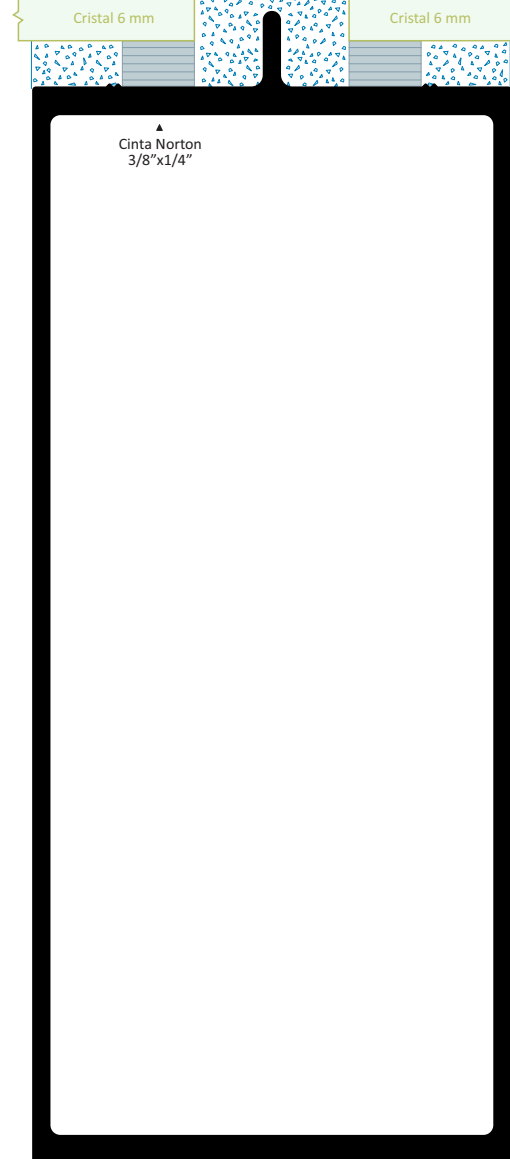

14739
BÁSICO TUBULAR
INTEGRAL 6" X 2 1/2"
Longitud 6.10 m

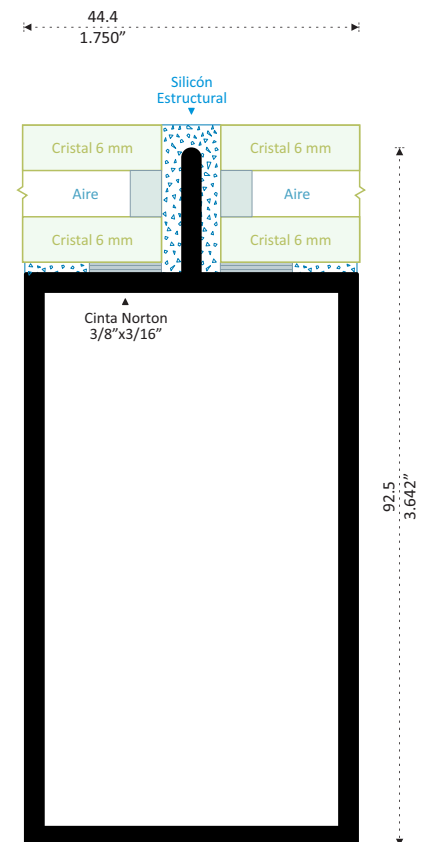

11003
BÁSICO TUBULAR
INTEGRAL 3" X 1 3/4"
Longitud 6.10 m

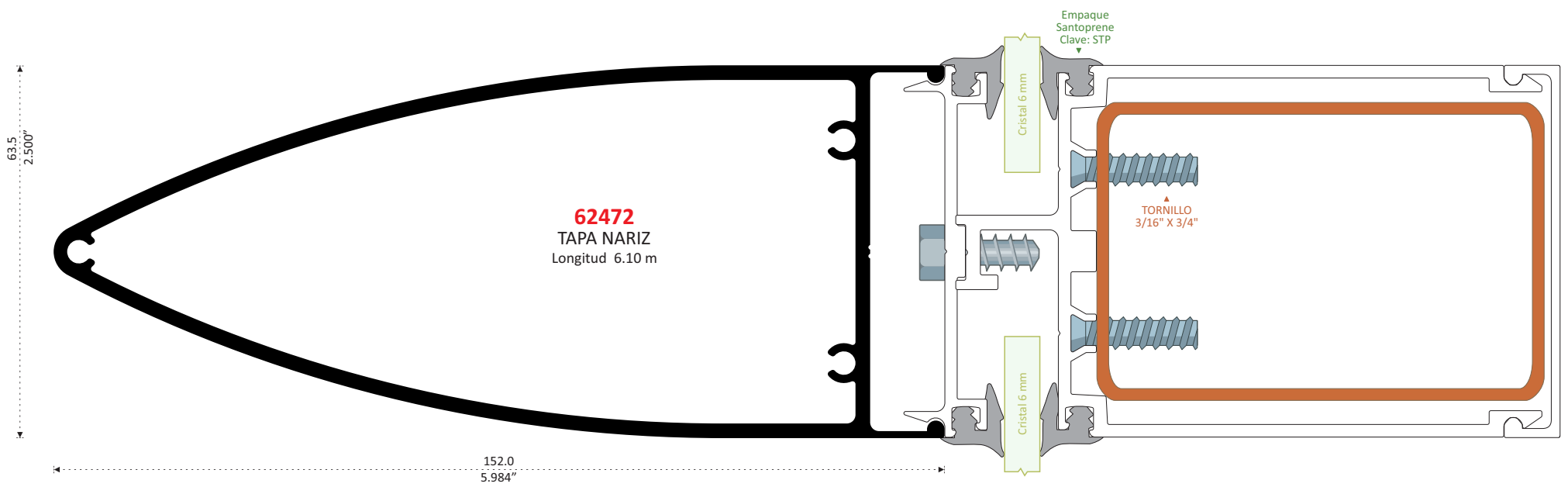
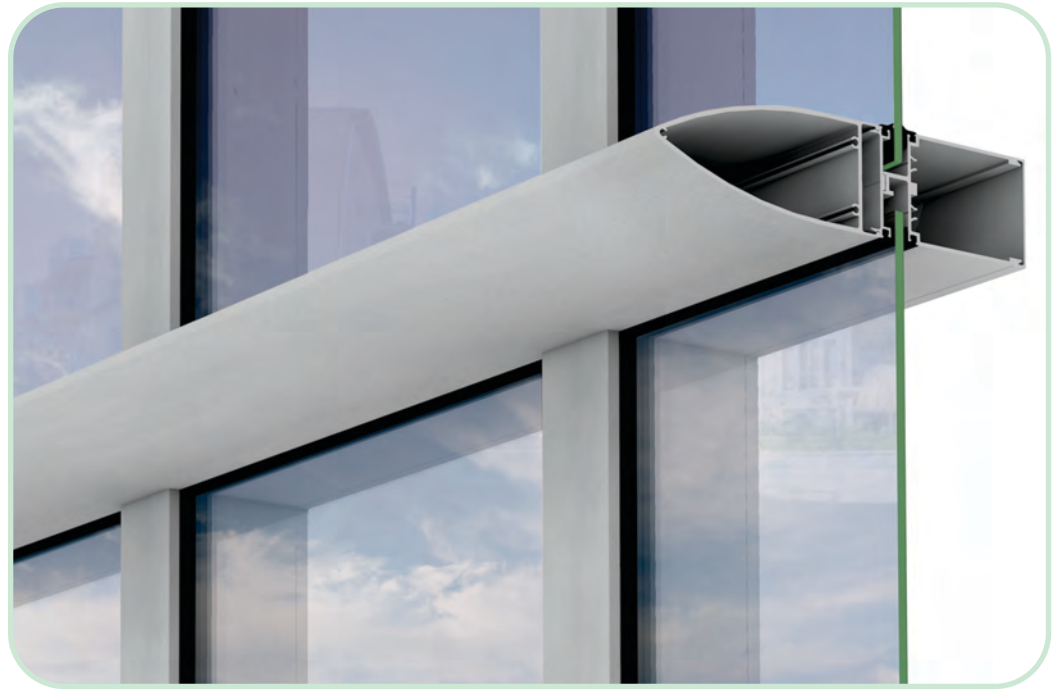
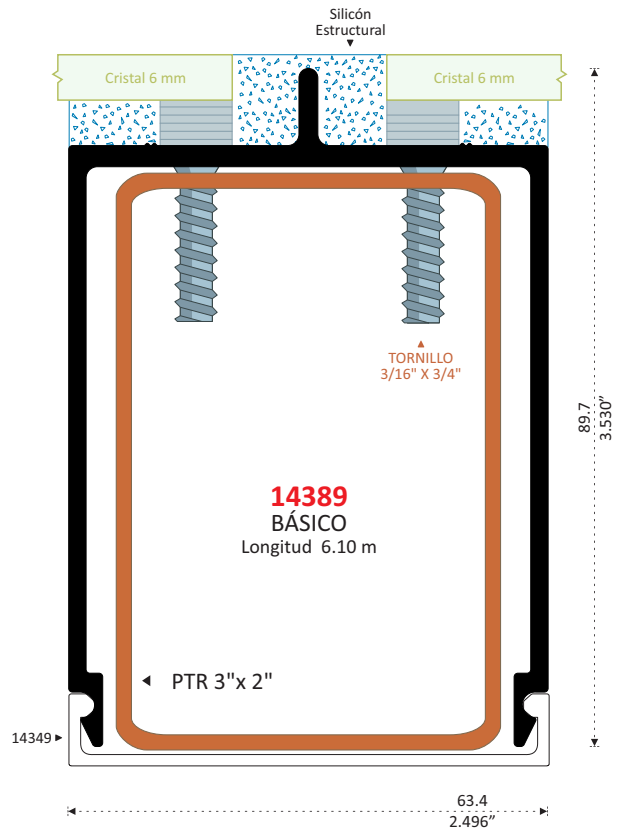

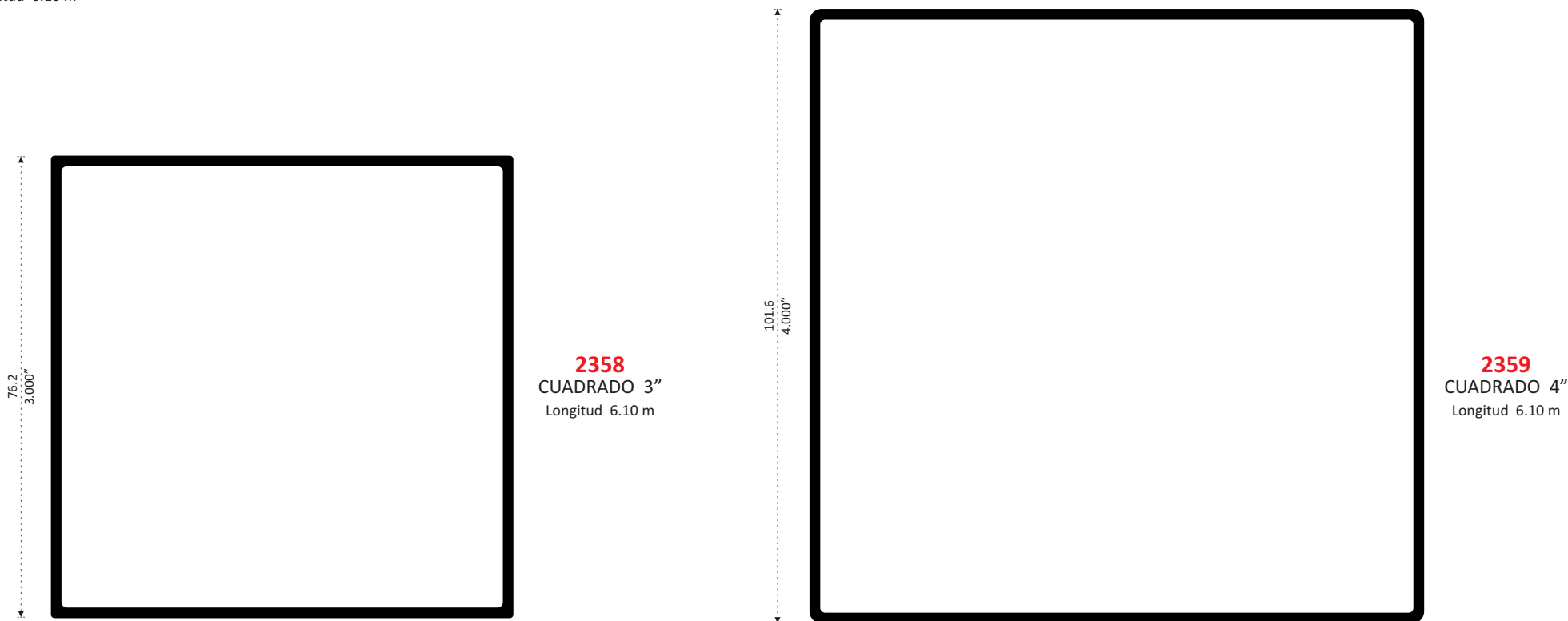
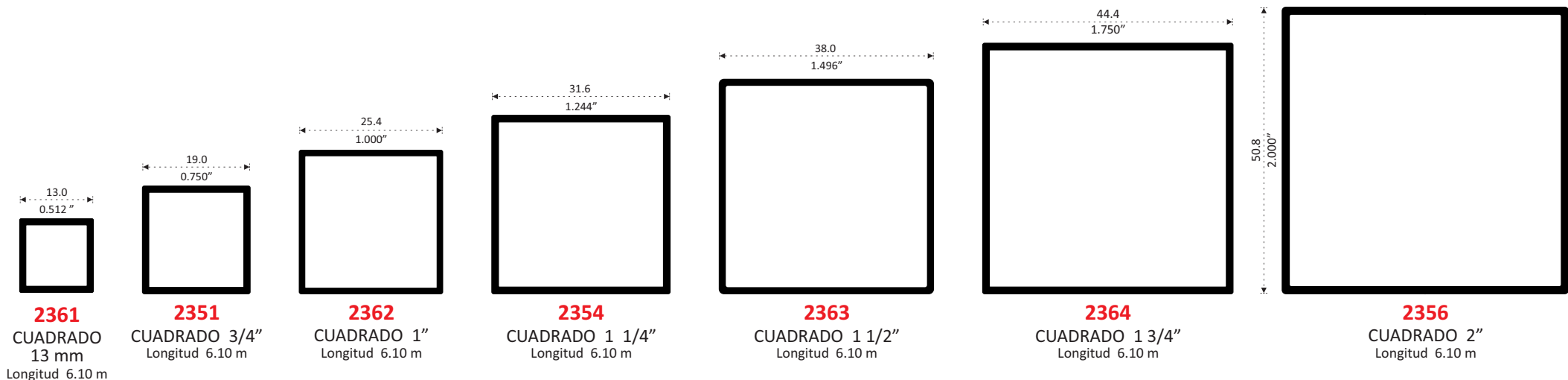

LIGHT

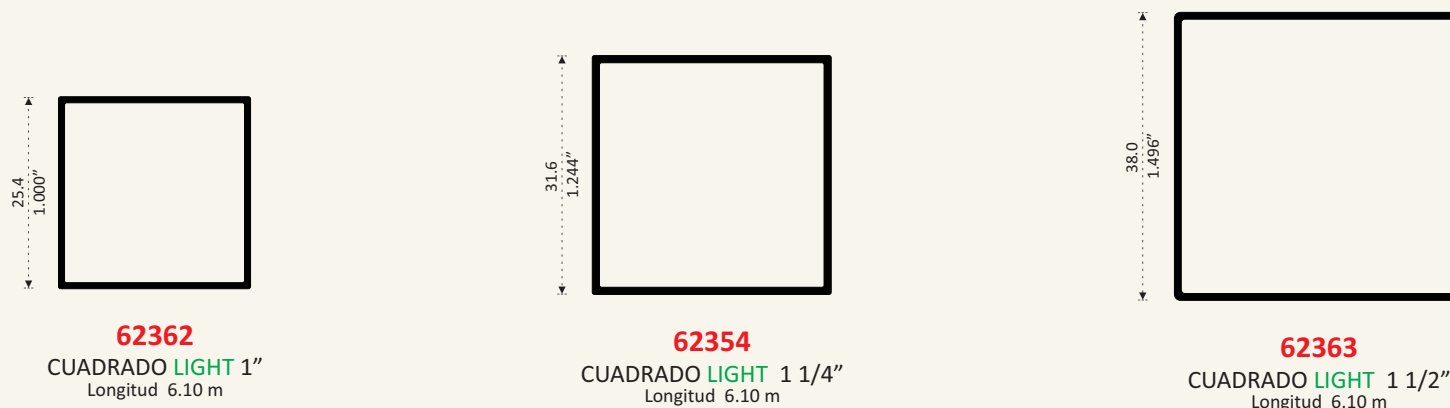

**ROMPE VISTAS
CUADRICULADAS**

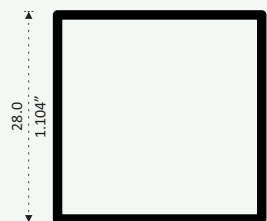

12362
CUADRADO 28 mm
Longitud 6.10 m



ENSAMBLE CON 2362

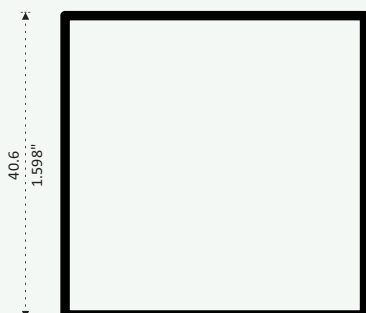
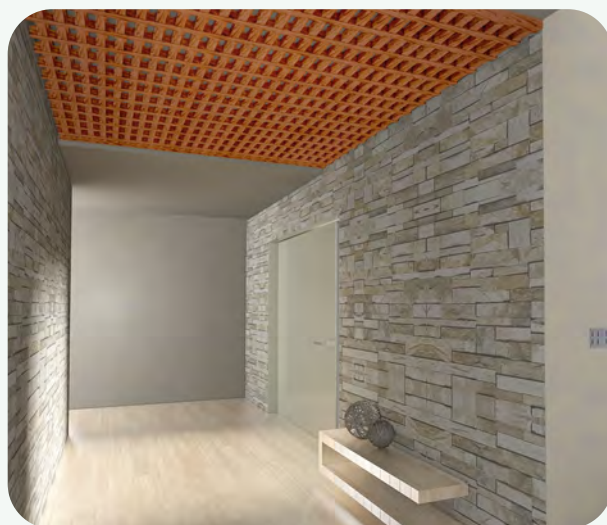

12363
CUADRADO 40.6 mm
Longitud 6.10 m



ENSAMBLE CON 2363



2105
REDONDO DE 1/2"
Longitud 6.10 m

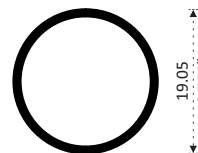

2108
REDONDO DE 3/4"
Longitud 6.10 m

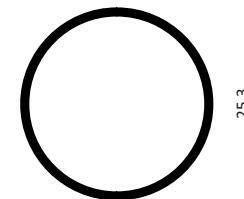

2111
REDONDO DE 1"
Longitud 6.10 m

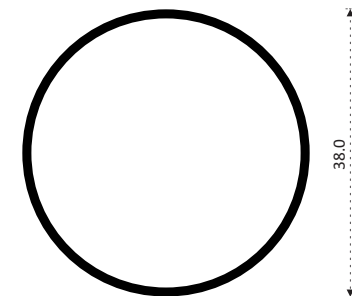

22082
REDONDO 1 1/2"
Longitud 6.10 m

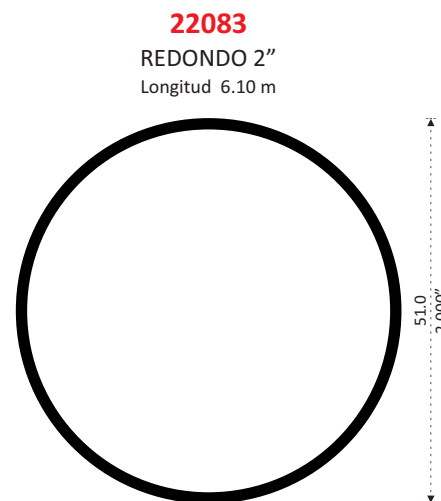

22083
REDONDO 2"
Longitud 6.10 m

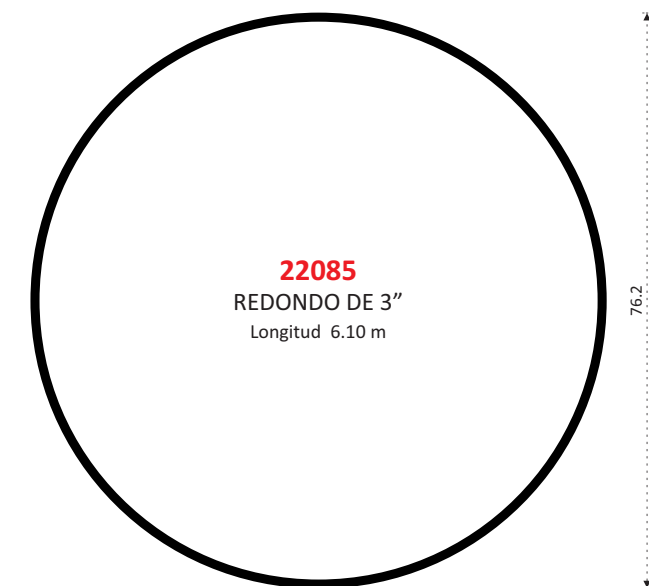

22085
REDONDO DE 3"
Longitud 6.10 m



Tapa Tubo
Redondo 2"

3135



Tapa Tubo
Redondo 3"

3136



19.05
0.750"

2502
RECTANGULAR
3/4" x 3/8"
Longitud 6.10 m

38.1
1.500"

2503
RECTANGULAR
38.1 x 8.6
Longitud 6.10 m

38.0
1.476"

2515
RECTANGULAR
1 1/2" x 3/4"
Longitud 6.10 m

50.8
2.000"

2521
RECTANGULAR 2" x 1"
Longitud 6.10 m

63.1
2.484"

2513
RECTANGULAR 2 1/2" x 1 1/4"
Longitud 6.10 m

70.6
2.779"

20080
TUBO RECTANGULAR
Longitud 6.10 m

76.2
3.000"

2516
RECTANGULAR 3" x 1"
Longitud 6.10 m

76.2
3.000"

2522
RECTANGULAR 3" x 1 3/4"
Longitud 6.10 m

101.0
4.000"

2520
RECTANGULAR 4" x 1 3/4"
Longitud 6.10 m

140.0
5.512"

2532
RECTANGULAR 140 x 35
Longitud 6.10 m

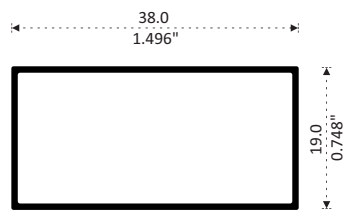

62515
RECTANGULAR
1 1/2" x 3/4"
Longitud 6.10 m

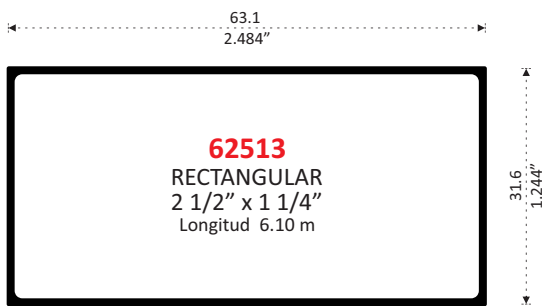

62513
RECTANGULAR
2 1/2" x 1 1/4"
Longitud 6.10 m



NUEVO
62522
RECTANGULAR 3" x 1 3/4"
Longitud 6.10 m



NUEVO
1214
TAPA
Longitud 6.10 m



TL3

Para Perfiles 2522 - 62522
Cortado del Perfil 1214

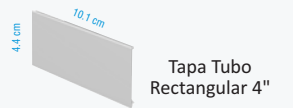

TL4

Para Perfiles 2520 - 62520
Cortado del Perfil 1214



TT2
Tapa Tubo
Rectangular 2"
Para Perfil 62521
Cortado del Perfil 1215

TT3
Tapa Tubo
Rectangular 3"
Para Perfil 62516
Cortado del Perfil 1215



Perfil Clave
1215

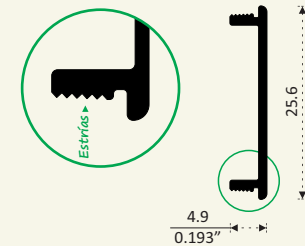

1215
TAPA
Longitud 6.10 m

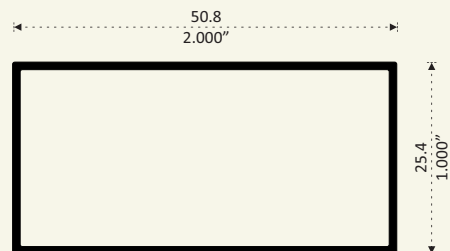

62521
RECTANGULAR 2" x 1"
Longitud 6.10 m

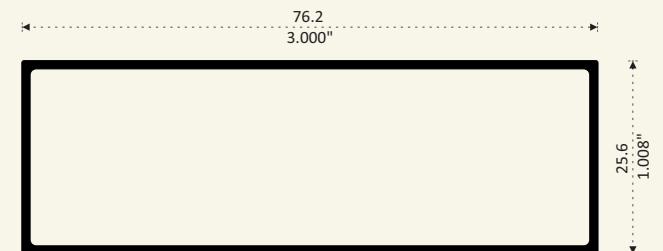

62516
RECTANGULAR 3" X 1"
Longitud 6.10 m

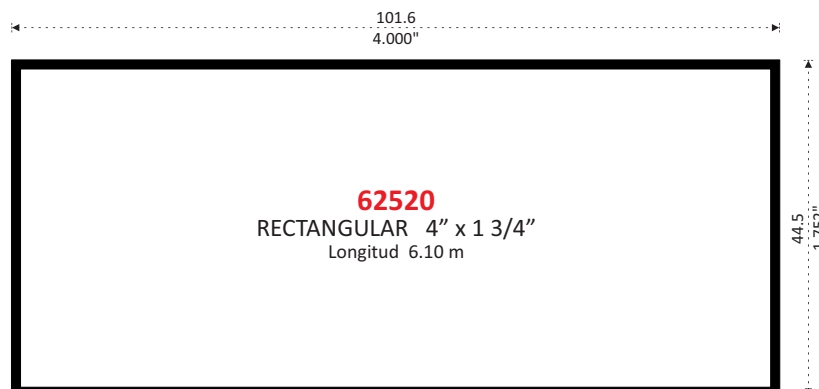

62520
RECTANGULAR 4" x 1 3/4"
Longitud 6.10 m

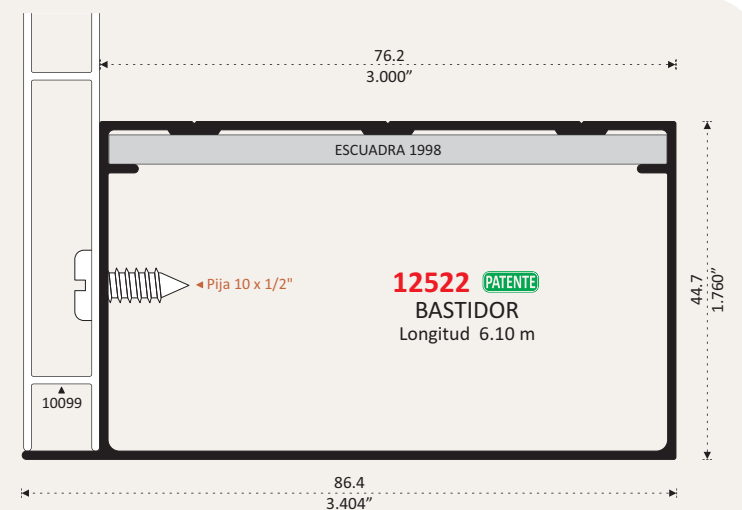

12522 **PATENTE**
BASTIDOR
Longitud 6.10 m



12523



50.0
1.968"

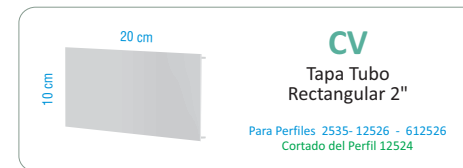

12524



100.0
3.937"

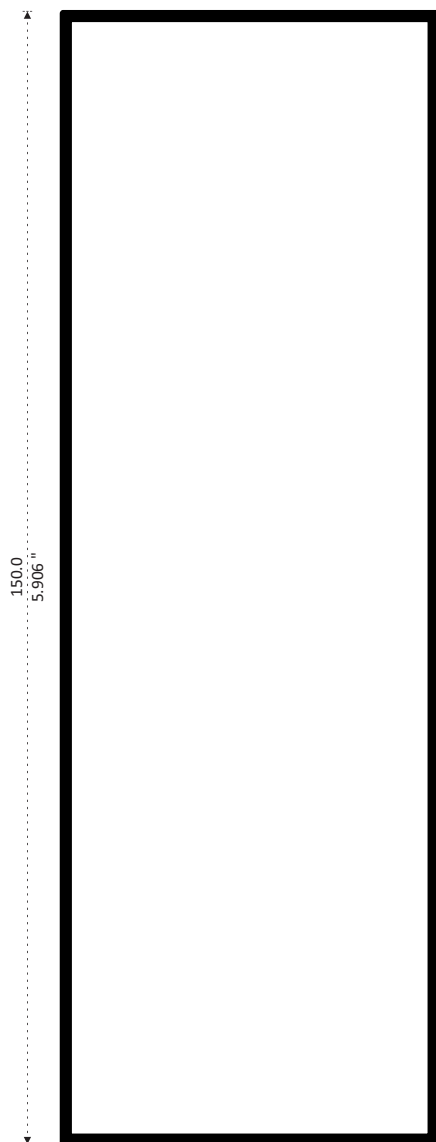

2533
RECTANGULAR
150 x 50
Longitud 6.10 m

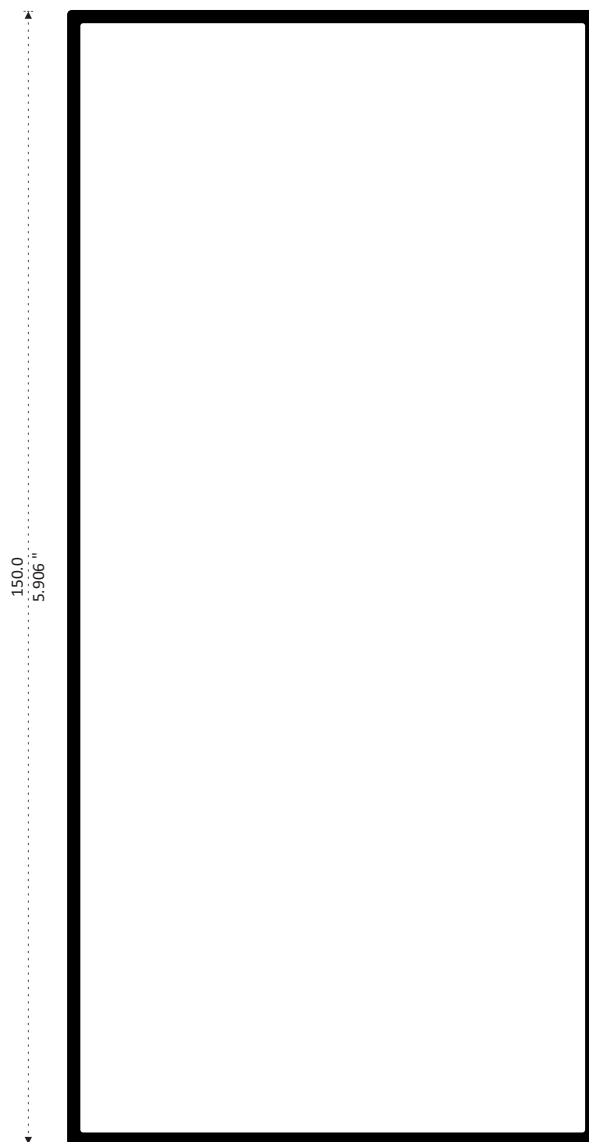

2534
VIGA RECTANGULAR
150 mm x 70 mm
Longitud 5.50 m

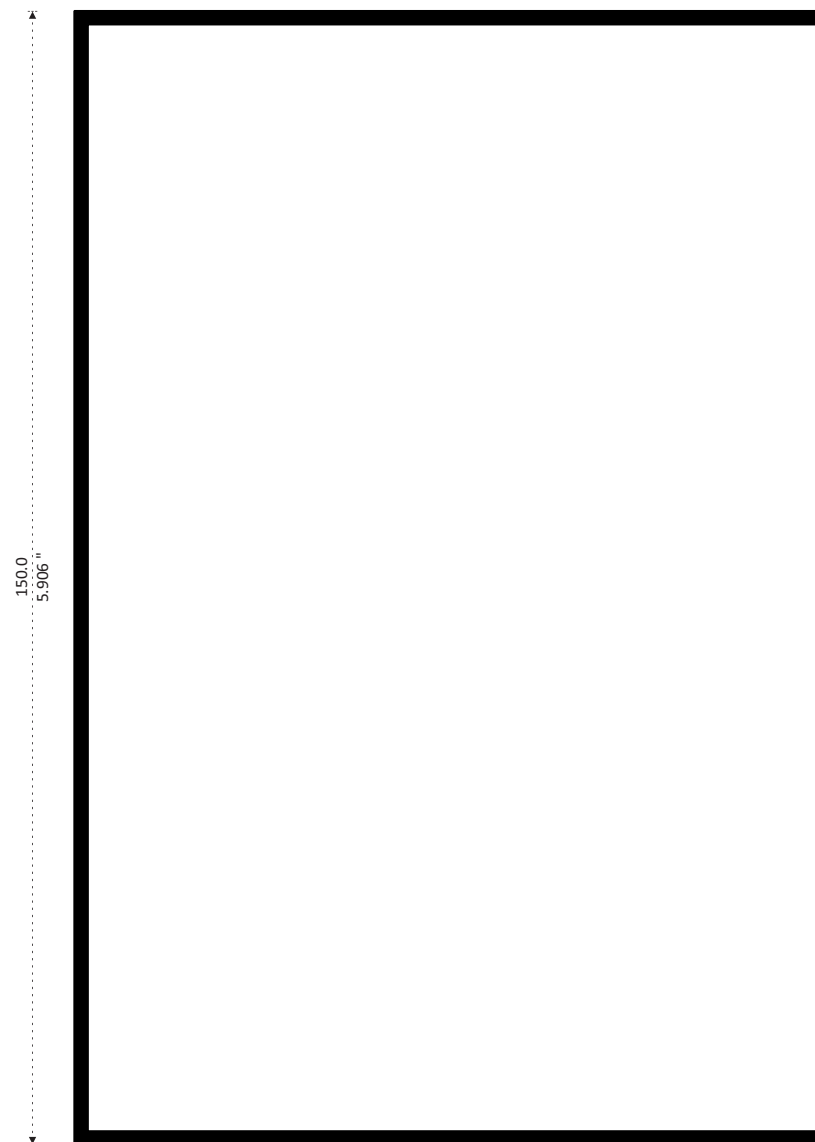

2535
VIGA RECTANGULAR
150 mm x 100 mm
Longitud 5.50 m

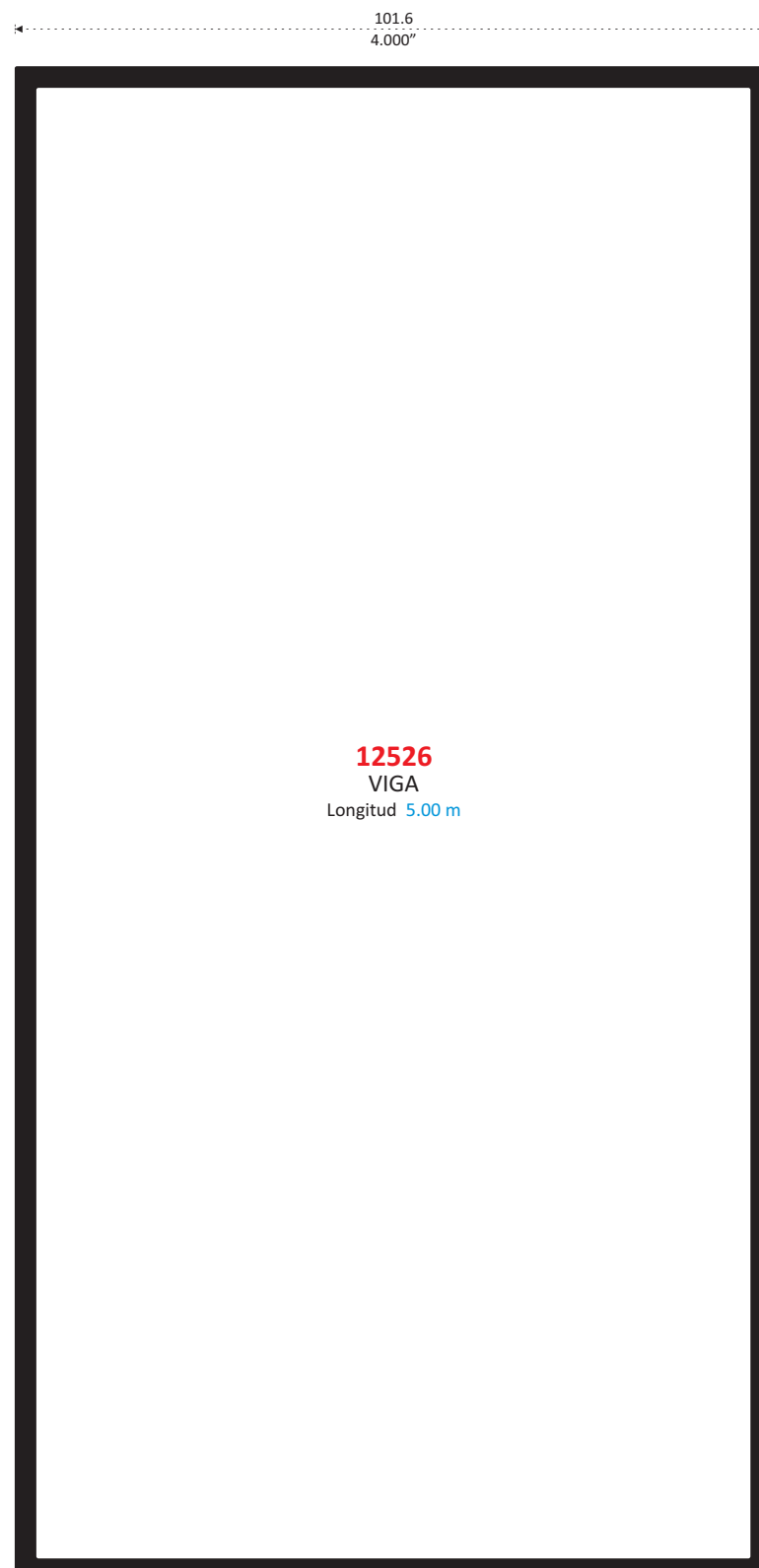
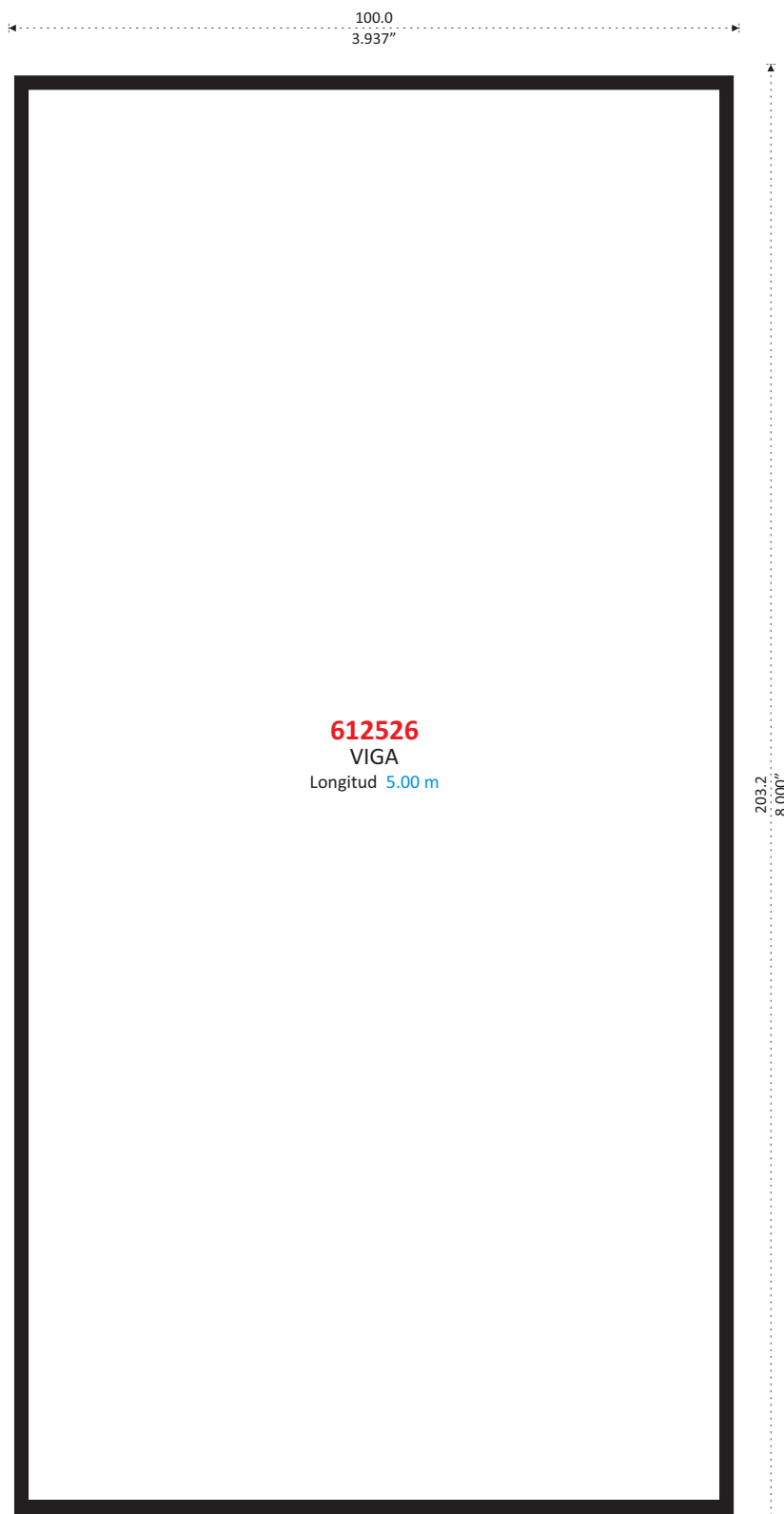
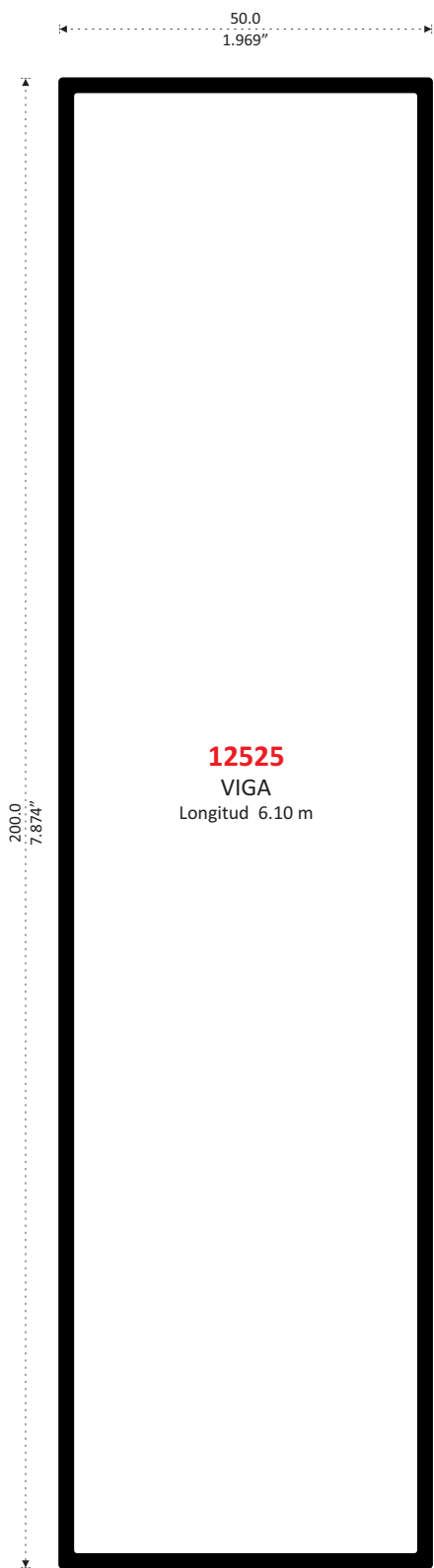
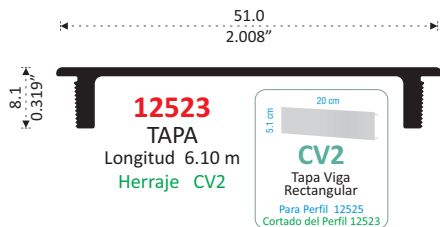

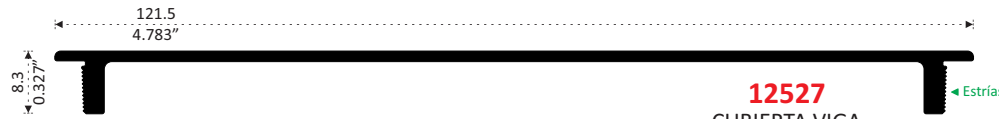

12527
CUBIERTA VIGA
Longitud 6.10 m
CLAVE HERRAJE: CVR

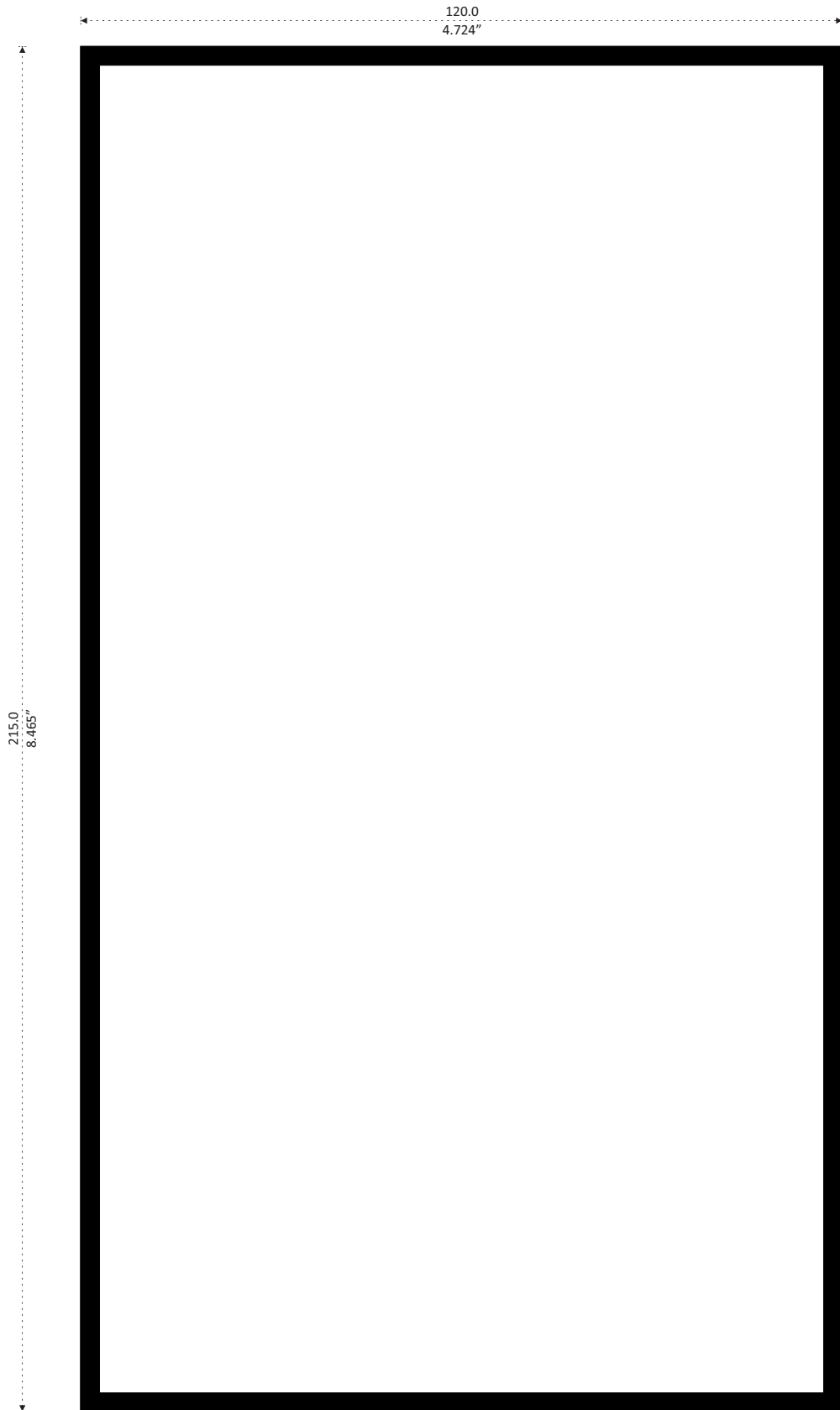

12529
VIGA
Longitud 5.50 m

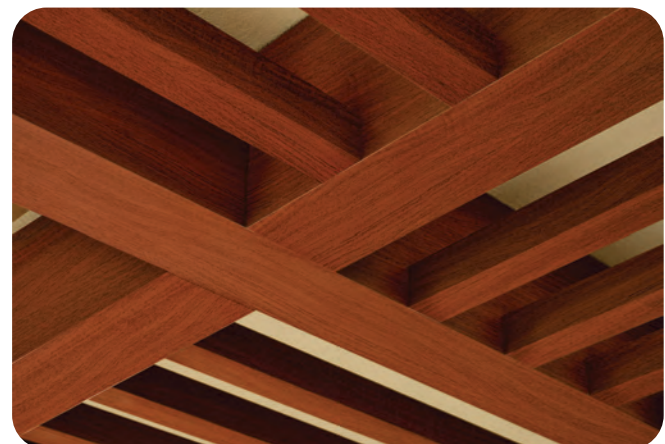

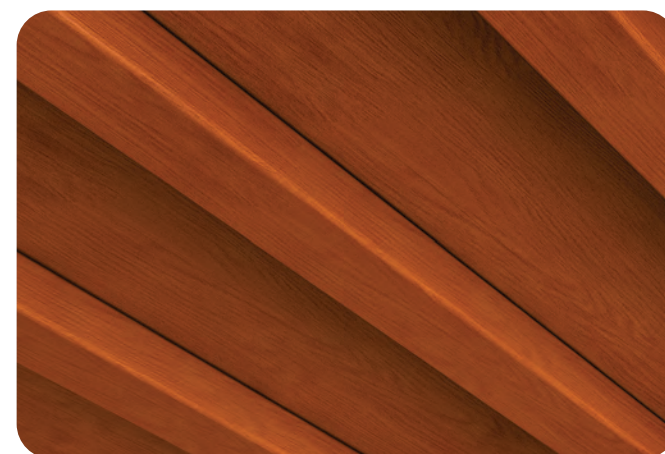
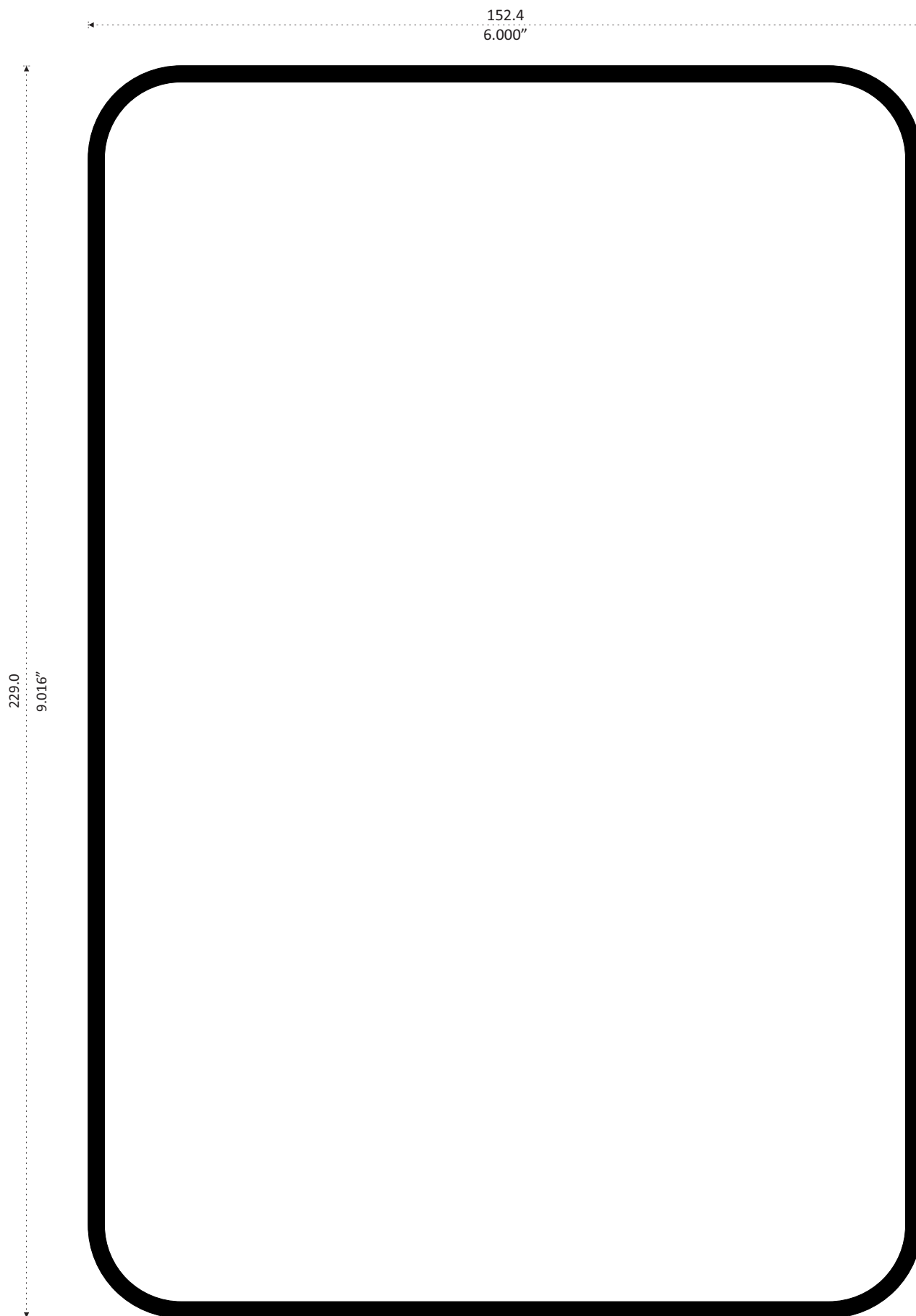

12528
VIGA COLONIAL
Longitud 5.50 m

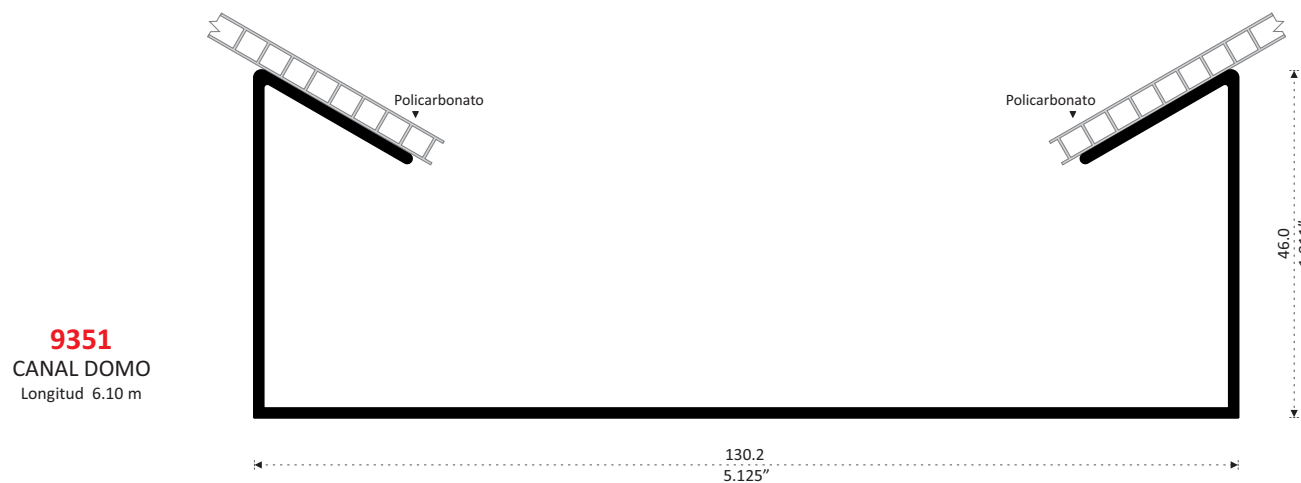
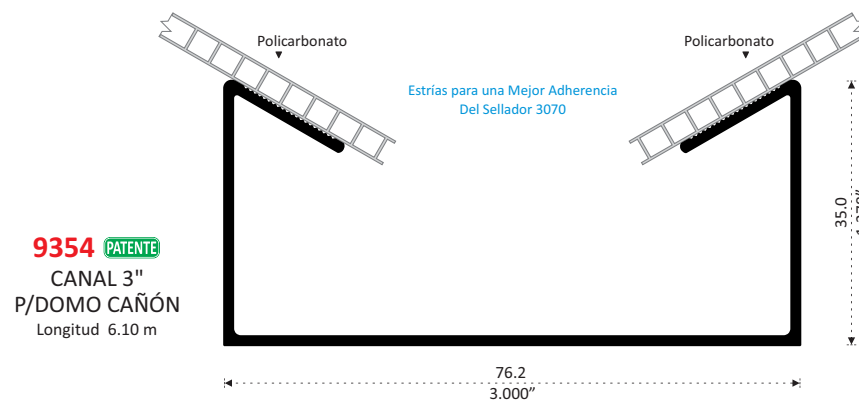
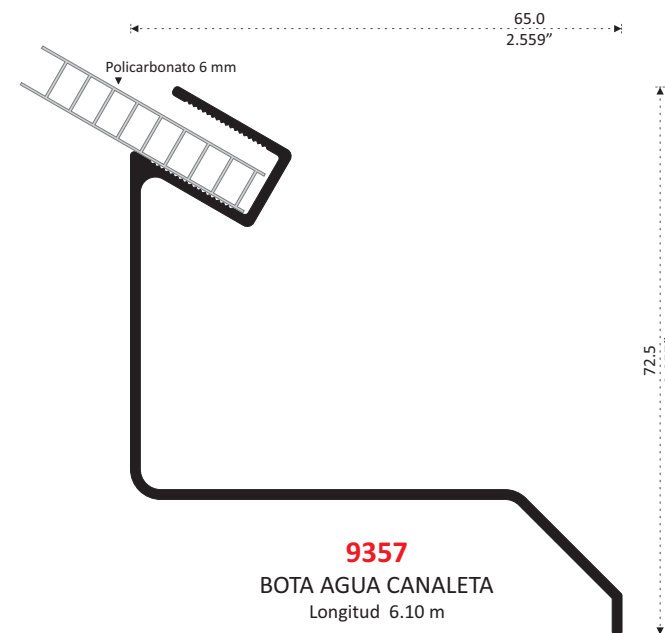
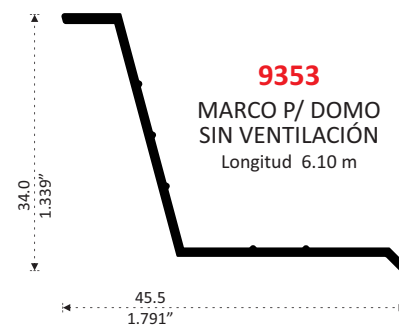
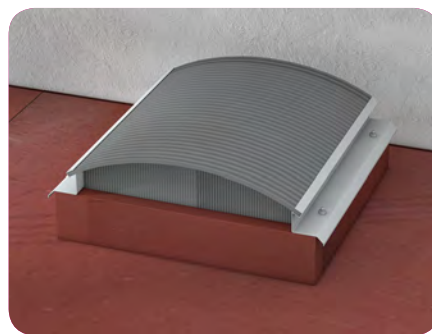
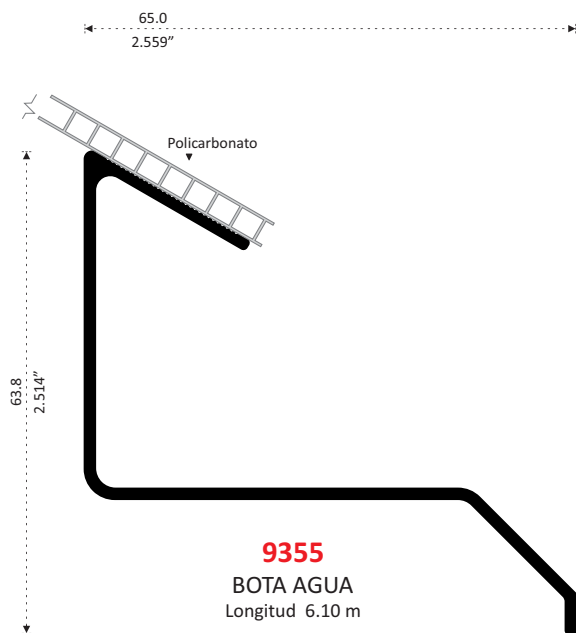

ÁNGULOS

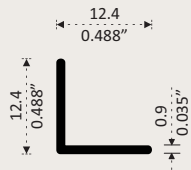

1301
Longitud 6.10 m

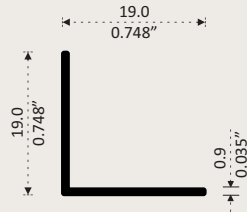

1303
Longitud 6.10 m

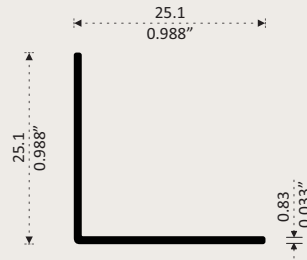

1304
Longitud 6.10 m

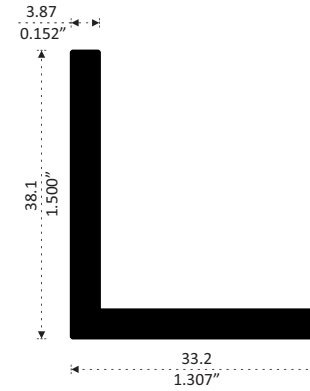

21311
Longitud 6.10 m
Ángulo para Escuadras Puerta Batiente Comercial

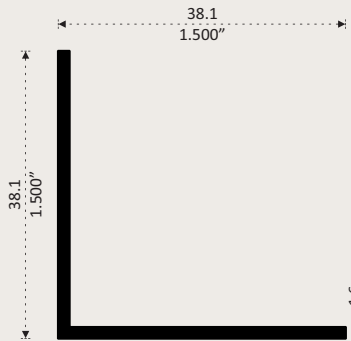

1420
Longitud 6.10 m

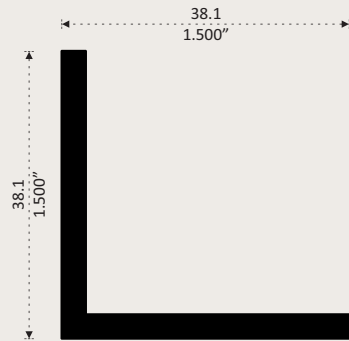

1314
Longitud 6.10 m

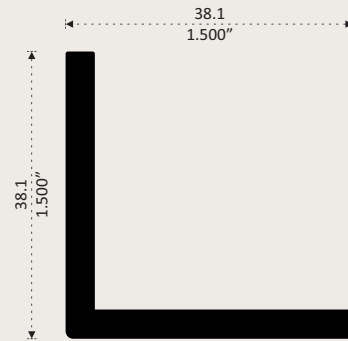

1311
Longitud 6.10 m

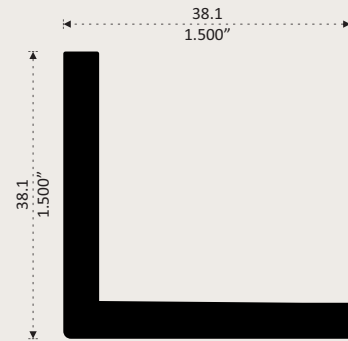

1315
Longitud 6.10 m

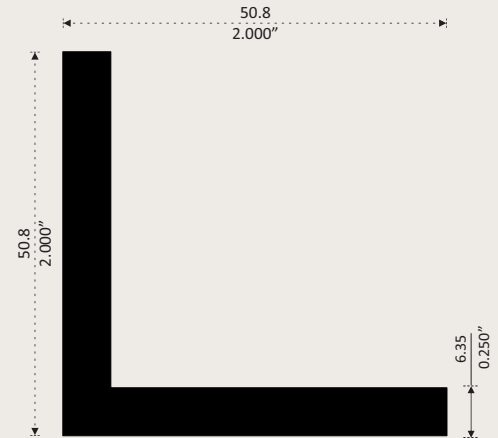

1318
Longitud 6.10 m

SOLERAS

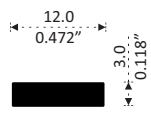

1203
Longitud 6.10 m

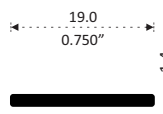

1201
Longitud 6.10 m

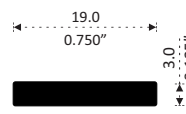

1204
Longitud 6.10 m

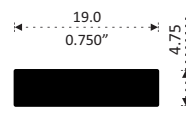

1211
Longitud 6.10 m

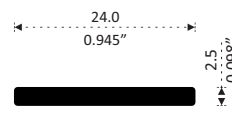

1205
Longitud 6.10 m

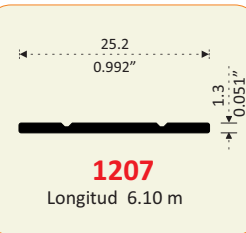

1207
Longitud 6.10 m

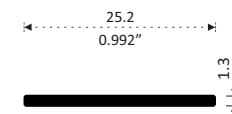

1202
Longitud 6.10 m

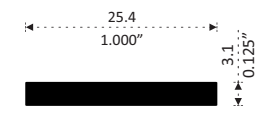

1228
Longitud 6.10 m

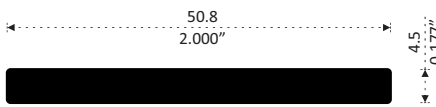

1216
Longitud 6.10 m

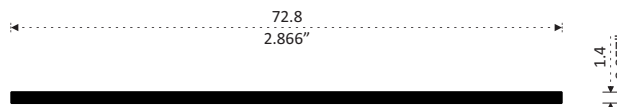

12580
Longitud 6.10 m

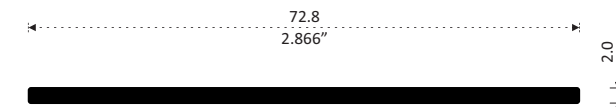

1258
Longitud 6.10 m

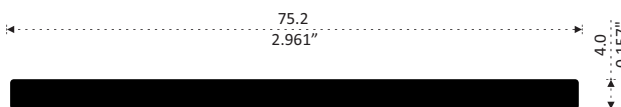

12590
Longitud 6.10 m

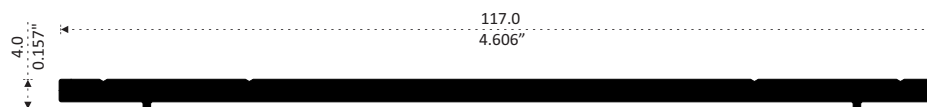

12591
TAPA BISAGRA Longitud 6.10 m

Clave Herraje:
3125 0.33 m

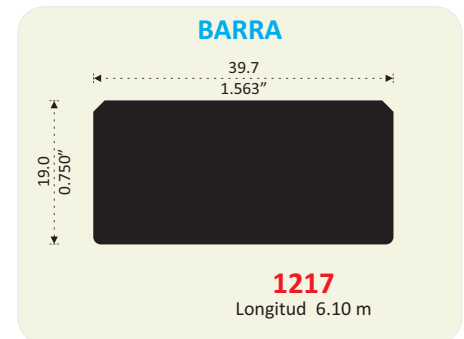

1217
Longitud 6.10 m

CRUCETA

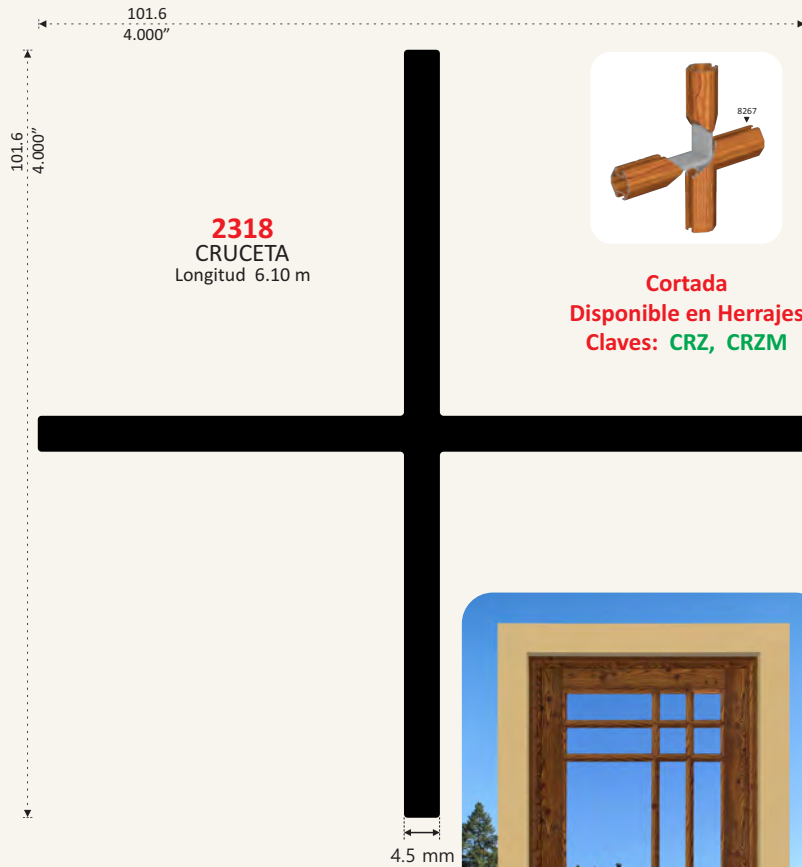

Cortada
Disponible en Herrajes
Claves: CRZ, CRZM



PORTA CRISTAL

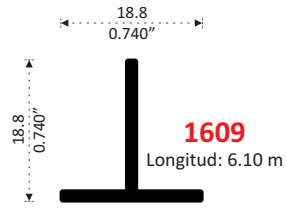
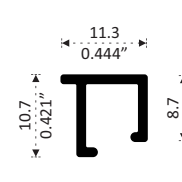
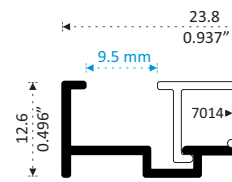

RIBETE DE PISO

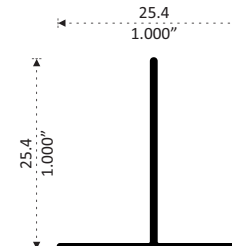
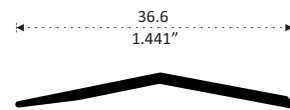

TEES

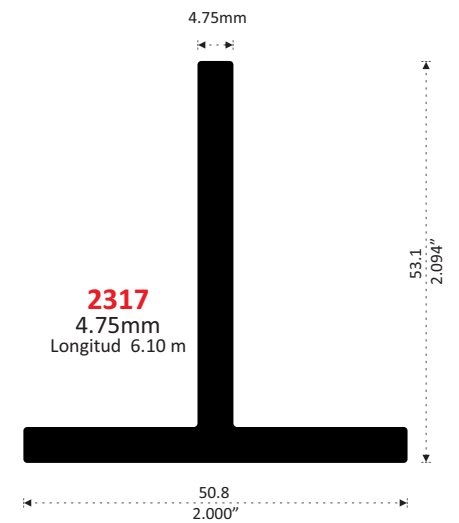

VAGUETAS

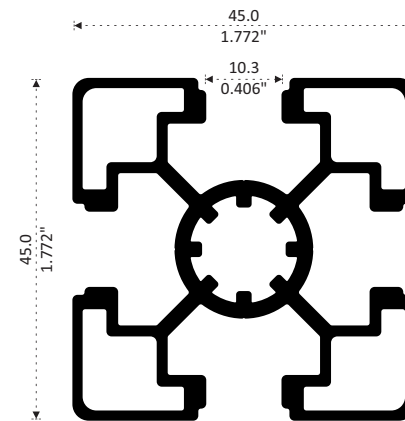
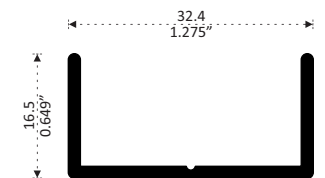
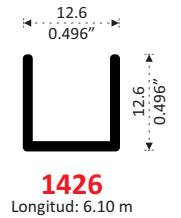
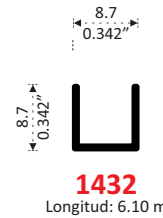

VITRINAS

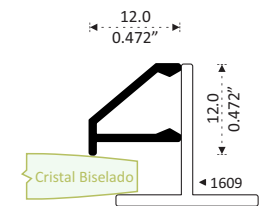
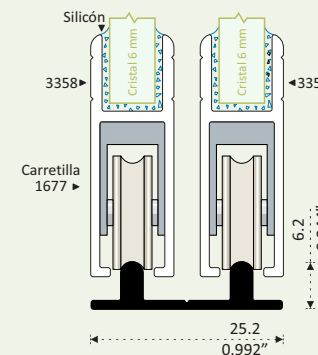
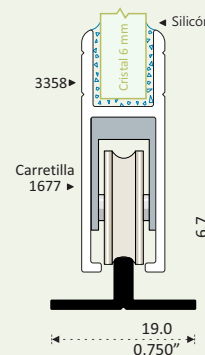
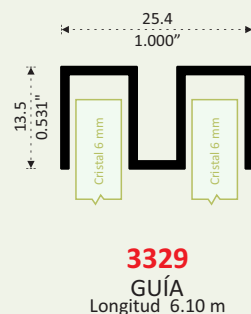
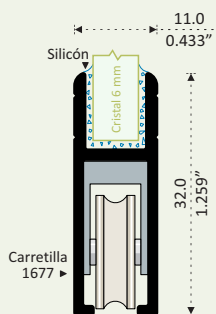

LÍNEA PIZARRÓN

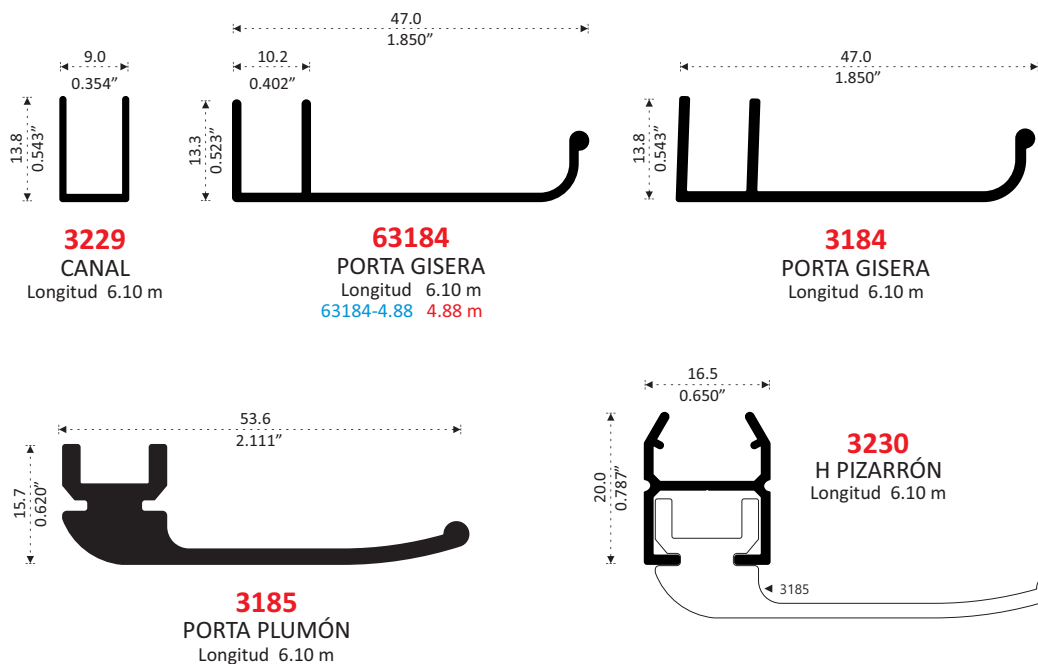

RIELES

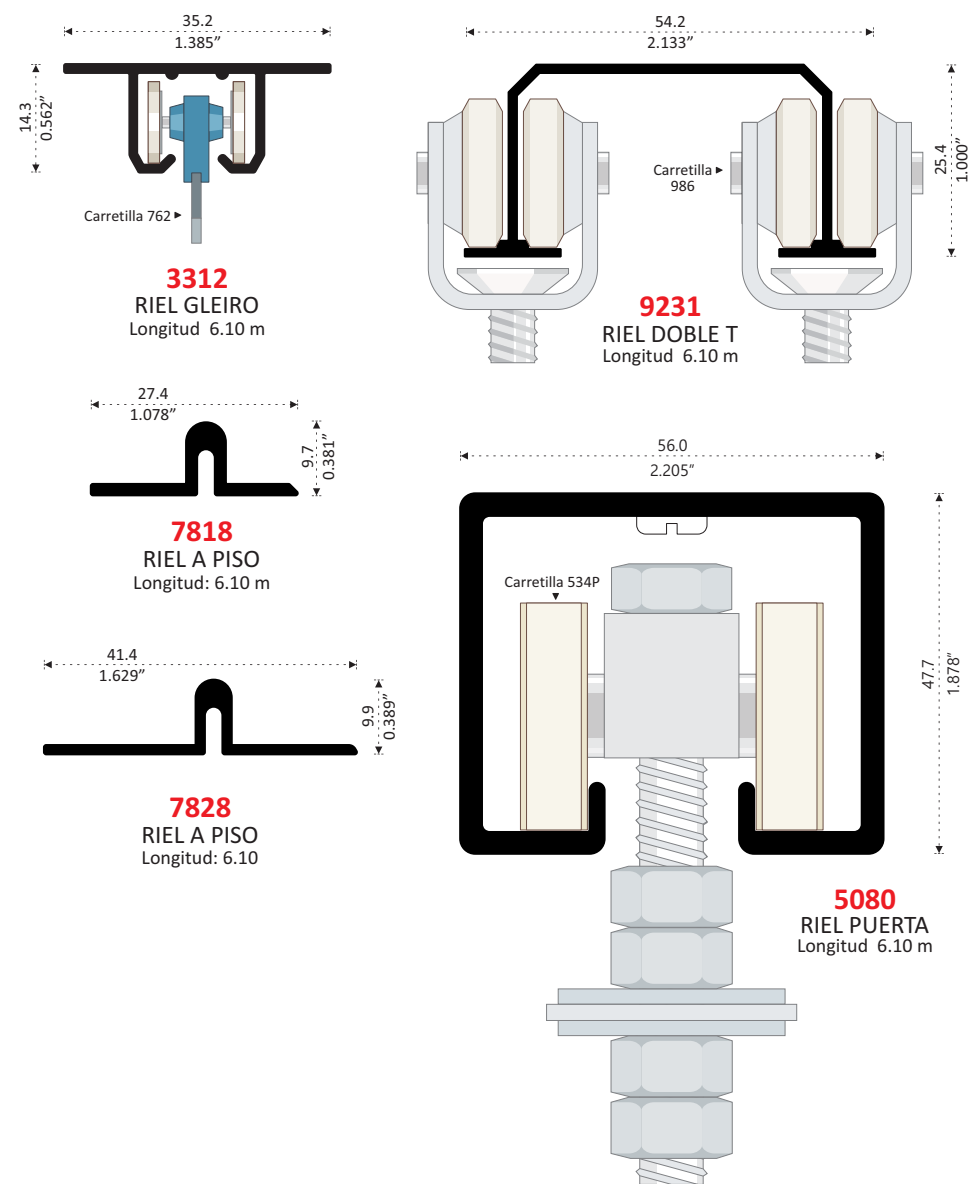

RIBETES DE MESA

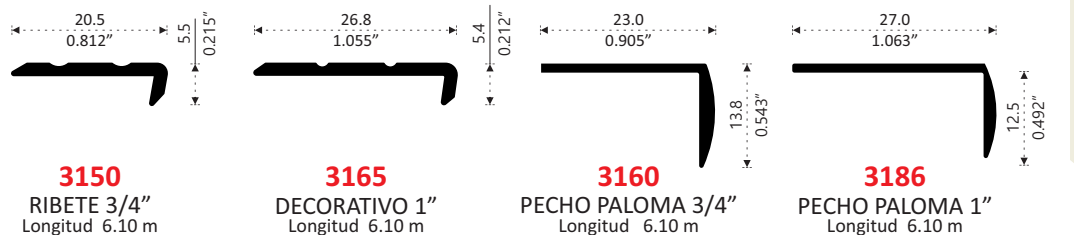

GUARDAPOLVOS

ELEGANTE POR SU DISEÑO

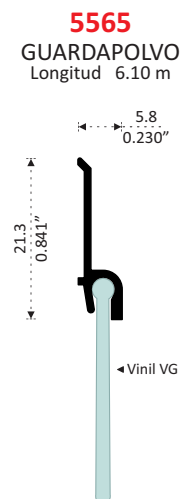
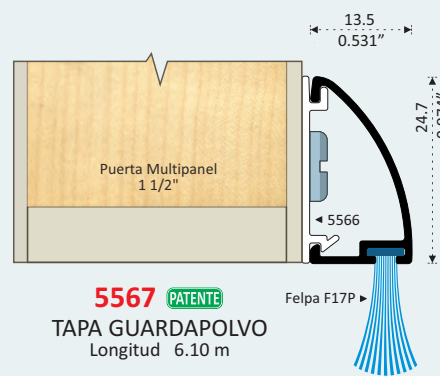
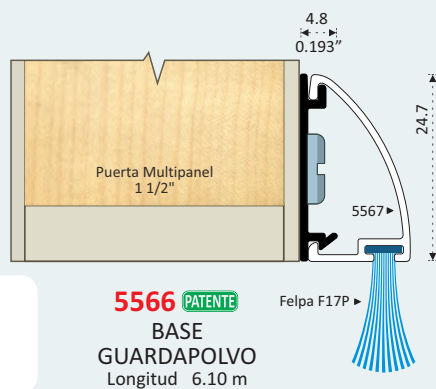

RIEL SUPERIOR PARA CARRETILLAS DE 12 RODAJAS SIN RIEL A PISO

COLOCACIÓN DE CARRETILLA

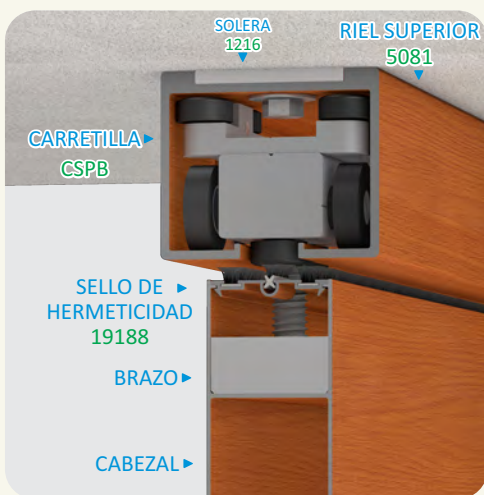

FIJACIÓN DE BARRA AL CABEZAL

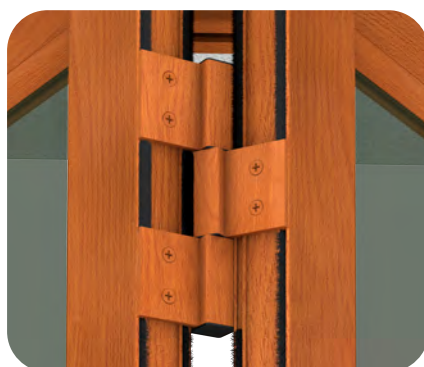

VISTA SUPERIOR

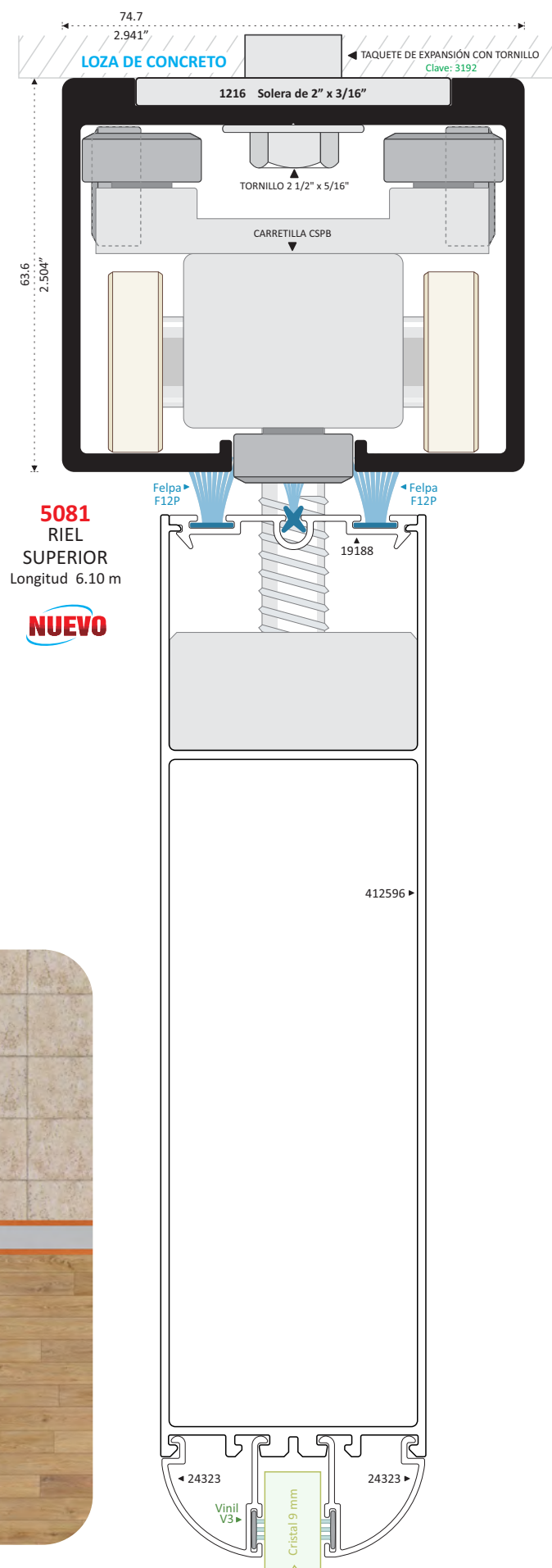

LÍNEA U - LIGHT

FIJO - VENTANA Y PUERTA CORREDIZA

FIJO	VENTANA con 15312	VENTANA con 11041	PUERTA con 11048
Zona Costera 1.20 m	Zona Costera 0.90 m	Zona Costera 1.00 m	Zona Costera 1.70 m
Campo Abierto 1.40 m	Campo Abierto 1.00 m	Campo Abierto 1.10 m	Campo Abierto 1.90 m
Residencial 1.60 m	Residencial 1.10 m	Residencial 1.20 m	Residencial 2.10 m
Interiores 1.80 m	Interiores 1.30 m	Interiores 1.40 m	Interiores 2.20 m

LÍNEA C - LIGHT

FIJO - VENTANA Y PUERTA CORREDIZA

FIJO	VENTANA con 15312	VENTANA con 11041	PUERTA con 11048
Zona Costera 1.20 m	Zona Costera 1.00 m	Zona Costera 1.10 m	Zona Costera 1.80 m
Campo Abierto 1.40 m	Campo Abierto 1.10 m	Campo Abierto 1.20 m	Campo Abierto 2.00 m
Residencial 1.60 m	Residencial 1.20 m	Residencial 1.30 m	Residencial 2.15 m
Interiores 1.80 m	Interiores 1.40 m	Interiores 1.50 m	Interiores 2.30 m

LÍNEA DE 2" ECONOMÍA HERMÉTICA

FIJO - VENTANA Y PUERTA CORREDIZA

LÍNEA DE 2" LIGHT HERMÉTICA

FIJO - VENTANA Y PUERTA CORREDIZA

LÍNEA DE 2" COMERCIAL HERMÉTICA

FIJO - VENTANA Y PUERTA CORREDIZA

VENTANA	PUERTA
Zona Costera 1.20 m	Zona Costera 1.90 m
Campo Abierto 1.30 m	Campo Abierto 2.00 m
Residencial 1.50 m	Residencial 2.10 m
Interiores 1.70 m	Interiores 2.15 m

VENTANA	PUERTA
Zona Costera 1.20 m	Zona Costera 1.90 m
Campo Abierto 1.30 m	Campo Abierto 2.00 m
Residencial 1.50 m	Residencial 2.10 m
Interiores 1.70 m	Interiores 2.15 m

FIJO	VENTANA	PUERTA	VENTANA DE PROYECCIÓN
Zona Costera 1.80 m	Zona Costera 1.30 m	Zona Costera 2.00 m	Zona Costera 0.70 m
Campo Abierto 2.00 m	Campo Abierto 1.40 m	Campo Abierto 2.10 m	Campo Abierto 1.00 m
Residencial 2.20 m	Residencial 1.60 m	Residencial 2.20 m	Residencial 1.30 m
Interiores 2.40 m	Interiores 1.80 m	Interiores 2.25 m	Interiores 1.60 m

LÍNEA DE 3" ECONOMÍA HERMÉTICA

FIJO - VENTANA Y PUERTA CORREDIZA

LÍNEA DE 3" COMERCIAL HERMÉTICA

FIJO - VENTANA Y PUERTA CORREDIZA

VENTANA	PUERTA	UTILIZANDO CERCO CHAPA 17847 Y TRASLAPE 17848
Zona Costera 1.80 m	Zona Costera 2.10 m	Zona Costera 2.25 m
Campo Abierto 1.90 m	Campo Abierto 2.20 m	Campo Abierto 2.40 m
Residencial 2.00 m	Residencial 2.30 m	Residencial 2.60 m
Interiores 2.10 m	Interiores 2.40 m	Interiores 2.80 m

FIJO	VENTANA	PUERTA	PUERTA BATIENTE MULTIDISEÑOS
Zona Costera 2.40 m	Zona Costera 2.10 m	Zona Costera 2.30 m	Zona Costera 2.30 m
Campo Abierto 2.60 m	Campo Abierto 2.20 m	Campo Abierto 2.40 m	Campo Abierto 2.50 m
Residencial 2.80 m	Residencial 2.40 m	Residencial 2.60 m	Residencial 2.70 m
Interiores 3.00 m	Interiores 2.60 m	Interiores 2.80 m	Interiores 2.90 m

LÍNEA SERIE 70

FIJO - VENTANA Y PUERTA CORREDIZA

FIJO	FIJO TRIPLE	FIJO CRISTAL DOBLE	VENTANA	PUERTA	VENTANA CRISTAL DOBLE	PUERTA CRISTAL DOBLE	VENTANA BATIENTE "Ó" PROYECCIÓN	PUERTA BATIENTE MULTI-DISEÑOS
Zona Costera 2.40 m	Zona Costera 2.60 m	Zona Costera 2.70 m	Zona Costera 1.90 m	Zona Costera 2.20 m	Zona Costera 2.20 m	Zona Costera 2.40 m	Zona Costera 1.00 m	Zona Costera 2.30 m
Campo Abierto 2.60 m	Campo Abierto 2.80 m	Campo Abierto 2.90 m	Campo Abierto 2.10 m	Campo Abierto 2.30 m	Campo Abierto 2.40 m	Campo Abierto 2.60 m	Campo Abierto 1.10 m	Campo Abierto 2.50 m
Residencial 2.80 m	Residencial 3.00 m	Residencial 3.10 m	Residencial 2.30 m	Residencial 2.40 m	Residencial 2.60 m	Residencial 2.80 m	Residencial 1.30 m	Residencial 2.70 m
Interiores 3.00 m	Interiores 3.20 m	Interiores 3.20 m	Interiores 2.40 m	Interiores 2.50 m	Interiores 2.80 m	Interiores 3.00 m	Interiores 1.50 m	Interiores 2.90 m

LÍNEA SERIE 80

FIJO - VENTANA Y PUERTA CORREDIZA

FIJO	FIJO TRIPLE	FIJO CRISTAL DOBLE	VENTANA CRISTAL SENCILLO/DOBLE	VENTANA BATIENTE "Ó" PROYECCIÓN	PUERTA CRISTAL SENCILLO/DOBLE	PUERTA BATIENTE MULTI-DISEÑOS
Zona Costera 2.40 m	Zona Costera 3.20 m	Zona Costera 3.20 m	Zona Costera 2.30 m	Zona Costera 1.00 m	Zona Costera 2.50 m	Zona Costera 2.30 m
Campo Abierto 2.60 m	Campo Abierto 3.40 m	Campo Abierto 3.40 m	Campo Abierto 2.40 m	Campo Abierto 1.10 m	Campo Abierto 2.60 m	Campo Abierto 2.50 m
Residencial 2.80 m	Residencial 3.60 m	Residencial 3.60 m	Residencial 2.50 m	Residencial 1.30 m	Residencial 2.70 m	Residencial 2.70 m
Interiores 3.00 m	Interiores 3.80 m	Interiores 3.80 m	Interiores 2.60 m	Interiores 1.50 m	Interiores 2.80 m	Interiores 2.90 m

LÍNEA SERIE 100 HERMÉTICA

FIJO - VENTANA Y PUERTA CORREDIZA

VENTANA	PUERTA	VENTANA CRISTAL DOBLE	PUERTA CRISTAL DOBLE	VENTANA BATIENTE "Ó" PROYECCIÓN	FIJO	FIJO CRISTAL DOBLE	FIJO TRIPLE	PUERTA BATIENTE MULTI-DISEÑOS
Zona Costera 2.10 m	Zona Costera 2.40 m	Zona Costera 2.30 m	Zona Costera 2.60 m	Zona Costera 1.00 m	Zona Costera 3.20 m	Zona Costera 3.20 m	Zona Costera 3.40 m	Zona Costera 2.30 m
Campo Abierto 2.20 m	Campo Abierto 2.60 m	Campo Abierto 2.40 m	Campo Abierto 2.70 m	Campo Abierto 1.10 m	Campo Abierto 3.40 m	Campo Abierto 3.40 m	Campo Abierto 3.60 m	Campo Abierto 2.50 m
Residencial 2.30 m	Residencial 2.80 m	Residencial 2.50 m	Residencial 2.90 m	Residencial 1.30 m	Residencial 3.60 m	Residencial 3.60 m	Residencial 3.80 m	Residencial 2.70 m
Interiores 2.50 m	Interiores 3.00 m	Interiores 2.60 m	Interiores 3.10 m	Interiores 1.50 m	Interiores 3.80 m	Interiores 3.80 m	Interiores 4.00 m	Interiores 2.90 m

LÍNEA SERIE 35

FIJO - VENTANA BATIENTE "O" PROYECCIÓN

FIJO	FIJO CRISTAL DOBLE	VENTANA BATIENTE "Ó" PROYECCIÓN (Corte 45°)
Zona Costera 1.40 m	Zona Costera 1.40 m	Zona Costera 0.60 m
Campo Abierto 1.60 m	Campo Abierto 1.60 m	Campo Abierto 0.90 m
Residencial 1.80 m	Residencial 1.80 m	Residencial 1.20 m
Interiores 2.00 m	Interiores 2.00 m	Interiores 1.50 m

LÍNEA SERIE 50

FIJO - VENTANA BATIENTE "O" PROYECCIÓN

FIJO	FIJO CRISTAL DOBLE	VENTANA BATIENTE "Ó" PROYECCIÓN (Corte 45°) 24396 / 54396	PUERTA BATIENTE MULTI-DISEÑOS
Zona Costera 1.80 m.	Zona Costera 1.80 m.	Zona Costera 1.00 m	Zona Costera 2.30 m
Campo Abierto 2.00 m.	Campo Abierto 2.00 m.	Campo Abierto 1.10 m	Campo Abierto 2.50 m
Residencial 2.20 m.	Residencial 2.20 m.	Residencial 1.30 m	Residencial 2.70 m
Interiores 2.40 m.	Interiores 2.40 m.	Interiores 1.50 m	Interiores 2.90 m

MOSQUITERO ENROLLABLE

VENTANA GUILLOTINA CADENA
RESORTE DE 42 cm

	MÍNIMO :	MÁXIMO :
ANCHO	60 cm	120 cm
ALTO	20 cm	120 cm

VENTANA CORREDIZA
RESORTE DE 42 cm

	MÍNIMO :	MÁXIMO :
ANCHO	20 cm	60 cm
ALTO	50 cm	120 cm

PUERTA GUILLOTINA CADENA
RESORTE 150 cm RESORTE DE 150 cm con Guía 30001

	MÍNIMO :	MÁXIMO :
ANCHO	60 cm	160 cm
ALTO	120 cm	240 cm

	MÍNIMO :	MÁXIMO :
ANCHO	60 cm	200 cm
ALTO	120 cm	240 cm

PUERTA CORREDIZA
RESORTE DE 150 cm

	MÍNIMO :	MÁXIMO :
ANCHO	60 cm	130 cm
ALTO	120 cm	240 cm

LÍNEA U - LIGHT

*(HM) Hoja Móvil (HF) Hoja fija

FIJO - VENTANA Y PUERTA CORREDIZA

FIJO			
CLAVE	DESCRIPCIÓN	PIEZAS	DESCUENTO
9073	Bolsa	1	Ancho - 5.48 cm
9073	Bolsa	2	Altura Real
49074	Escalonado	1	Ancho - 5.48 cm
46370	Junquillo	1	Ancho - 5.48 cm

VENTANA			
CLAVE	DESCRIPCIÓN	PIEZAS	DESCUENTO
15309	Contramarco	1	Ancho Real
15309	Contramarco	2	Altura - 2.0 cm
15310	Riel	1	Ancho Real
25313	Zoclo Fijo	1	Ancho + 2 - 3.94 cm
11041	Cerco (HF)	1	Altura - 3.69 cm
15311	Zoclo (HM)	2	Ancho + 2 - 4.75 cm
11041	Cerco (HM)	2	Altura - 2.95 cm

LÍNEA C - LIGHT

*(HM) Hoja Móvil (HF) Hoja fija

FIJO - VENTANA Y PUERTA CORREDIZA

FIJO			
CLAVE	DESCRIPCIÓN	PIEZAS	DESCUENTO
9073	Bolsa	1	Ancho - 5.48 cm
9073	Bolsa	2	Altura Real
49074	Escalonado	1	Ancho - 5.48 cm
46370	Junquillo	1	Ancho - 5.48 cm

VENTANA			
CLAVE	DESCRIPCIÓN	PIEZAS	DESCUENTO
611037	Contramarco	1	Ancho Real
11037	Contramarco	2	Altura - 2.0 cm
11068	Riel	1	Ancho Real
511046	Zoclo (HF)	1	Ancho ÷ 2 - 4.26 cm
11041	Cerco (HF)	1	Altura - 4.01 cm
11043	Zoclo (HM)	2	Ancho ÷ 2 - 4.75 cm
11041	Cerco (HM)	2	Altura - 3.1 cm

PUERTA			
CLAVE	DESCRIPCIÓN	PIEZAS	DESCUENTO
15309	Contramarco	1	Ancho Real
15309	Contramarco	2	Altura - 2.0 cm
15310	Riel	1	Ancho Real
25313	Zoclo Fijo	1	Ancho + 2 - 5.07 cm
11048	Cerco (HF)	1	Altura - 3.69 cm
15311	Zoclo (HM)	2	Ancho + 2 - 8.13 cm
11048	Cerco (HM)	2	Altura - 2.95 cm

VENTANA GUILLOTINA 1 1/2"			
CLAVE	DESCRIPCIÓN	PIEZAS	DESCUENTO
611037/11037	Contramarco	1	Ancho Real
11037	Contramarco	2	Altura - 1.62 cm
8670	Repizón	1	Ancho Real
11041	Traslape (HF)	1	Ancho - 6.02 cm
11041	Traslape (HM)	1	Ancho - 2.2 cm
8562	Cerco (HM)	1	Ancho - 2.2 cm
11043	Zoclo (HM)	2	Ancho ÷ 2 - 3.4 cm

PUERTA			
CLAVE	DESCRIPCIÓN	PIEZAS	DESCUENTO
611037	Contramarco	1	Ancho Real
11068	Riel	1	Altura - 2.0 cm
11037	Contramarco	2	Altura - 4.01 cm
511046	Zoclo (HF)	1	Ancho ÷ 2 - 5.39 cm
11048	Cerco (HF)	1	Altura - 3.1 cm
11043	Zoclo (HM)	2	Ancho Real
11048	Cerco (HM)	2	Ancho ÷ 2 - 8.13 cm

PUERTA BATIENTE

PUERTA BATIENTE / 9236			
CLAVE	DESCRIPCIÓN	PIEZAS	DESCUENTO
9255	Batiente Horiz.	1	Ancho - 3.8 cm
9255	Batiente Vert.	2	Altura Real
9236	Cerco Chapa	2	Altura - 3.36 cm
7838	Cabezal	1	Ancho - 5.02 cm
7838/7839	Zoclo Cabezal	1	Ancho - 5.02 cm
7837	Intermedio	1	Ancho - 16.9 cm

PUERTA BATIENTE / 19076			
CLAVE	DESCRIPCIÓN	PIEZAS	DESCUENTO
19076	Batiente Horiz.	1	Ancho - 5.48 cm
19076	Batiente Vert.	2	Altura Real
9236	Cerco Chapa	2	Altura - 4.24 cm
7838	Zoclo Cabezal	1	Ancho - 6.78 cm
7838/7839	Zoclo Cabezal	1	Ancho - 6.78 cm
7837	Intermedio	1	Ancho - 18.66 cm

LÍNEA DE 2" ECONÓMICA HERMÉTICA

FIJO			
CLAVE	DESCRIPCIÓN	PIEZAS	DESCUENTO
69083	Bolsa	1	Ancho - 6.34 cm
69083	Bolsa	2	Altura Real
69084	Escalonado	1	Ancho - 6.34 cm
69088	Junquillo	1	Ancho - 6.34 cm

VENTANA CORREDIZA			
CLAVE	DESCRIPCIÓN	PIEZAS	DESCUENTO
S77518	Contramarco Hor.	1	Ancho Real
T77518	Contramarco Vertical	2	Altura - 2.0 cm
79953	Riel	1	Ancho Real
77523	Zoclo Fijo	2	Ancho ÷ 2 - 4.42 cm
67525	Cerco Fijo	1	Altura - 2.0 cm
79954	Traslape Ventana (HF)	1	Altura - 2.0 cm
711044	Zoclo y Cabezal	2	Ancho ÷ 2 - 6.64 cm
67821	Cerco Chapa	1	Altura - 3.15 cm
79954	Traslape Ventana (HM)	1	Altura - 3.15 cm

PUERTA CORREDIZA			
CLAVE	DESCRIPCIÓN	PIEZAS	DESCUENTO
S77518	Contramarco Hor.	1	Ancho Real
T77518	Contramarco Vertical	2	Altura - 2.0 cm
79953	Riel	1	Ancho Real
77824	Zoclo Puerta Fijo	2	Ancho ÷ 2 - 4.42 cm
67525	Cerco Fijo	1	Altura - 2.0 cm
79955	Traslape Puerta	1	Altura - 2.0 cm
77825	Zoclo Puerta	2	Ancho ÷ 2 - 6.64 cm
67821	Cerco Chapa	1	Altura - 3.15 cm
79955	Traslape Puerta	1	Altura - 3.15 cm

PUERTA BATIENTE SAN LUIS

Batiente 28591

PUERTA BATIENTE SAN LUIS			
CLAVE	DESCRIPCIÓN	PIEZAS	DESCUENTO
28591	Batiente	1	Ancho - 6.34 cm
28591	Batiente	2	Altura Real
79203	Cerco Chapa	2	Altura - 4.67 cm
79187	Zoclo y Cabezal	1	Ancho - 18.04 cm
712596	Zoclo y Cabezal	1	Ancho - 18.4 cm
19188	Sello de Hermeticidad	2	Ancho - 8.24 cm
76371	Junquillo Biselado	4	Ancho - 18.4 cm
76371	Junquillo Biselado	4	Ancho - 19.91 cm

LÍNEA DE 2" LIGHT HERMÉTICA

FIJO			
CLAVE	DESCRIPCIÓN	PIEZAS	DESCUENTO
69083	Bolsa	1	Ancho - 6.34 cm
69084	Escalonado	1	Ancho - 6.34 cm
69088	Junquillo	1	Ancho - 6.34 cm
69083	Bolsa	2	Altura Real

VENTANA CORREDIZA			
CLAVE	DESCRIPCIÓN	PIEZAS	DESCUENTO
S67518	Contramarco Hor.	1	Ancho Real
T67518	Contramarco Vertical	2	Altura - 2.61 cm
69953	Riel	1	Ancho Real
67523	Zoclo Fijo	2	Ancho ÷ 2 - 4.73 cm
67525	Cerco Fijo	1	Altura - 2.61 cm
69954	Traslape Ventana	1	Altura - 2.61 cm
611044	Zoclo y Cabezal	2	Ancho ÷ 2 - 6.95 cm
67821	Cerco Chapa	1	Altura - 3.7 cm
69954	Traslape Ventana	1	Altura - 3.7 cm

PUERTA CORREDIZA			
CLAVE	DESCRIPCIÓN	PIEZAS	DESCUENTO
S67518	Contramarco Hor.	1	Ancho Real
T67518	Contramarco Vertical	2	Altura - 2.61 cm
69953	Riel	1	Ancho Real
67824	Zoclo Puerta Fijo	2	Ancho ÷ 2 - 4.73 cm
67525	Cerco Fijo	1	Altura - 2.61 cm
69955	Traslape Puerta	1	Altura - 2.61 cm
67825	Zoclo Puerta	2	Ancho ÷ 2 - 9.17 cm
67821	Cerco Chapa	1	Altura - 3.7 cm
69955	Traslape Puerta	1	Altura - 3.7 cm

PUERTA BATIENTE SAN LUIS			
CLAVE	DESCRIPCIÓN	PIEZAS	DESCUENTO
78591	Batiente	1	Ancho - 6.34 cm
78591	Batiente	2	Altura Real
79204	Cerco Chapa	2	Altura - 4.67 cm
79187	Zoclo y Cabezal	1	Ancho - 18.4 cm
712596	Zoclo y Cabezal	1	Ancho - 18.4 cm
19188	Sello de Hermeticidad	2	Ancho - 8.44 cm
76372	Junquillo Curvo	4	Ancho - 18.4 cm
76372	Junquillo Curvo	4	Ancho - 35.07 cm

LÍNEA DE 2" COMERCIAL HERMÉTICA FIJO - VENTANA Y PUERTA CORREDIZA

FIJO

CLAVE	DESCRIPCIÓN	PIEZAS	DESCUENTO
9083	Bolsa	1	Ancho - 6.34 cm
9083	Bolsa	2	Altura Real
9084	Escalonado	1	Ancho - 6.34 cm
9088	Junquillo	1	Ancho - 6.34 cm

VENTANA CORREDIZA

CLAVE	DESCRIPCIÓN	PIEZAS	DESCUENTO
S7518	Contramarco Hor.	1	Ancho Real
T7518	Contramarco Vertical	2	Altura - 2.65 cm
9953	Riel	1	Ancho Real
7815	Zoclo con Base	2	Ancho ÷ 2 - 4.57 cm
7525	Cerco Fijo	1	Altura - 2.65 cm
9954	Traslape Ventana (HF)	1	Altura - 2.65 cm
11044	Zoclo y Cabezal	2	Ancho ÷ 2 - 8.67 cm
8320	Cerco Chapa	1	Altura - 3.64 cm
9954	Traslape Ventana (HM)	1	Altura - 3.64 cm

PUERTA CORREDIZA

CLAVE	DESCRIPCIÓN	PIEZAS	DESCUENTO
S7518	Contramarco Hor.	1	Ancho Real
T7518	Contramarco Vertical	2	Altura - 2.65 cm
9953	Riel	1	Ancho Real
7824	Zoclo Puerta Fijo	2	Ancho ÷ 2 - 5.04 cm
7525	Cerco Fijo	1	Altura - 2.65 cm
9955	Traslape Puerta (HF)	1	Altura - 2.65 cm
7825	Zoclo Puerta	2	Ancho ÷ 2 - 10.08 cm
7821	Cerco Chapa	1	Altura - 3.64 cm
9955	Traslape Puerta (HM)	1	Altura - 3.64 cm

PUERTA CORREDIZA GRAN VISTA

CLAVE	DESCRIPCIÓN	PIEZAS	DESCUENTO
S7518	Contramarco	1	Ancho Real
T7518	Contramarco	2	Altura - 2.65 cm
9953	Riel	1	Ancho Real
7824	Zoclo Puerta Fijo	2	Ancho + 2 - 9.22 cm
17821	Cerco Chapa Gran Vista	1	Altura - 2.65 cm
19955	Traslape Gran Vista	1	Altura - 2.65 cm
7825	Zoclo Puerta	2	Ancho + 2 - 16.58 cm
17821	Cerco Chapa Gran Vista	1	Altura - 3.64 cm
19955	Traslape Gran Vista	1	Altura - 3.64 cm

PUERTA BATIENTE COMERCIAL

PUERTA BATIENTE COMERCIAL

CLAVE	DESCRIPCIÓN	PIEZAS	DESCUENTO
35844	Batiente	1	Ancho - 3.8 cm
35844	Batiente	2	Altura Real
69204	Cerco Chapa	2	Altura - 3.4 cm
69207	Cabezal Puerta	1	Ancho - 15.66 cm
69187	Zoclo Puerta	1	Ancho - 15.66 cm
69183	Intermedio	1	Ancho - 15.66 cm
19188	Sello de Hermeticidad	2	Ancho - 5.7 cm
6370	Junquillo	4	Ancho - 15.66 cm
6370	Junquillo	4	Altura - 19.2 cm

GUILLOTINA

VENTANA GUILLOTINA 2"

CLAVE	DESCRIPCIÓN	PIEZAS	DESCUENTO
T7518	Contramarco	1	Ancho Real
7518	Contramarco	2	Altura - 2.02 cm
8671	Repizón Guillotina	1	Ancho Real
7525	Cerco Fijo	1	Ancho - 2.7 cm
9954	Traslape Ventana	1	Ancho - 2.7 cm
7815	Zoclo con Base	2	Altura ÷ 2 - 4.92 cm
9954	Traslape Ventana	1	Ancho - 2.9 cm
8562	Cerco Jaladera	1	Ancho - 2.9 cm
611044	Zoclo y Cabezal	2	Altura ÷ 2 - 9.02 cm

SIFÓN

VENTANA SIFÓN

CLAVE	DESCRIPCIÓN	PIEZAS	DESCUENTO
9083	Bolsa	1	Ancho - 6.34 cm
9083	Bolsa	2	Altura Real
9079	Tapa Sifón	1	Ancho - 7.5 cm
9080	Escalonado Sifón	1	Ancho - 6.34 cm
9081	Repizón Sifón	1	Ancho - 6.34 cm
9088	Junquillo	1	Ancho - 6.34 cm
20554	Mosquitero Sifón	2	Ancho - 6.34 cm
20554	Mosquitero Sifón	2	De 4.82 cm

VENTANA DE PROYECCIÓN COLONIAL

CLAVE	DESCRIPCIÓN	PIEZAS	DESCUENTO
8937	Contramarco	2	Ancho - 2.28 cm
8937	Contramarco	2	Altura Real
8936	Marco Tubular	2	Ancho - 2.68 cm
8936	Marco Tubular	2	Altura - 2.68 cm
9111	Junquillo	2	Ancho - 10.08 cm
9111	Junquillo	2	Altura - 10.08 cm

VENTANA DE PROYECCIÓN Ó ABATIBLE GRAN VISTA

CLAVE	DESCRIPCIÓN	PIEZAS	DESCUENTO
9091 / 69091	Contramarco	2	Ancho Real
9091 / 69091	Contramarco	2	Altura Real
52274	Marco Colonial	2	Ancho - 5.2 cm
52274	Marco Colonial	2	Altura - 5.2 cm

LÍNEA DE 3" ECONÓMICA HERMÉTICA

VENTANA CORREDIZA

CLAVE	DESCRIPCIÓN	PIEZAS	DESCUENTO
S77826	Contramarco Hor.	1	Ancho Real
T77826	Contramarco Ver.	2	Altura - 1.98 cm
79957	Riel	1	Ancho Real
7833	Zoclo Fijo	2	Ancho ÷ 2 - 4.79 cm
8681	Cerco Fijo	1	Altura - 1.98 cm
77848	Traslape	1	Altura - 1.98 cm
7835	Zoclo Ventana	2	Ancho ÷ 2 - 9.94 cm
67847	Cerco Chapa	1	Altura - 3.0 cm
77848	Traslape	1	Altura - 3.0 cm

PUERTA CORREDIZA

CLAVE	DESCRIPCIÓN	PIEZAS	DESCUENTO
S77826	Contramarco Hor.	1	Ancho Real
T77826	Contramarco Ver.	2	Altura - 1.98 cm
79957	Riel	1	Ancho Real
7845	Zoclo Puerta Fijo	2	Ancho ÷ 2 - 4.79 cm
8681	Cerco Fijo	1	Altura - 1.98 cm
77848	Traslape	1	Altura - 1.98 cm
7842	Zoclo Puerta	2	Ancho ÷ 2 - 9.94 cm
67847	Cerco Chapa	1	Altura - 3.0 cm
77848	Traslape	1	Altura - 3.0 cm

LÍNEA DE 3" LIGHT

FIJO

CLAVE	DESCRIPCIÓN	PIEZAS	DESCUENTO
69135	Bolsa	1	Ancho - 8.88 cm
69135	Bolsa	2	Altura Real
69136	Escalonado	1	Ancho - 8.8 cm
69112	Junquillo	1	Ancho - 8.8 cm

LÍNEA DE 3"

FIJO

CLAVE	DESCRIPCIÓN	PIEZAS	DESCUENTO
9135	Bolsa	1	Ancho - 8.88 cm
9135	Bolsa	2	Altura Real
9136	Escalonado	1	Ancho - 8.8 cm
9112	Junquillo	1	Ancho - 8.8 cm

LÍNEA DE 3" LIGHT HERMÉTICA

VENTANA CORREDIZA

CLAVE	DESCRIPCIÓN	PIEZAS	DESCUENTO
S67826	Contramarco HrZ	1	Ancho Real
T67826	Contramarco Vert	2	Altura - 2.6 cm
9957	Riel	1	Ancho Real
7833	Zoclo Fijo	2	Ancho / 2 - 5.13 cm
8681	Cerco Fijo	1	Altura - 2.6 cm
67848	Traslape	1	Altura - 2.6 cm
7835	Zoclo Ventana	2	Ancho / 2 - 10.28 cm
67847	Cerco Chapa	1	Altura - 3.6 cm
67848	Traslape	1	Altura - 3.6 cm

PUERTA CORREDIZA

CLAVE	DESCRIPCIÓN	PIEZAS	DESCUENTO
S67826	Contramarco HrZ	1	Ancho Real
T67826	Contramarco Vert	2	Altura - 2.6 cm
9957	Riel	1	Ancho Real
7845	Zoclo Puerta Fijo	2	Ancho / 2 - 5.13 cm
8681	Cerco Fijo	1	Altura - 2.6 cm
67848	Traslape	1	Altura - 2.6 cm
7842	Zoclo Puerta	2	Ancho / 2 - 10.28 cm
67847	Cerco Chapa	1	Altura - 3.6 cm
67848	Traslape	1	Altura - 3.6 cm

LÍNEA DE 3" COMERCIAL HERMÉTICA

RIEL CON INCLINACIÓN

VENTANA Y PUERTA CORREDIZA

CLAVE	DESCRIPCIÓN	PIEZAS	DESCUENTO
S7826	Contramarco HrZ	1	Ancho Real
T7826	Contramarco Vert	2	Altura - 2.6 cm
9957	Riel	1	Ancho Real
7833/7845	Zoclo Fijo	2	Ancho ÷ 2 - 5.34 cm
8681	Cerco Fijo	1	Altura - 2.6 cm
7848	Traslape (HF)	1	Altura - 2.6 cm
7835/7842	Zoclo y Cabezal	2	Ancho ÷ 2 - 10.94
7847	Cerco Chapa	1	Altura - 3.6 cm
7848	Traslape (HM)	1	Altura - 3.6 cm

PUERTA CORREDIZA

CLAVE	DESCRIPCIÓN	PIEZAS	DESCUENTO
S7826	Contramarco HrZ	1	Ancho Real
T7826	Contramarco Vert	2	Altura - 2.65 cm
i9957	Riel con Inclinación	1	Ancho Real
7845	Zoclo Puerta Fijo	2	Ancho ÷ 2 - 5.34 cm
8681	Cerco Fijo	1	Altura - 2.65 cm
7848	Traslape	1	Altura - 2.65 cm
7842	Zoclo Puerta	2	Ancho ÷ 2 - 10.94
7847	Cerco Chapa	1	Altura - 4.39 cm
7848	Traslape	1	Altura - 4.39 cm

LÍNEA 3" GRAN VISTA

VENTANA Y PUERTA CORREDIZA

CLAVE	DESCRIPCIÓN	PIEZAS	DESCUENTO
S7826	Contramarco Hrz	1	Ancho Real
T7826	Contramarco Vert	2	Altura - 2.6 cm
9957	Riel	1	Ancho Real
7845	Zoclo Fijo Fijo	2	Ancho + 2 - 9.5 cm
17847	Cerco Chapa (HF)	1	Altura - 2.6 cm
17848	Traslape (HF)	1	Altura - 2.6 cm
7842	Zoclo Puerta	2	Ancho + 2 - 17.1 cm
17847	Cerco Chapa (HM)	1	Altura - 3.6 cm
17848	Traslape (HM)	1	Altura - 3.6 cm

LÍNEA 3" PLUS

VENTANA Y PUERTA CORREDIZA

CLAVE	DESCRIPCIÓN	PIEZAS	DESCUENTO
17826	Contramarco Hor	1	Ancho Real
T7826	Contramarco Vert	2	Altura - 2.2 cm
19957	Riel	1	Ancho Real
27842	Zoclo Puerta Fijo	2	Ancho ÷ 2 - 2.19 cm
17847	Cerco Chapa (HF)	1	Altura - 2.2 cm
17848	Traslape (HF)	1	Altura - 2.2 cm
17842	Zoclo Puerta	2	Ancho ÷ 2 + 5.41 cm
17847	Cerco Chapa	1	Altura - 3.2 cm
17848	Traslape (HM)	1	Altura - 3.2 cm

LÍNEA 3" CRISTAL DOBLE

FIJO 1 1/4"

CLAVE	DESCRIPCIÓN	PIEZAS	DESCUENTO
28270	Bolsa	1	Ancho - 6.34 cm
28270	Bolsa	2	Altura Real
28183	Escalonado	1	Ancho - 6.34 cm
38184	Junquillo	1	Ancho - 6.34 cm

VENTANA CORREDIZA

CLAVE	DESCRIPCIÓN	PIEZAS	DESCUENTO
S7826	Contramarco Hrz	1	Ancho Real
T7826	Contramarco Vert	2	Altura - 2.6 cm
9957	Riel	1	Ancho Real
9959	Zoclo Puerta (HF)	2	Ancho ÷ 2 - 5.34 cm
9965	Cerco Fijo (HF)	1	Altura - 2.6 cm
9963	Traslape (HF)	1	Altura - 2.6 cm
9959	Zoclo Puerta (HM)	2	Ancho ÷ 2 - 10.44 cm
9964	Cerco Chapa (HM)	1	Altura - 3.6 cm
9963	Traslape (HM)	1	Altura - 3.6 cm

FIJO 1 3/4"

CLAVE	DESCRIPCIÓN	PIEZAS	DESCUENTO
38270	Bolsa	1	Ancho - 8.88 cm
38270	Bolsa	2	Altura Real
38183	Escalonado	1	Ancho - 8.88 cm
38184	Junquillo	1	Ancho - 8.88 cm

VENTANA PROYECCIÓN O ABATIBLE 3"

VENTANA PROYECCIÓN O ABATIBLE 3"

CLAVE	DESCRIPCIÓN	PIEZAS	DESCUENTO
9130	Contramarco	2	Ancho Real
9130	Contramarco	2	Altura Real
54395	Marco de Hoja	2	Ancho - 5.22 cm
54395	Marco de Hoja	2	Altura - 5.22 cm
24323	Junquillo	4	Ancho - 20.72 cm
24323	Junquillo	4	Altura - 20.72 cm

GUILLOTINA 3"

VENTANA GUILLOTINA 3"

CLAVE	DESCRIPCIÓN	PIEZAS	DESCUENTO
T7826	Contramarco	1	Ancho Real
7826	Contramarco	2	Altura - 2.41 cm
8565	Repizón Guillotina	1	Ancho Real
8681	Cerco Fijo	1	Ancho - 2.44 cm
7848	Traslape (HF)	1	Ancho - 2.44 cm
7833	Zoclo Fijo	2	Altura + 2 - 7.59 cm
7848	Traslape (HM)	1	Ancho - 2.64 cm
8564	Cerco Jaladera	1	Ancho - 2.64 cm
7835	Zoclo (HM)	2	Altura + 2 - 13.19 cm
11763	Mosquitero Fijo	2	Ancho - 3.28 cm
11763	Mosquitero Fijo	2	Altura + 2 - 6.98 cm

SIFÓN 3"

VENTANA SIFÓN CRISTAL SENCILLO

CLAVE	DESCRIPCIÓN	PIEZAS	DESCUENTO
9135	Bolsa	1	Ancho - 8.88 cm
9135	Bolsa	2	Altura Real
10466	Tapa Sifón	1	Ancho - 10.04 cm
10465	Escalonado Sifón	1	Ancho - 8.88 cm
10467	Repizón Sifón	1	Ancho - 8.88 cm
9112	Junquillo	1	Ancho - 8.88 cm
20554	Mosquitero Sifón	2	Ancho - 8.88 cm
20554	Mosquitero Sifón	2	De 7.34 cm

PUERTA BATIENTE MULTIDISEÑOS 3"

CLAVE	DESCRIPCIÓN	PIEZAS	DESCUENTO
9134	Batiente	1	Ancho - 8.88 cm
9134	Batiente	2	Altura Real
412544	Cerco Chapa	2	Altura - 5.94 cm
412596	Cabezal	1	Ancho - 30.5 cm
412596	Zoclo	1	Ancho - 30.5 cm
19188	Sello de Hermeticidad	2	Ancho - 10.98 cm
24323	Junquillo	4	Ancho - 30.5 cm
24323	Junquillo	4	Altura - 36.34 cm

VENTANA SIFÓN CRISTAL DOBLE

CLAVE	DESCRIPCIÓN	PIEZAS	DESCUENTO
38270	Bolsa	1	Ancho - 8.88 cm
38270	Bolsa	2	Altura Real
10466	Tapa Sifón	1	Ancho - 10.04 cm
20465	Escalonado Sifón	1	Ancho - 8.88 cm
10467	Repizón Sifón	1	Ancho - 8.88 cm
38184	Junquillo	1	Ancho - 8.88 cm
20554	Mosquitero Sifón	2	Ancho - 8.88 cm
20554	Mosquitero Sifón	2	De 7.34 cm

LÍNEA SERIE 70 FIJO - VENTANA Y PUERTA CORREDIZA

FIJO

CLAVE	DESCRIPCIÓN	PIEZAS	DESCUENTO
22504	Bolsa	1	Ancho - 9.0 cm
22504	Bolsa	2	Altura Real
32506	Escalonado	1	Ancho - 9.0 cm
42507	Junquillo	1	Ancho - 9.0 cm

FIJO ESCALONADO GRAN VISTA

CLAVE	DESCRIPCIÓN	PIEZAS	DESCUENTO
32508	Escalonado	2	Ancho Real
32508	Escalonado	2	Altura Real
24323	Junquillo	2	Ancho - 19.6 cm
24323	Junquillo	2	Altura - 19.6 cm

VENTANA CORREDIZA

CLAVE	DESCRIPCIÓN	PIEZAS	DESCUENTO
628407	Riel y Cabezal	2	Ancho - 2.14 cm
628408	Jamba	2	Altura Real
28411	Cerco Chapa	2	Altura - 3.4 cm
28412	Traslape Ventana	2	Altura - 3.4 cm
22547	Zoclo y Cabezal	4	Ancho ÷ 2 + 1.05 cm

PUERTA CORREDIZA

CLAVE	DESCRIPCIÓN	PIEZAS	DESCUENTO
628407	Riel y Cabezal	2	Ancho - 2.14 cm
628408	Jamba	2	Altura Real
28409	Cerco Chapa Puerta	2	Altura - 3.4 cm
28410	Traslape Puerta	2	Altura - 3.4 cm
22263	Zoclo y Cabezal	4	Ancho ÷ 2 + 1.05 cm

LÍNEA SERIE 70 TRIPLE

FIJO - VENTANA Y PUERTA CORREDIZA

FIJO TRIPLE

CLAVE	DESCRIPCIÓN	PIEZAS	DESCUENTO
6608 / 62369	Bolsa	1	Ancho - 8.9 cm
6608 / 62369	Bolsa	2	Altura Real
6607 / 62370	Escalonado	1	Ancho - 8.9 cm
6606 / 62371	Junquillo	1	Ancho - 8.9 cm

VENTANA CORREDIZA TRIPLE

CLAVE	DESCRIPCIÓN	PIEZAS	DESCUENTO
662373	Riel y Cabezal	2	Ancho - 3.6 cm
662374	Jamba Triple	2	Altura Real
28411	Cerco Chapa	2	Altura - 3.4 cm
28412	Traslape	4	Altura - 3.4 cm
22547	Zoclo y Cabezal	6	Ancho ÷ 3 + 1.17 cm

PUERTA CORREDIZA TRIPLE

CLAVE	DESCRIPCIÓN	PIEZAS	DESCUENTO
662373	Riel y Cabezal	2	Ancho - 3.6 cm
662374	Jamba Triple	2	Altura Real
28409	Cerco Chapa	2	Altura - 3.4 cm
28410	Traslape	4	Altura - 3.4 cm
22263	Zoclo y Cabezal	6	Ancho ÷ 3 + 2.39 cm

LÍNEA SERIE 70 TRIPLE

FIJO - VENTANA Y PUERTA CORREDIZA

LÍNEA SERIE 70 RIEL SENCILLO

VENTANA CORREDIZA TRIPLE CON MOSQUITERO

CLAVE	DESCRIPCIÓN	PIEZAS	DESCUENTO
662373	Riel y Cabezal	2	Ancho - 3.6 cm
662374	Jamba Triple	2	Altura Real
28411	Cerco Chapa	2	Altura - 3.4 cm
28412	Traslape	4	Altura - 3.4 cm
22547	Zoclo y Cabezal	6	Ancho + 2 - 0.6 cm
62377	Adaptador Cerco	2	Altura - 3.4 cm
62378	Tapa Cerco	2	Altura - 3.4 cm
72376	Adaptador Mosquitero	2	Ancho + 2 - 12.14 cm
72376	Adaptador Mosquitero	2	Altura - 21.04 cm

PUERTA CORREDIZA TRIPLE CON MOSQUITERO

CLAVE	DESCRIPCIÓN	PIEZAS	DESCUENTO
662373	Riel y Cabezal	2	Ancho - 3.6 cm
662374	Jamba Triple	2	Altura Real
28409	Cerco Chapa	2	Altura - 3.4 cm
28410	Traslape	4	Altura - 3.4 cm
22263	Zoclo y Cabezal	6	Ancho + 2 + 0.32 cm
62377	Adaptador Cerco	2	Altura - 3.4 cm
62378	Tapa Cerco	2	Altura - 3.4 cm
72376	Adaptador Mosquitero	2	Ancho + 2 - 14.86 cm
72376	Adaptador Mosquitero	2	Altura - 21.04 cm

PUERTA CORREDIZA RIEL SENCILLO 3 HOJAS

CLAVE	DESCRIPCIÓN	PIEZAS	DESCUENTO
28402	Riel Superior	2	Ancho - 2.6 cm
28402	Riel Superior	1	Ancho Real
28403	Jamba Sencilla	2	Altura Real
28401	Riel Sencillo	2	Ancho - 2.6 cm
28401	Riel Sencillo	1	Ancho Real
28409	Cerco Chapa	2	Altura - 2.1 cm
28410	Traslape Puerta	4	Altura - 2.1 cm
22263	Zoclo y Cabezal	3	Ancho + 3 + 2.59 cm
68412	Zoclo (Inferior)	3	Ancho + 3 + 2.59 cm

LÍNEA SERIE 70 CRISTAL DOBLE

FIJO CRISTAL DOBLE

CLAVE	DESCRIPCIÓN	PIEZAS	DESCUENTO
22592	Bolsa	1	Ancho - 9.0 cm
22592	Bolsa	2	Altura Real
22593	Escalonado	1	Ancho - 9.0 cm
12507	Junquillo Cristal Doble	1	Ancho - 9.0 cm

FIJO TRIPLE CRISTAL DOBLE

CLAVE	DESCRIPCIÓN	PIEZAS	DESCUENTO
6610	Bolsa	1	Ancho - 8.9 cm
6610	Bolsa	2	Altura Real
6611	Escalonado	1	Ancho - 8.9 cm
6612	Junquillo Cristal Doble	1	Ancho - 8.9 cm

PUERTA CORREDIZA RIEL DOBLE CRISTAL DOBLE

CLAVE	DESCRIPCIÓN	PIEZAS	DESCUENTO
628407	Riel y Cabezal	2	Ancho - 2.14 cm
628408	Jamba	2	Altura Real
28419	Cerco Chapa	2	Altura - 3.4 cm
28420	Traslape Puerta	2	Altura - 3.4 cm
12437	Zoclo y Cabezal	4	Ancho + 2 + 1.08 cm

PUERTA CORREDIZA RIEL TRIPLE CRISTAL DOBLE

CLAVE	DESCRIPCIÓN	PIEZAS	DESCUENTO
662373	Riel y Cabezal	2	Ancho - 3.6 cm
662374	Jamba	2	Altura Real
28419	Cerco Chapa Puerta	2	Altura - 3.4 cm
28420	Traslape Puerta	4	Altura - 3.4 cm
12437	Zoclo y Cabezal	6	Ancho + 3 + 2.44 cm

VENTANA PROYECCIÓN O ABATIBLE SERIE 70

VENTANA PROYECCIÓN O ABATIBLE

CLAVE	DESCRIPCIÓN	PIEZAS	DESCUENTO
74396	Contramarco	2	Ancho Real
74396	Contramarco	2	Altura Real
54395	Marco de Hoja	2	Ancho - 5.22 cm
54395	Marco de Hoja	2	Altura - 5.22 cm
24323	Junquillo	4	Ancho - 20.72 cm
24323	Junquillo	4	Altura - 20.72 cm
22271	Contramarco Mosquitero	2	Ancho Real
22271	Contramarco Mosquitero	2	Altura Real
22270	Marco Mosquitero	2	Ancho - 3.4 cm
22270	Marco Mosquitero	2	Altura - 3.4 cm

PUERTA BATIENTE MULTIDISEÑOS SERIE 70

PUERTA BATIENTE MULTIDISEÑOS

CLAVE	DESCRIPCIÓN	PIEZAS	DESCUENTO
12619	Batiente	1	Ancho Real
12619	Batiente	2	Altura Real
412544	Cerco Chapa	2	Altura - 4.77 cm
19187	Cabezal	1	Ancho - 28.16 cm
412596	Zoclo	1	Ancho - 28.16 cm
19188	Sello de Hermeticidad	2	Ancho - 8.64 cm
24323	Junquillo	4	Ancho - 28.16 cm
24323	Junquillo	4	Altura - 35.17 cm

LÍNEA SERIE 80 FIJO - VENTANA Y PUERTA CORREDIZA

FIJO

CLAVE	DESCRIPCIÓN	PIEZAS	DESCUENTO
22504	Bolsa	1	Ancho - 9.0 cm
22504	Bolsa	2	Altura Real
32506	Escalonado	1	Ancho - 9.0 cm
42507	Junquillo	1	Ancho - 9.0 cm

FIJO ESCALONADO GRAN VISTA

CLAVE	DESCRIPCIÓN	PIEZAS	DESCUENTO
32508	Escalonado	2	Ancho Real
32508	Escalonado	2	Altura Real
24323	Junquillo	2	Ancho - 19.6 cm
24323	Junquillo	2	Altura - 19.6 cm

CORREDIZA RIEL DOBLE VINIL RESPALDO

CLAVE	DESCRIPCIÓN	PIEZAS	DESCUENTO
638407	Riel y Cabezal	2	Ancho - 3.4 cm
648408	Jamba	2	Altura Real
48409	Cerco Chapa	2	Altura - 3.4 cm
68410	Traslape	2	Altura - 3.4 cm
62263	Zoclo y Cabezal	4	Ancho + 2 + 0.39 cm

CORREDIZA RIEL DOBLE VINIL CUÑA

CLAVE	DESCRIPCIÓN	PIEZAS	DESCUENTO
638407	Riel y Cabezal	2	Ancho - 3.4 cm
648408	Jamba	2	Altura Real
38411	Cerco Chapa	2	Altura - 3.4 cm
38410	Traslape	2	Altura - 3.4 cm
32263	Zoclo y Cabezal	4	Ancho + 3 - 0.25 cm

LÍNEA SERIE 80 TRIPLE

FIJO - VENTANA Y PUERTA CORREDIZA

FIJO TRIPLE

CLAVE	DESCRIPCIÓN	PIEZAS	DESCUENTO
13614	Bolsa	1	Ancho - 10.16 cm
13614	Bolsa	2	Altura Real
13617	Escalonado	1	Ancho - 10.6 cm
13616	Junquillo	1	Ancho - 10.6 cm

CORREDIZA RIEL TRIPLE VINIL RESPALDO

CLAVE	DESCRIPCIÓN	PIEZAS	DESCUENTO
648407	Riel y Cabezal	2	Ancho - 3.6 cm
668408	Jamba Triple	2	Altura Real
48409	Cerco Chapa	2	Altura - 3.44 cm
68410	Traslape	4	Altura - 3.44 cm
62263	Zoclo y Cabezal	6	Ancho + 3 + 1.86 cm

CORREDIZA RIEL TRIPLE VINIL CUÑA

CLAVE	DESCRIPCIÓN	PIEZAS	DESCUENTO
648407	Riel y Cabezal	2	Ancho - 3.6 cm
668408	Jamba Triple	2	Altura Real
38411	Cerco Chapa	2	Altura - 3.44 cm
38410	Traslape	4	Altura - 3.44 cm
32263	Zoclo y Cabezal	6	Ancho + 3 + 1.8 cm

LÍNEA SERIE 80 TRIPLE

CORREDIZA CON MOSQUITERO

RIEL TRIPLE VINIL CUÑA

CLAVE	DESCRIPCIÓN	PIEZAS	DESCUENTO
648407	Riel y Cabezal	2	Ancho - 3.6 cm
668408	Jamba Triple	2	Altura Real
38411	Cerco Chapa	2	Altura - 3.44 cm
38410	Traslape	4	Altura - 3.44 cm
32263	Zoclo y Cabezal	6	Ancho + 2 - 0.55 cm
38412	Adaptador Cerco	2	Altura - 3.44 cm
48416	Tapa Cerco	2	Altura - 3.44 cm
38413	Adaptador Mosquitero	2	Ancho + 2 - 15.35 cm
38413	Adaptador Mosquitero	2	Altura - 21.64 cm

CORREDIZA 3 HOJAS

RIEL SENCILLO

CLAVE	DESCRIPCIÓN	PIEZAS	DESCUENTO
25407	Cabezal	2	Ancho - 2.6 cm
25407	Cabezal	1	Ancho Real
15408	Jamba Sencilla	2	Altura Real
15407	Riel Sencillo	2	Ancho - 2.6 cm
15407	Riel Sencillo	1	Ancho Real
48409	Cerco Chapa	2	Altura - 2.06 cm
68410	Traslape	4	Altura - 2.06 cm
62263	Cabezal	3	Ancho + 3 + 2.06 cm
68412	Zoclo (Inferior)	3	Ancho + 3 + 2.06 cm

SERIE 80 CRISTAL DOBLE

FIJO CRISTAL DOBLE

CLAVE	DESCRIPCIÓN	PIEZAS	DESCUENTO
22592	Bolsa	1	Ancho - 9.0 cm
22592	Bolsa	2	Altura Real
22593	Escalonado	1	Ancho - 9.0 cm
12507	Junquillo	1	Ancho - 9.0 cm

FIJO TRIPLE CRISTAL DOBLE

CLAVE	DESCRIPCIÓN	PIEZAS	DESCUENTO
13829	Bolsa	1	Ancho - 10.6 cm
13829	Bolsa	2	Altura Real
13830	Escalonado	1	Ancho - 10.6 cm
13832	Junquillo	1	Ancho - 10.6 cm

CORREDIZA

RIEL TRIPLE CRISTAL DOBLE

CLAVE	DESCRIPCIÓN	PIEZAS	DESCUENTO
648407	Riel y Cabezal	2	Ancho - 3.6 cm
668408	Jamba Triple	2	Altura Real
78419	Cerco Chapa	2	Altura - 3.44 cm
38420	Traslape	4	Altura - 3.44 cm
32437	Zoclo y Cabezal	6	Ancho + 3 + 1.8 cm

VENTANA PROYECCIÓN O ABATIBLE SERIE 80

VENTANA PROYECCIÓN O ABATIBLE

CLAVE	DESCRIPCIÓN	PIEZAS	DESCUENTO
74396	Contramarco	2	Ancho Real
74396	Contramarco	2	Altura Real
54395	Marco de Hoja	2	Ancho - 5.22 cm
54395	Marco de Hoja	2	Altura - 5.22 cm
24323	Junquillo	4	Ancho - 20.72 cm
24323	Junquillo	4	Altura - 20.72 cm
22271	Contramarco Mosquitero	2	Ancho Real
22271	Contramarco Mosquitero	2	Altura Real
22270	Marco Mosquitero	2	Ancho - 3.4 cm
22270	Marco Mosquitero	2	Altura - 3.4 cm

PUERTA BATIENTE MULTIDISEÑOS SERIE 80

PUERTA BATIENTE MULTIDISEÑOS

CLAVE	DESCRIPCIÓN	PIEZAS	DESCUENTO
12618	Batiente	1	Ancho Real
12618	Batiente	2	Altura Real
412544	Cerco Chapa	2	Altura - 4.2 cm
412596	Cabezal	1	Ancho - 27.02 cm
412596	Zoclo	1	Ancho - 27.02 cm
19188	Sello de Hermeticidad	2	Ancho - 7.5 cm
24323	Junquillo	4	Ancho - 27.02 cm
24323	Junquillo	4	Altura - 34.6 cm

LÍNEA SERIE 100 HERMÉTICA CRISTAL 6 mm - 9 mm

FIJO - VENTANA Y PUERTA CORREDIZA

FELPA DE 11 mm (F5L)

FIJO

CLAVE	DESCRIPCIÓN	PIEZAS	DESCUENTO
13614	Bolsa	1	Ancho - 10.16 cm
13614	Bolsa	2	Altura Real
13617	Escalonado	1	Ancho - 10.16 cm
13616	Junquillo	1	Ancho - 10.16 cm

FIJO DESCENTRADO

CLAVE	DESCRIPCIÓN	PIEZAS	DESCUENTO
23612	Escalonado Vert	2	Altura Real
23612	Escalonado Hrz	2	Ancho Real
24323	Junquillo	2	Altura - 12.0 cm
24323	Junquillo	2	Ancho - 12.0 cm

VENTANA CORREDIZA RIEL DOBLE

CLAVE	DESCRIPCIÓN	PIEZAS	DESCUENTO
23578	Riel y Cabezal	2	Ancho - 2.56 cm
23579	Jamba	2	Altura Real
93580	Cerco Chapa	2	Altura - 2.4 cm
H84427	Traslape	2	Altura - 2.4 cm
74581	Zoclo y Cabezal	4	Ancho + 2 - 0.08 cm

FIJO DESCENTRADO

CLAVE	DESCRIPCIÓN	PIEZAS	DESCUENTO
23612	Escalonado	2	Altura Real
412596	Cabezal	2	Ancho - 12.0 cm
24323	Junquillo	4	Ancho - 12.0 cm
24323	Junquillo	2	Altura - 30.4 cm

PUERTA CORREDIZA RIEL DOBLE

CLAVE	DESCRIPCIÓN	PIEZAS	DESCUENTO
23578	Riel y Cabezal	2	Ancho - 2.56 cm
23579	Jamba	2	Altura Real
93582	Cerco Chapa	2	Altura - 2.4 cm
H14427	Traslape 5"	2	Altura - 2.4 cm
84581	Zoclo y Cabezal	4	Ancho + 2 + 1.78 cm

LÍNEA SERIE 100 TRIPLE HERMÉTICA CRISTAL 6 mm - 9 mm

FIJO - VENTANA Y PUERTA CORREDIZA

FELPA DE 11 mm (F5L)

VENTANA CORREDIZA RIEL TRIPLE

CLAVE	DESCRIPCIÓN	PIEZAS	DESCUENTO
34715	Riel y Cabezal	2	Ancho - 2.62 cm
33635	Jamba	2	Altura Real
93580	Cerco Chapa	2	Altura - 2.4 cm
H84427	Traslape	4	Altura - 2.4 cm
74581	Zoclo y Cabezal	6	Ancho + 3 + 1.96 cm

PUERTA CORREDIZA RIEL TRIPLE

CLAVE	DESCRIPCIÓN	PIEZAS	DESCUENTO
34715	Riel y Cabezal	2	Ancho - 2.62 cm
33635	Jamba	2	Altura Real
93582	Cerco Chapa	2	Altura - 2.4 cm
H14427	Traslape 5"	4	Altura - 2.4 cm
84581	Zoclo y Cabezal	6	Ancho + 3 + 4.48 cm

PUERTA CORREDIZA RIEL SENCILLO 3 HOJAS

CLAVE	DESCRIPCIÓN	PIEZAS	DESCUENTO
25230	Cabezal	2	Ancho - 2.2 cm
25230	Cabezal	1	Ancho Real
15232	Jamba Sencilla	2	Altura Real
25231 / 15231	Riel Sencillo	2	Ancho - 2.2 cm
25231 / 15231	Riel Sencillo	1	Ancho Real
93582	Cerco Chapa	2	Altura - 2.4 cm
H14427	Traslape 5"	4	Altura - 2.4 cm
84581	Zoclo y Cabezal	6	Ancho + 3 + 4.49 cm
15236	Adaptador Carretilla	3	Ancho + 3 + 4.49 cm

VENTANA CORREDIZA RIEL TRIPLE CON MOSQUITERO

CLAVE	DESCRIPCIÓN	PIEZAS	DESCUENTO
34715	Riel y Cabezal	2	Ancho - 2.62 cm
33635	Jamba	2	Altura Real
93580	Cerco Chapa	4	Altura - 2.4 cm
H84427	Traslape	2	Altura - 2.4 cm
74581	Zoclo y Cabezal	6	Ancho + 2 - 0.11 cm
53639	Adaptador Cerco	2	Altura - 2.4 cm
23642	Tapa Cerco	2	Altura - 2.4 cm
93638	Adaptador Mosquitero	2	Ancho + 2 - 14.86 cm
93638	Adaptador Mosquitero	2	Altura - 20.26 cm

PUERTA CORREDIZA RIEL TRIPLE CON MOSQUITERO

CLAVE	DESCRIPCIÓN	PIEZAS	DESCUENTO
34715	Riel y Cabezal	2	Ancho - 2.62 cm
33635	Jamba	2	Altura Real
93582	Cerco Chapa	4	Altura - 2.4 cm
H14427	Traslape 5"	2	Altura - 2.4 cm
84581	Zoclo y Cabezal	6	Ancho + 2 + 1.76 cm
53639	Adaptador Cerco	2	Altura - 2.4 cm
23642	Tapa Cerco	2	Altura - 2.4 cm
93638	Adaptador Mosquitero	2	Ancho + 2 - 20.61 cm
93638	Adaptador Mosquitero	2	Altura - 27.8 cm

LÍNEA SERIE 100 TRIPLE HERMÉTICA CRISTAL DOBLE FIJO - VENTANA Y PUERTA CORREDIZA FELPA DE 11 mm (F5L)

FIJO CRISTAL DOBLE

CLAVE	DESCRIPCIÓN	PIEZAS	DESCUENTO
13829	Bolsa	1	Ancho - 10.16 cm
13829	Bolsa	2	Altura Real
13830	Escalonado	1	Ancho - 10.16 cm
13832	Junquillo	1	Ancho - 10.16 cm

VENTANA CORREDIZA

RIEL DOBLE CRISTAL DOBLE

CLAVE	DESCRIPCIÓN	PIEZAS	DESCUENTO
23578	Riel y Cabezal	2	Ancho - 2.56 cm
23579	Jamba	2	Altura Real
74083	Cerco Chapa	2	Altura - 2.4 cm
58792	Traslape	2	Altura - 2.4 cm
54082	Zoclo y Cabezal	4	Ancho + 2 - 0.13 cm

PUERTA CORREDIZA

RIEL DOBLE CRISTAL DOBLE

CLAVE	DESCRIPCIÓN	PIEZAS	DESCUENTO
23578	Riel y Cabezal	2	Ancho - 2.56 cm
23579	Jamba	2	Altura Real
64083	Cerco Chapa	2	Altura - 2.4 cm
68792	Traslape 5"	2	Altura - 2.4 cm
34082	Zoclo y Cabezal	4	Ancho + 2 + 1.79 cm

VENTANA PROYECCIÓN O ABATIBLE SERIE 100

VENTANA DE PROYECCIÓN Ó ABATIBLE

CLAVE	DESCRIPCIÓN	PIEZAS	DESCUENTO
13396	Contramarco	2	Ancho Real
13396	Contramarco	2	Altura Real
54395	Marco de Hoja	2	Altura - 5.22 cm
54395	Marco de Hoja	2	Altura - 5.22 cm
24323	Junquillo	4	Ancho - 20.72 cm
24323	Junquillo	4	Altura - 20.72 cm

VENTANA DE PROYECCIÓN Ó ABATIBLE

MOSQUITERO MULTILINEA

CLAVE	DESCRIPCIÓN	PIEZAS	DESCUENTO
13396	Contramarco	2	Ancho Real
13396	Contramarco	2	Altura Real
54395	Marco de Hoja	2	Ancho - 5.22 cm
54395	Marco de Hoja	2	Altura - 5.22 cm
24323	Junquillo	4	Ancho - 20.72 cm
24323	Junquillo	4	Altura - 20.72 cm
22271	Contramarco Mosquitero	2	Ancho Real
22271	Contramarco Mosquitero	2	Altura Real
22270	Marco Mosquitero	2	Ancho - 3.4 cm
22270	Marco Mosquitero	2	Altura - 3.4 cm

PUERTA BATIENTE MULTIDISEÑOS

PUERTA BATIENTE MULTIDISEÑOS

CLAVE	DESCRIPCIÓN	PIEZAS	DESCUENTO
9242	Batiente Colonial	1	Ancho Real
9242	Batiente Colonial	2	Altura Real
412545	Cerco Chapa	2	Altura - 4.98 cm
412599	Cabezal, Intermedio y Zoclo	2	Ancho - 43.82 cm
19188	Sello de Hermeticidad	2	Ancho - 9.06 cm
24323	Junquillo	4	Ancho - 43.82 cm
24323	Junquillo	4	Altura - 55.78 cm

PUERTA BATIENTE MULTIDISEÑOS

CLAVE	DESCRIPCIÓN	PIEZAS	DESCUENTO
9243	Batiente Colonial	1	Ancho Real
9243	Batiente Colonial	2	Altura Real
412545	Cerco Chapa	2	Altura - 6.82 cm
412599	Cabezal, Intermedio y Zoclo	2	Ancho - 47.5 cm
19188	Sello de Hermeticidad	2	Ancho - 12.74 cm
24323	Junquillo	4	Ancho - 47.5 cm
24323	Junquillo	4	Altura - 57.62 cm

LÍNEA SERIE 35

FIJO - VENTANA BATIENTE "O" PROYECCIÓN

FIJO

CLAVE	DESCRIPCIÓN	PIEZAS	DESCUENTO
12606	Bolsa	1	Ancho - 9.0 cm
12606	Bolsa	2	Altura Real
12608	Escalonado	1	Ancho - 9.0 cm
12609	Junquillo	1	Ancho - 9.0 cm

VENTANA DE PROYECCIÓN Ó ABATIBLE

VINIL INTERIOR

CLAVE	DESCRIPCIÓN	PIEZAS	DESCUENTO
42273	Contramarco	2	Ancho Real
42273	Contramarco	2	Altura Real
42276	Marco	2	Ancho - 4.9 cm
42276	Marco	2	Altura - 4.9 cm

VENTANA DE PROYECCIÓN Ó ABATIBLE

MOSQUITERO MULTI-LÍNEA

CLAVE	DESCRIPCIÓN	PIEZAS	DESCUENTO
42273	Contramarco	2	Ancho Real
42273	Contramarco	2	Altura Real
32274	Marco	2	Ancho - 4.9 cm
32274	Marco	2	Altura - 4.9 cm
22271	Contramarco	2	Ancho Real
22271	Contramarco	2	Altura Real
22270	Marco Mosq.	2	Ancho - 3.4 cm
22270	Marco Mosq.	2	Altura - 3.4 cm

LÍNEA SERIE 35

CRISTAL DOBLE

FIJO

CRISTAL DOBLE

CLAVE	DESCRIPCIÓN	PIEZAS	DESCUENTO
12613	Bolsa	1	Ancho - 9.0 cm
12613	Bolsa	2	Altura Real
12614	Escalonado	1	Ancho - 9.0 cm
12603	Junquillo	1	Ancho - 9.0 cm

VENTANA DE PROYECCIÓN Ó ABATIBLE

CRISTAL DOBLE

CLAVE	DESCRIPCIÓN	PIEZAS	DESCUENTO
42273	Contramarco	2	Ancho Real
42273	Contramarco	2	Altura Real
22277	Marco	2	Ancho - 4.9 cm
22277	Marco	2	Altura - 4.9 cm

LÍNEA SERIE 50 FIJO - VENTANA BATIENTE "O" PROYECCIÓN

FIJO

CLAVE	DESCRIPCIÓN	PIEZAS	DESCUENTO
12504	Bolsa	1	Ancho - 9.0 cm
12504	Bolsa	2	Altura Real
12506	Escalonado	1	Ancho - 9.0 cm
12507	Junquillo	1	Ancho - 9.0 cm

FIJO CRISTAL DOBLE

CLAVE	DESCRIPCIÓN	PIEZAS	DESCUENTO
12592	Bolsa	1	Ancho - 9.0 cm
12592	Bolsa	2	Altura Real
12593	Escalonado	1	Ancho - 9.0 cm
12543	Junquillo	1	Ancho - 9.0 cm

VENTANA DE PROYECCIÓN Ó ABATIBLE

CLAVE	DESCRIPCIÓN	PIEZAS	DESCUENTO
54396	Contramarco	2	Ancho Real
54396	Contramarco	2	Altura Real
54395	Marco de Hoja	2	Ancho - 4.98 cm
54395	Marco de Hoja	2	Altura - 4.98 cm
24323	Junquillo	4	Ancho - 20.48 cm
24323	Junquillo	4	Altura - 20.48 cm

MONUMENTAL

PUERTA MONUMENTAL

CLAVE	DESCRIPCIÓN	PIEZAS	DESCUENTO
12530/8243	Canal Vert.	2	Altura Real
12530/8243	Canal Horiz.	1	Ancho Real.
412545	Cerco Chapa	2	Altura - 7.2 cm.
19187	Zoclo Cabezal	2	Ancho - 32.8 cm.
14321	Adaptador Cerco Chapa	2	Altura - 6.9 cm.
29188	Sello Herm. Inferior	1	Ancho - 11.9 cm.
39188	Sello Herm. Superior	1	Ancho - 11.9 cm.
5567	Tapa Guardapolvo	2	Ancho - 11.9 cm.

PUERTA MONUMENTAL

CLAVE	DESCRIPCIÓN	PIEZAS	DESCUENTO
29243	Batiente Vert. corte 45°	2	Altura Real
29243	Batiente Horiz. corte 45°	1	Ancho Real.
412540	Cerco Chapa	2	Altura - 6.8 cm.
9187	Zoclo Cabezal	2	Ancho - 29.2 cm.
14321	Adaptador Cerco Chapa	2	Altura - 6.5 cm.
29188	Sello Herm. Inferior	1	Ancho - 11.7 cm.
39188	Sello Herm. Superior	1	Ancho - 11.7 cm.
5567	Tapa Guardapolvo	1	Ancho - 11.7 cm.
5567	Tapa Guardapolvo	1	Ancho - 15.7 cm.

LÍNEA FIJA, PROYECCIÓN Y ABATIBLE 1400

LÍNEA 1400 BATIENTE Y PROYECCIÓN

CLAVE	DESCRIPCIÓN	PIEZAS	DESCUENTO
41402	Cerco Vent. Vert.	2	Altura Real
41402	Cerco Vent. Horiz.	2	Ancho Real.
41401	Hoja Vent. Vert.	2	Altura - 3.7 cm.
41401	Hoja Vent. Horiz.	2	Ancho - 3.7 cm.
41430/41433	Junquillo (45°) Vert.	2	Altura - 11.7 cm.
41430/41433	Junquillo (45°) Horiz.	2	Ancho - 11.7 cm.

MOSQUITERO ENROLLABLE CORREDIZO, GUILLOTINA CON CADENA

VENTANA GUILLOTINA CON CADENA

CLAVE	DESCRIPCIÓN	PIEZAS	DESCUENTO
20010	Cajón	1	Ancho - 2.8 cm.
20008	Jamba Mosq.	1	Ancho Real
20007	Jaladera Ventana	1	Altura - 2.8 cm.
20006	Guía c/tela	1	Ancho - 2.8 cm.
20009	Riel p/mosq.	2	Altura - 5.8 cm.
20012	Tapa Felpas	1	Ancho - 2.8 cm.

VENTANA CORREDIZA

CLAVE	DESCRIPCIÓN	PIEZAS	DESCUENTO
20010	Cajón	1	Altura - 2.8 cm.
20008	Jamba Mosq.	1	Altura Real
20007	Jaladera Ventana	1	Altura - 2.8 cm.
20006	Guía c/Tela	1	Altura - 2.8 cm.
20009	Riel p/Mosq.	2	Ancho - 5.8 cm.
20012	Tapa Felpas	1	Altura - 2.8 cm.

CANCELES DE BAÑO

CANCEL DE BAÑO COMERCIAL

CLAVE	DESCRIPCIÓN	PIEZAS	DESCUENTO
4079	Riel Superior	1	Ancho Real
4332	Guía inferior	1	Ancho - 0.5 cm
4331	Jamba	2	Altura - 2.5 cm
4334	Marco Horiz.	4	Ancho - 6.4 cm ÷ 2
11035	Marco Vert.	4	Altura - 5.3 cm

CANCEL DE BAÑO EN ESCUADRA

CLAVE	DESCRIPCIÓN	PIEZAS	DESCUENTO
4079	Riel Superior	1	Ancho - 0.2 cm.
4332	Guía inferior	1	Ancho - 0.5 cm.
4331	Jamba	1	Altura - 3.8 cm.
11035	Marco Vert.	4	Altura - 6.2 cm.
11047	Esquinero	1	Altura Real.
11049	Marco Vert. a Muro	1	Altura Real.
11042	Marco Horiz.	2	Ancho - 5.5 cm.

PUERTA GUILLOTINA CON CADENA

CLAVE	DESCRIPCIÓN	PIEZAS	DESCUENTO
20011	Cajón	1	Ancho - 2.8 cm.
20008	Jamba Mosq.	1	Ancho Real.
20003	Jaladera Puerta	1	Ancho - 2.8 cm.
20006	Guía c/Tela	1	Ancho - 3.2 cm.
20009	Riel p/Mosq.	2	Altura - 6.7 cm.
20012	Tapa Felpas	1	Ancho - 2.8 cm.

PUERTA CORREDIZA

CLAVE	DESCRIPCIÓN	PIEZAS	DESCUENTO
20011	Cajón Black Out	1	Altura - 2.8 cm.
20008	Jamba Mosq.	1	Altura Real.
20009	Riel Mosq.	2	Ancho - 6.7 cm.
20006	Guía con Tela	1	Altura - 3.2 cm.
20003	Jaladera Puerta	1	Altura - 2.8 cm.
20012	Tapa Felpas	1	Ancho - 2.8 cm.

El Marco se Arma a 45°

CANCEL DE BAÑO DE LUJO

CLAVE	DESCRIPCIÓN	PIEZAS	DESCUENTO
9947	Riel Superior	1	Ancho Real.
10198	Guía inferior	1	Ancho - 0.6 cm.
10197	Jamba	2	Altura - 2.8 cm.
6854	Marco Horiz.	4	Ancho ÷2 + 2.5 cm.
6854	Marco Vert.	4	Altura - 5.0 cm.

CANCEL DE BAÑO CRISTAL TEMPLADO

CLAVE	DESCRIPCIÓN	PIEZAS	DESCUENTO
10020	Riel Superior	1	Ancho Real
	Cristal (HM)	2	Altura - 7 cm.
	Cristal (HM)	2	Ancho ÷2+2.5 cm.

Cristal Templado

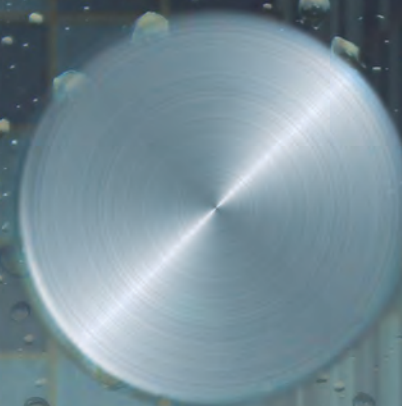

ÍNDICE ALFABÉTICO

H E R R A J E S C R I S T A L T E M P L A D O

A	ACCESORIOS DE SEGURIDAD	179	CH	CHAPAS	166	S	SEPARADORES	176
	ARAÑA ACERO INOXIDABLE	166		D	DETALLADO EN CRISTALES		179	PARA CRISTAL DOBLE
B	BISAGRAS HIDRÁULICAS	163	E		ESPACIADOR JALADERA		167	SOPORTES
	BISAGRAS	166		ESPEJO CONVEXO	179	SOPORTES PASAMANOS	172	
	CRISTAL A CRISTAL - MURO CRISTAL			ESTANTERÍA COLGANTE	176	SOPORTE DE ESPEJO	179	
C	CLIPS Y CLIPOS	171	H	HERRAMIENTAS PARA CRISTAL	179	T	TAPAS PASAMANOS	172
	CALZAS DE NEOPRENO	177		J	JALADERAS ACERO INOXIDABLE		173	TAPAS ZOCLO HERCULITE
	CALZAS ZOCLO HERCULITE	165	JALADERAS PERILLA DOBLE		167		TUBOS PASAMANOS	172
	CANCEL DE BAÑO	170	JALADERA TOALLERO		170	V	VENTOSAS	179
	CINTAS	177	P	PASAMANOS	172			
	CONECTORES	168		PELÍCULA ADHERIBLE	178			
	CORTA VIDRIOS	178		PERFILES POLICARBONATO	167			
CINTAS CRISTAL DOBLE	177	PIVOTES		165				
CUADRÍCULA INTERNA	176	PIVOTANTE		166				
			POSTES ACERO INOX.	172				

CLAVE / PAG.	CLAVE / PAG.	CLAVE / PAG.	CLAVE / PAG.	CLAVE / PAG.	CLAVE / PAG.	CLAVE / PAG.	CLAVE / PAG.	CLAVE / PAG.	CLAVE / PAG.										
27E	176	1019R	177	1561C	168	2031C	167	2338	177	2720G	174	3032	171	3142	172	EP	172	PTPRG	178
27EC	176	1031	166	1639	178	2031G	167	2345	164	2728	174	3032C	171	3142C	172	H1110	168	SP	172
27EG	176	1031C	166	1640	177	2033	174	2400	173	2735	177	3032G	171	3142G	172	H1111	168	SPM	172
28E	176	1031G	166	1641	176	2043	172	2420	179	2735R	177	3033	169	3142P	172	H1307	169	SPN	172
28EC	176	1032	164	1641C	176	2043C	172	2421	179	2766	176	3033C	169	3142PC	172	H1308	169	SPN1	172
28EG	176	1105	177	1641G	176	2043G	172	2422	173	2780	177	3033G	169	3142PG	172	H1309	169	TJL	175
243	179	1105R	177	1648	178	2044	179	2453	177	2780C	177	3034	171	3145	168	J115	174	TP2	172
272	179	1107	178	1767	171	2091	177	2453R	177	2780G	177	3034C	171	3155	171	J117	174	TP2C	172
301	177	1108	178	1767C	171	2097	168	2454	177	2797	179	3034G	171	3155C	171	J127	173	TP2G	172
302	177	1115	172	1767G	171	2097C	168	2454R	177	2837	177	3035	171	3155G	171	J178	173	TP3	172
302C	177	1115C	172	1796	179	2097G	168	2458	179	2837C	177	3035C	171	3167	163	J208	174	TP3C	172
302G	177	1115G	172	1819	167	2098	168	2459	179	2837G	177	3035G	171	3167C	163	J213-30	173	TP3G	172
303	177	1140	167	1821	167	2098C	168	2461	171	2843	166	3036	169	3167G	163	J213-45	173	TP4	172
303C	177	1140C	167	1821C	167	2098G	168	2461C	171	2850	166	3036C	169	3168	178	J213-60	173	TP4C	172
303G	177	1140G	167	1821G	167	2123	174	2461G	171	2861	173	3036G	169	3260	171	J228	170	TP4G	172
321	179	1151	174	1822	178	2125	169	2462	171	2873	173	3036H	169	3260C	171	J228C	170	TPP	172
323	179	1154	171	1828	178	2125C	169	2462C	171	2874	173	3036HC	169	3260G	171	J228G	170	TPPC	172
356K	164	1160	171	1877	176	2125CC	169	2462G	171	2875	166	3036HG	169	3264	179	J230	174	TPPG	172
360	168	1160C	171	1877C	176	2125CG	169	2488	168	2875C	166	3057	173	C6C12	170	J232	174	TRJ	173
422	178	1160G	171	1877G	176	2125CH	169	2488C	168	2875G	166	3064	168	C6C12R	170	JCT6	170	TRJ	174
424	179	1160P	171	1879	176	2125G	169	2517	168	2877	171	3064C	168	C6C15	170	JCT6C	170	TZH	165
444	178	1160PC	171	1879C	176	2125M	169	2518	177	2877C	171	3064G	168	C6C15R	170	JCT6G	170	TZHC	165
504A	166	1160PG	171	1879G	176	2125MC	169	2519	177	2877G	171	3066	172	C6C20	170	JCT6R	170	TZHG	165
541	177	1190	169	1897	178	2125MG	169	2523	168	2878	166	3066C	172	C6C20R	170	JCT6RC	170	TZP	165
541R	177	1190-6	167	1906K	164	2131	178	2524	166	2903	173	3066G	172	C9C12	170	JCT6RG	170	TZPC	165
633	177	1190-9	167	1926	167	2136	179	2567	165	2928	178	3066P	172	C9C12R	170	JCT9	170	TZPG	165
633R	177	1190C	169	1926C	167	2160	171	2599	168	2928R	178	3066PC	172	C9C15	170	JCT9C	170	VENT3	179
646	177	1190G	169	1926G	167	2160C	171	2599C	168	2928RG	178	3066PG	172	C9C15R	170	JCT9G	170	VENT3C	179
671	172	1333	179	1992	167	2160G	171	2599G	168	2941	166	3073	169	C9C20	170	JCT9R	170	VENT3G	179
671C	172	1391	177	1997	178	2241	169	2637	178	2943	175	3073C	169	C9C20R	170	JCT9RC	170	VG5	179
671G	172	1442	174	1997R	178	2241C	169	2637R	178	2945	173	3073G	169	CB120	170	JCT9RG	170	VG5C	179
687	176	1450	178	1997RG	178	2241G	169	2637RG	178	2952	176	3075P	168	CB150	170	JE	178	VG5G	179
687C	176	1452	178	1999C	163	2273	176	2638	176	2962	179	3075PC	168	CB200	170	JEC	178	VG7	179
687G	176	1454	177	1999CC	163	2275	168	2639	176	2964	178	3075PG	168	CCP	172	JEG	178	VG7C	179
832	179	1454R	177	1999CG	163	2276	164	2656	177	2964R	178	3078	172	CG10	165	PCAA	168	VG7G	179
853	178	1476	174	2000P	163	2277	168	2656R	177	2964RG	178	3078C	172	CG10C	165	PDAC	168		
871	167	1477	179	2000PC	163	2278	173	2664P	168	2968	167	3078G	172	CG10G	165	PG	163		
893	179	1478	179	2000PG	163	2293	179	2664PC	168	2968C	167	3087	178	CG12	165	PGC	163		
912	177	1481	179	2006	165	2296	179	2664PG	168	2968G	167	3087R	178	CG12C	165	PGG	163		
912R	177	1481M	179	2015	179	2315	179	2665	175	2979	166	3105	174	CG12G	165	Pi	163		
912B	177	1525	176	2022	173	2319	176	2688	171	3024	167	3106	177	CMC	169	PiC	163		
912BR	177	1526	176	2023	173	2319C	176	2688C	171	3029	169	3109	171	CN12	177	PiG	163		
925	178	1526R	176	2025	171	2319G	176	2688G	171	3029C	169	3109C	171	CN12M	177	PS	163		
932	165	1527	176	2025C	171	2320	176	2689P	171	3029G	169	3109G	171	CN12P	177	PS220	178		
943	164	1528	176	2025G	171	2320C	176	2689PC	171	3030	169	3126	175	CN38	177	PS220R	178		
944	164	1529	176	2029	174	2320G	176	2689PG	171	3030C	169	3127	175	CN38M	177	PS220RG	178		
988	166	1530	176	2030	167	2322	178	2697	173	3030G	169	3133	172	CN38P	177	PSC	163		
988C	166	1540	164	2030C	167	2322R	178	2719	174	3031	169	3134	172	CN78	177	PSG	163		
988G	166	1559	179	2030G	167	2322RG	178	2720	174	3031C	169	3135	172	CN78M	177	PTP	178		
989	175	1561	168	2031	167	2333	176	2720C	174	3031G	169	3136	172	CN78P	177	PTPR	178		

BISAGRAS HIDRÁULICAS CRISTAL TEMPLADO



1999C Juego
1999CC 4 Juegos
1999CG 8 Juegos

Características :

- Control de Cierre de 2 velocidades
- Recibe Cristal 9 - 12 mm
- Capacidad: 150 kg

Incluye:

- Bisagra Hidráulica
- Pivote Superior
- Pivote Inferior
- Chapa
- Punto de Giro
- Llaves
- Contra

1,250,000 Ciclos con 55 Kg
1,000,000 Ciclos con 70 Kg

Probada en Nuestro Centro de Investigación y Desarrollo Cristal 12 mm

PIEZAS REEMPLAZO BISAGRA 1999C

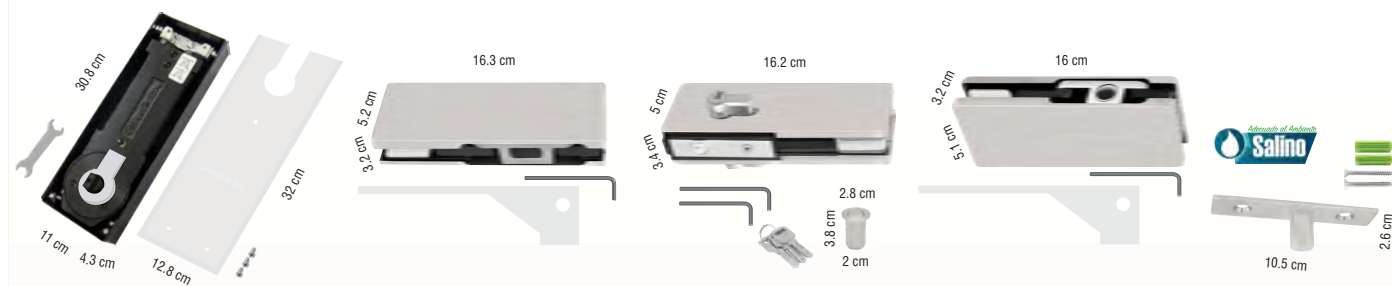

BISAGRA HIDRÁULICA
1,350,000 Ciclos con 35 Kg
Capacidad 150 Kg

2000P Pieza
2000PC 4 Piezas
2000PG 8 Piezas

PIVOTE INFERIOR

■ Satín
Pi Pieza
PiC 4 Piezas
PiG 8 Piezas

CHAPA

■ Satín
3167 Pieza
3167C 4 Piezas
3167G 8 Piezas

PIVOTE SUPERIOR

■ Satín
PS Pieza
PSC 4 Piezas
PSG 8 Piezas

PUNTO DE GIRO

■ Satín
PG Pieza
PGC 4 Piezas
PGG 8 Piezas



RESAQUES AL CRISTAL

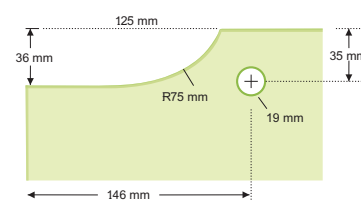

Resaque Pivote Superior

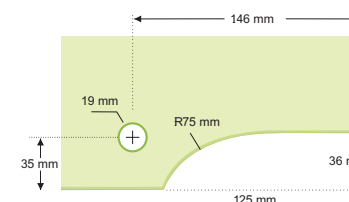

Resaque Chapa

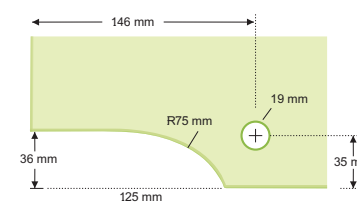

Resaque Pivote Inferior

El juego de Bisagra Incluye: Bisagra Hidráulica, Pivote Superior, Pivote Inferior, Chapa, Punto de Giro, Llaves y Contra

Probadas en Nuestro Centro de Investigación y Desarrollo **Cristal 12 mm**

BISAGRA HIDRÁULICA

PIEZAS REEMPLAZO 356K y 1906K

BISAGRA HIDRÁULICA



356K

Mod. S202N
Cristal 9 - 12 mm

Satin

Capacidad 130 Kg
700,000 Ciclos con 50 kg



1032

Punto de Giro

Satin

RESAQUES AL CRISTAL

Pivote Superior, inferior y Chapa

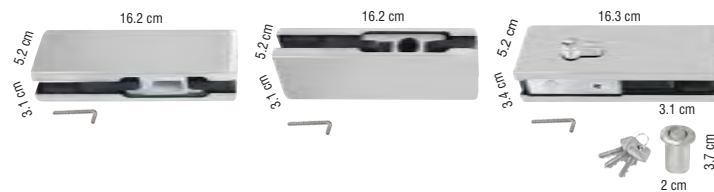
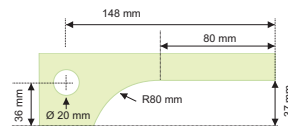

943

Inferior

Satin Cromo

944

Superior

Satin Cromo

2276

Chapa

Satin Cromo

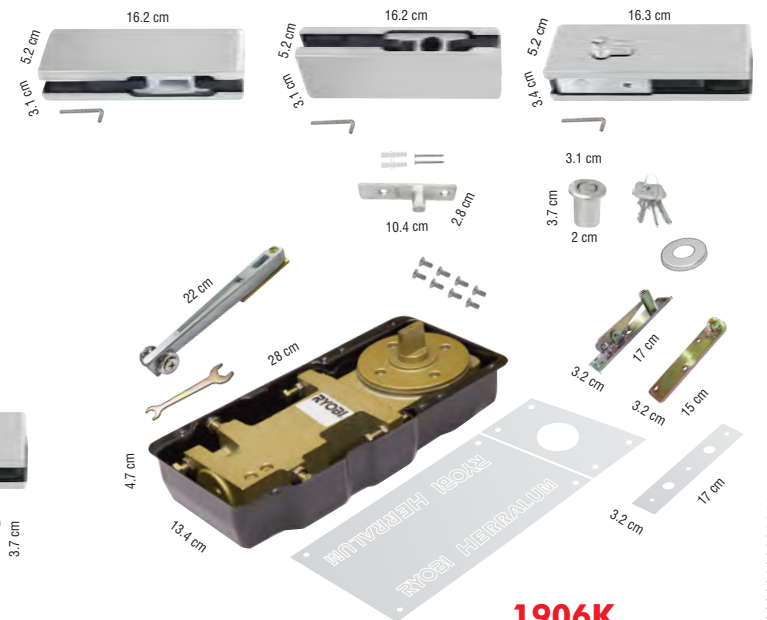

1906K

Mod. S203N

Cristal 9 - 12 mm

Satin

Capacidad 180 Kg
1,050,000 Ciclos con 50 kg

BISAGRA HIDRÁULICA DORMA

PIEZA REEMPLAZO DORMA



2345

Dorma BTS-75R
Cristal 9 - 12 mm

Satin

Capacidad 120 Kg
2,200,000 Ciclos con 50 kg

RESAQUE AL CRISTAL

Pivote Superior, inferior y Chapa

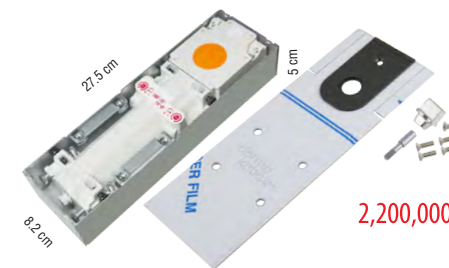

1540

Dorma BTS-75R
Capacidad 120 Kg

2,200,000 Ciclos con 50 kg



TAPAS ZOCLO HERCULITE 8300, 8326 y 8327



TZP Juego
TZPC 10 Juegos
TZPG 20 Juegos

Perfil 8300

Juego Incluye:
 2 Tapas Superiores
 2 Tapas Inferiores
 4 Pijas 8 x 1/2 C.F.



TZH Juego
TZHC 10 Juegos
TZHG 20 Juegos

Perfiles 8326 - 8327

Juego Incluye:
 2 Tapas Superiores
 2 Tapas Inferiores



CALZAS DE POLIESTIRENO

ZOCLOS HERCULITE 8300, 8326 Y 8327

CRISTAL 10 mm

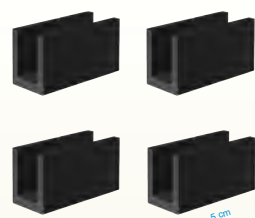

NUEVO



CG10 Juego
CG10C 50 Juegos
CG10G 100 Juegos

Juego Incluye:
 2 Calzas Superiores
 2 Calzas Inferiores

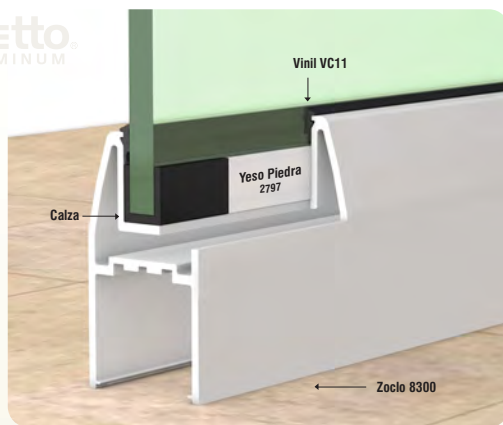

Facilita la Colocación del Cristal con la Retención del Yeso Piedra por Ambos Lados

CRISTAL 12 mm

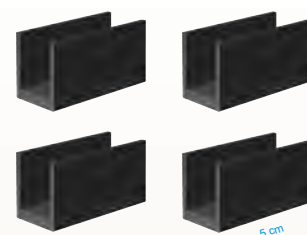

NUEVO



CG12 Juego
CG12C 50 Juegos
CG12G 100 Juegos

Juego Incluye:
 2 Calzas Superiores
 2 Calzas Inferiores

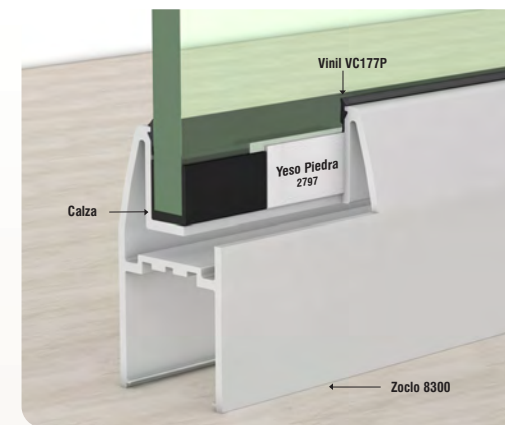

Facilita la Colocación del Cristal con la Retención del Yeso Piedra por Ambos Lados

Cristal Fijo Herraje 2567

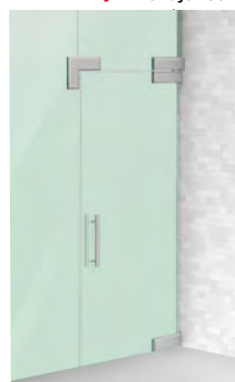

PIVOTES

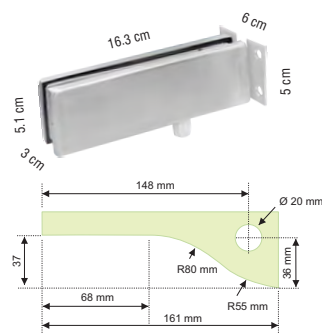

2567

Pivote Superior Fijo a Muro

9 - 12 mm



RESAQUE AL CRISTAL



932

Superior "L"
 9 - 12 mm



RESAQUE AL CRISTAL

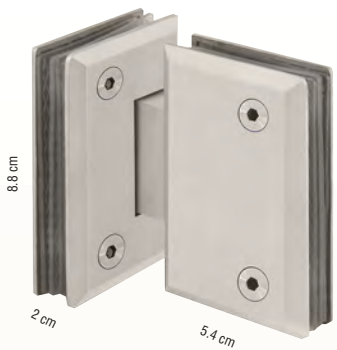

- 988** Pieza Cromo
- 988C** 4 Piezas Cromo
- 988G** 8 Piezas Satín

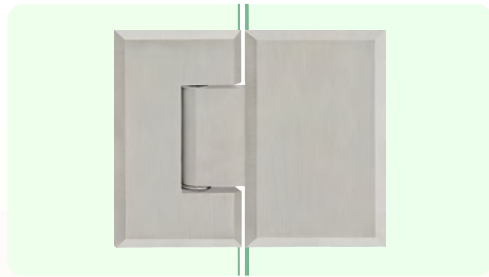

CRISTAL A CRISTAL

Apertura 180°
Acero Inoxidable 304
Cristal 9 - 12 mm

RESAQUE AL CRISTAL

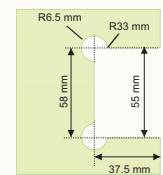

- 1031** Pieza Cromo
- 1031C** 4 Piezas Cromo
- 1031G** 8 Piezas Satín



MURO A CRISTAL

Apertura 180°
Acero Inoxidable 304
Cristal 9 - 12 mm

RESAQUE AL CRISTAL

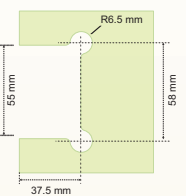

CRISTAL A CRISTAL

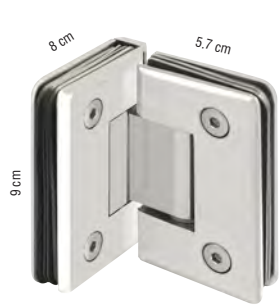

- 2524**
- Apertura 90°
- Cristal 9 a 12 mm



RESAQUE AL CRISTAL

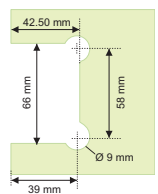

MURO A CRISTAL

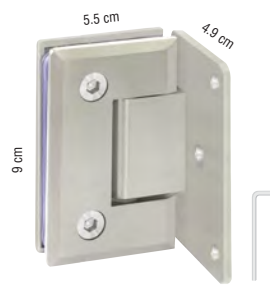

- 2941**
- Desfasada
- Apertura 90°
- Cristal 9 a 12 mm



RESAQUE AL CRISTAL

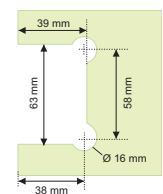

PIVOTANTE

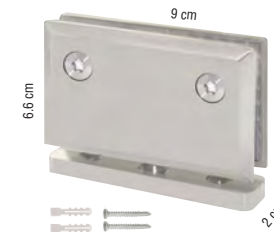

- 2878**
- Tope a 90°
- Cristal 9 a 12 mm
- Cromo
- Satín



RESAQUE AL CRISTAL

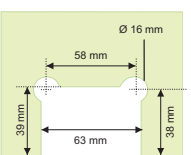

CHAPAS Sin Resaque al Cristal

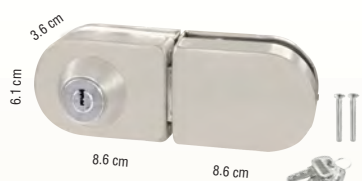

- 2875** Pieza
- 2875C** 10 Piezas
- 2875G** 20 Piezas
- Satín



Recta con Contra al Cristal 6 - 9 mm



- 2979**
- Gancho con
- Contra al Cristal
- 6 - 9 mm
- Satín

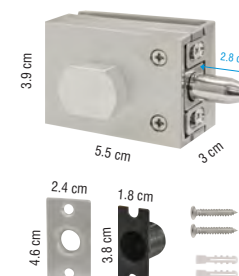

- 504A**
- Chapa con Contra al Muro
- Cristal 6 - 9 mm
- Satín

PERFILES DE POLICARBONATO



Cristal 6 mm



2968 Pieza
2968C 30 Piezas
2968G 60 Piezas

2030 Pieza
2030C 30 Piezas
2030G 60 Piezas

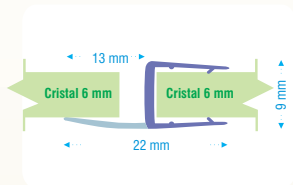

Aleta Lateral Flexible
 Longitud 2.50 m

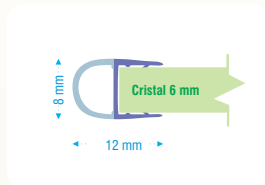

Burbuja Flexible
 Longitud 2.50 m



Cristal 9 mm



1140 Pieza
1140C 30 Piezas
1140G 60 Piezas

1926 Pieza
1926C 30 Piezas
1926G 60 Piezas



2031 Pieza
2031C 30 Piezas
2031G 60 Piezas

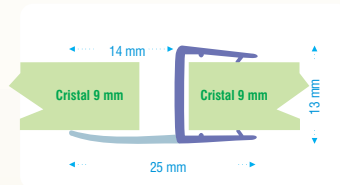

Aleta Lateral Flexible
 Longitud 2.50 m.

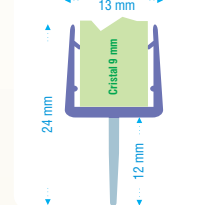

Aleta Central Flexible
 Longitud 2.50 m.

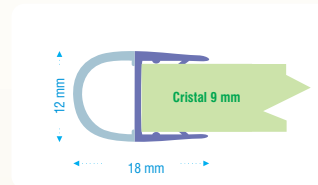

Burbuja Flexible
 Longitud 2.50 m.

Cristal 9 mm

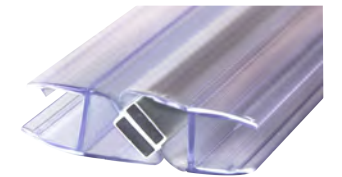

1992
 Par

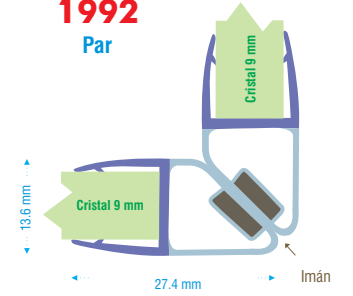

Burbuja Flexible con Imán
 Longitud 2.50 m.

JALADERAS PERILLA DOBLE



1821 Pieza
1821C 20 Piezas
1821G 40 Piezas



Pintable en Nuestros Acabados
 Cristal 6 - 18 mm

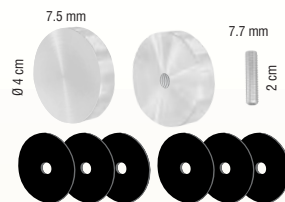
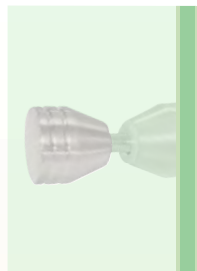

1190-6
 Pieza Cristal 6 mm

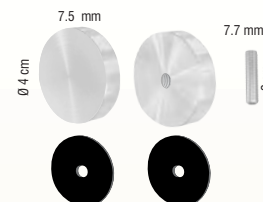

1190-9
 Pieza Cristal 9 mm

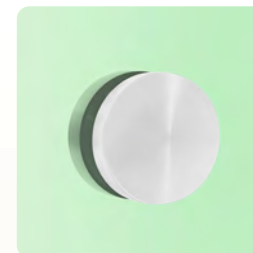

Perforación al Cristal 3/8"
 Pintables en Nuestros Acabados



1819
 6 - 12 mm Satin Cromo
 Perforación al Cristal 1/2"

ESPACIADOR JALADERA



3024
 Par
 Cromo

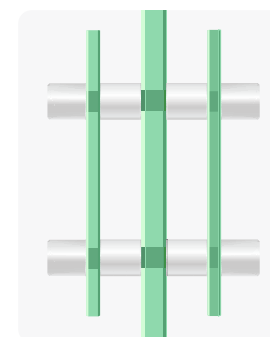



MURO A CRISTAL Acero Inoxidable 304



3075P Pieza
3075PC 4 Piezas
3075PG 8 Piezas

Cristal 9 - 12 mm

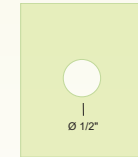

PERFORACIÓN AL CRISTAL



2664P Pieza
2664PC 10 Piezas
2664PG 20 Piezas

Cristal 9 - 12 mm



PERFORACIÓN AL CRISTAL

ACCIÓN VERTICAL



H1110
Pipeta Ajustable
Cristal 6-9 mm



H1111
Pipeta Ajustable
Cristal 6-9 mm

ACCIÓN HORIZONTAL



PCAA
Pipeta Ajustable
Cristal 6-9 mm

ACCIÓN VERTICAL y HORIZONTAL



PDAC
Pipeta Doble Ajuste
Cristal 6-9 mm



2523
Pipeta Morelos 8-12 mm
Perforación al Cristal de 21 mm
Avellanado 31 mm a 45°

Satin



3145
Llave Ajustable
Ajusta Conector:
2664P
H1110



2275
Brazo Estabilizador
Cristal 6-9 mm

Satin

CONECTORES MURO A CRISTAL



2097 Pieza
2097C 10 Piezas
2097G 20 Piezas
Cristal 6 - 12 mm Acero Inoxidable

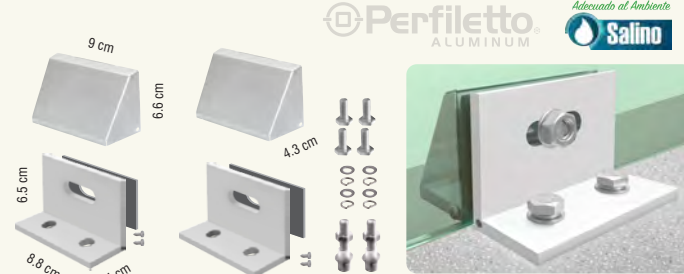

3064 Juego
3064C 4 Juegos
3064G 8 Juegos
Natural Mate



Cristal 9 - 12 mm Juego Aluminio



NUEVO



2098 Pieza
2098C 20 Piezas
2098G 40 Piezas
Curvo con Base 6 - 10 mm

Satin

NUEVO



2599 Pieza
2599C 20 Piezas
2599G 40 Piezas
Recto 6 - 10 mm

Satin

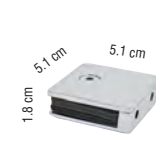

1561C
Recto
6 - 12 mm

Satin

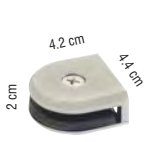

1561
Curvo
6 - 12 mm

Cromo Satin

CONECTORES CRISTAL A CRISTAL

Perforación al Cristal Ø 1/2"



2517
Cuadrado 90°
9 - 12 mm

Satin



2488
Recto 180°
9 - 12 mm

Satin



2488C
Curvo 180°
9 - 12 mm

Cromo Satin



2277
Curvo 90°
9 - 12 mm

Cromo Satin



360
9 - 12 mm

Satin



SOPORTES HUECOS
Perforación al Cristal Ø 1/2"



SOPORTES SÓLIDOS
Perforación al Cristal Ø 1/2"

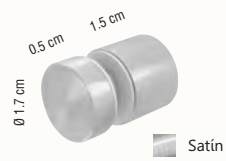

Cristal de 6 - 12 mm
3029 Pieza
3029C 20 Piezas
3029G 40 Piezas

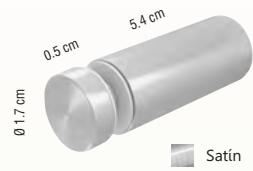

Cristal de 6 - 12 mm
3031 Pieza
3031C 20 Piezas
3031G 40 Piezas

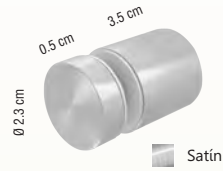

Cristal de 6 - 12 mm
3030 Pieza
3030C 20 Piezas
3030G 40 Piezas



Cristal de 6 - 12 mm
3033 Pieza
3033C 20 Piezas
3033G 40 Piezas



Cristal de 6 - 12 mm
3036H Pieza
3036HC 20 Piezas
3036HG 40 Piezas



Cristal de 6 - 12 mm
3073 Pieza
3073C 20 Piezas
3073G 40 Piezas



Cristal de 6 - 12 mm
2125C Pieza
2125CC 20 Piezas
2125CG 40 Piezas



Cristal de 6 - 12 mm
2125M Pieza
2125MC 20 Piezas
2125MG 40 Piezas



Cristal de 6 - 12 mm
2125 Pieza
2125CH 20 Piezas
2125G 40 Piezas



1190 Pieza
1190C 20 Piezas
1190G 40 Piezas

SOPORTES SÓLIDOS

Perforación al Cristal Ø 1/2"

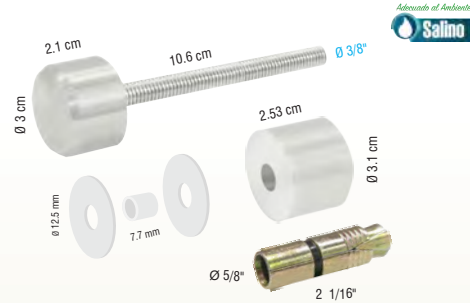

H1307 Pieza
Cristal de 6 - 19 mm

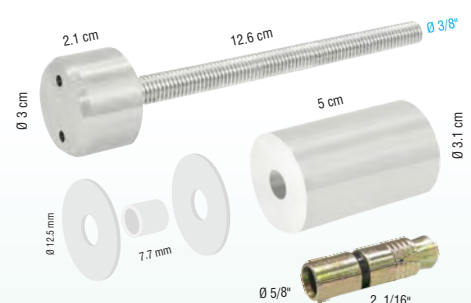
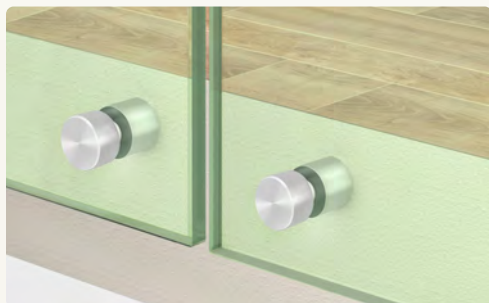

H1308 Pieza
Cristal de 6 - 19 mm

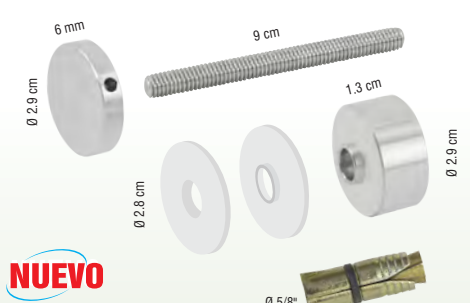

CMC Pieza
Cristal de 6 - 19 mm

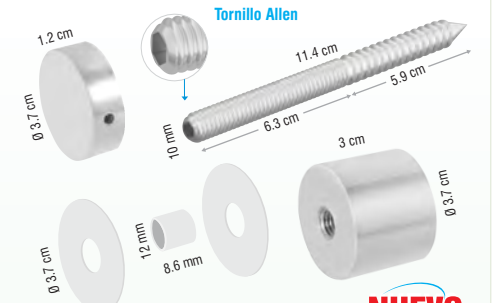
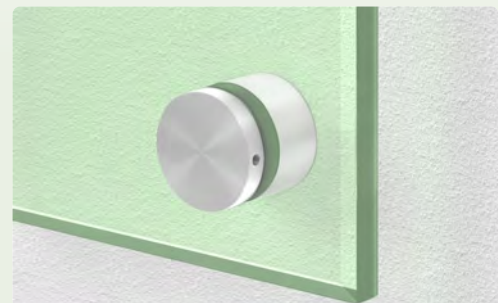

H1309 Pieza
Cristal de 6 - 19 mm

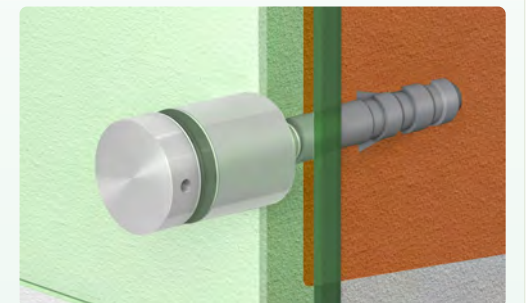



VISTA COLONIAL

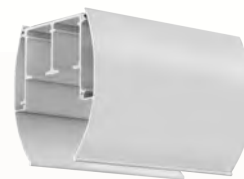

**INCLUYE: RIEL, TAPAS CURVAS Y
COMPLEMENTOS ESENCIALES**

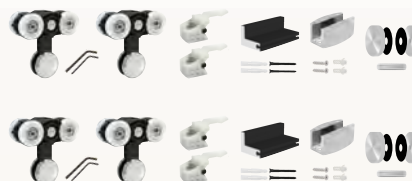

" Sin Cristales "

CRISTAL 6 mm

C6C12 1.20 m
C6C15 1.50 m
C6C20 2.00 m

CRISTAL 9 mm

C9C12 1.20 m
C9C15 1.50 m
C9C20 2.00 m

Con Resistencia Marina

CRISTAL 6 mm

C6C12R 1.20 m
C6C15R 1.50 m
C6C20R 2.00 m

CRISTAL 9 mm

C9C12R 1.20 m
C9C15R 1.50 m
C9C20R 2.00 m

Acabados:

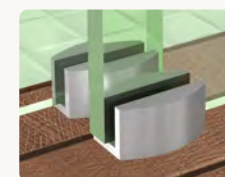

Guía Inferior



Jaladera Perilla Doble

JUEGO POR HOJA MÓVIL

EN MEDIDAS ESPECIALES SE RECOMIENDA POR TRAMO



RESAQUES AL CRISTAL

Resaque de Carretilla Perforación de Jaladera

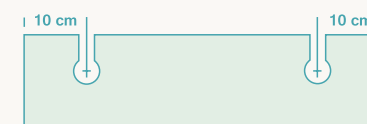
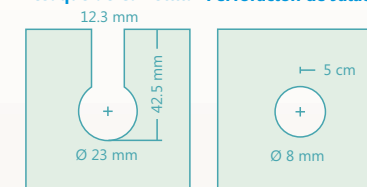

Distancia del Resaque en Carretillas

CRISTAL 6 mm

JCT6 Juego
JCT6C 4 Juegos
JCT6G 8 Juegos

Resistencia Marina

JCT6R Juego
JCT6RC 4 Juegos
JCT6RG 8 Juegos

CRISTAL 9 mm

JCT9 Juego
JCT9C 4 Juegos
JCT9G 8 Juegos

Resistencia Marina

JCT9R Juego
JCT9RC 4 Juegos
JCT9RG 8 Juegos

CANCEL DE BAÑO

JALADERA TOALLERO



CB120 1.20 m
CB150 1.50 m
CB200 2.00 m

"Sin Cristal"



Herrajes Incluidos :

- 4 Carretillas
- 2 Jaladeras
- 1 Guía Inferior Plást.
- 6 Tapa y Tope para Jamba
- 2 Grapa Unión P/ Riel Sup.



Y1 50 cm
Y2 30 cm
X 6.5 cm
D 2.5 cm
P 3/8"
C/C 47 cm
C/C 27.5 cm

J228 Pieza
J228C 4 Piezas
J228G 8 Piezas



SIMBOLOGÍA DE JALADERA

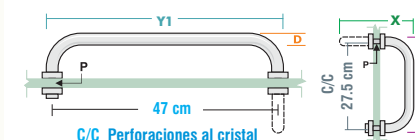

BASE RECTA

Cristal 6 - 10 mm

2462 Pieza Satin
2462C 10 Piezas Satin
2462G 20 Piezas Cromo

Cristal 6 mm

3035 Pieza Satin
3035C 20 Piezas Satin
3035G 40 Piezas Satin

BASE CURVA

6 - 9 mm
Para tubo redondo de 2"
Clave: 1115

2461 Pieza Satin
2461C 10 Piezas Satin
2461G 20 Piezas Cromo

6 mm
Para tubo redondo de 1 1/4"
Clave: 3066

3034 Pieza Satin
3034C 20 Piezas Satin
3034G 40 Piezas Satin

Cristal 6 - 9 mm

2025 Pieza Satin
2025C 50 Piezas Satin
2025G 100 Piezas Cromo

Cristal 9 - 12 mm

3109 Pieza Satin Cromo
3109C 20 Piezas Satin Cromo
3109G 40 Piezas Satin Cromo

Cristal 6 mm

1160 Pieza Satin Cromo
1160C 20 Piezas Satin Cromo
1160G 40 Piezas Satin Cromo

Cristal 6 mm

1160P Pieza Satin
1160PC 20 Piezas Satin
1160PG 40 Piezas Satin

Cristal 6 - 9 mm

3032 Pieza Satin Cromo
3032C 50 Piezas Satin Cromo
3032G 100 Piezas Satin Cromo

Cristal 6 - 9 mm

2877 Pieza Satin Cromo
2877C 20 Piezas Satin Cromo
2877G 40 Piezas Satin Cromo

CLIPOS - SIN RESAQUE AL CRISTAL

Apertura hasta 45 mm

3260 Par Satin
3260C 10 Pares Satin
3260G 20 Pares Cromo

Apertura hasta 22 mm

2160 Par Satin
2160C 10 Pares Satin
2160G 20 Pares Cromo

Apertura hasta 26 mm

2689P Par Satin
2689PC 10 Pares Satin
2689PG 20 Pares Cromo

Apertura hasta 16 mm

2688 Par Satin
2688C 20 Pares Satin
2688G 40 Pares Cromo

Apertura hasta 23 mm

1767 Par Satin Cromo
1767C 10 Pares Satin Cromo
1767G 20 Pares Satin Cromo

Apertura hasta 19 mm

3155 Par Satin Cromo
3155C 20 Pares Satin Cromo
3155G 40 Pares Satin Cromo



Apertura hasta 22 mm

1154 Par Satin

TAPAS DE ALUMINIO



2.5 cm
Ø 6.7 cm
Ø Interior 6 cm

TP2 Pieza
TP2C 10 Piezas
TP2G 20 Piezas
Instalación: 23896 y 623896



2.5 cm
Ø 8.2 cm
Ø Interior 7.5 cm

TP3 Pieza
TP3C 10 Piezas
TP3G 20 Piezas
Instalación: 11559



2.5 cm
Ø 10.7 cm
Ø Interior 10.2 cm

TP4 Pieza
TP4C 10 Piezas
TP4G 20 Piezas
Instalación: 11945



PASAMANOS REDONDO

TAPAS DE ALUMINIO



Ø 5 cm
4 mm 2.1 cm
Ø 4.8 cm

3135
Instalación Perfil 22083

Aluminio



Ø 7.6 cm
4.7 mm 2.6 cm
Ø 7.3 cm

3136
Instalación Perfil 22085

Aluminio

TAPA ACERO INOXIDABLE



Ø 5 cm
1.2 cm 4.9 cm

3134
Instalación en Tubo de Aluminio y Acero Inoxidable 2"

TAPA ZAMAK



Ø 5 cm
2.6 mm 1.16 cm
Ø 4.7 cm

3133 Satin
Instalación en Tubo de Aluminio y Acero Inoxidable 2"

SOPORTE PASAMANOS

Aluminio



5.9 cm
Perfil 11560

SP 10 cm
SPM 1 m

NM BCO NG

EP



20.3 cm
20.3 cm
5.9 cm

NM
EP Escuadra Pasamanos

COMBINABLE CON: 11559 23896 623896

PASAMANOS OVALADO

Aluminio



5.9 cm
Perfil 11561

SPN 10 cm
SPN1 1 m

NM BCO NG

Plástico



7.3 cm
2.3 cm

Blanco Gris Negro

TPP Pieza
TPPC 20 Piezas
TPPG 40 Piezas
Instalación: 9366

CALZAS ZOCLO BARANDAL



5.0 cm 1.9 cm
6.3 cm

ZB10
Calza Zoclo Barandal
Cristal 10 mm

■ Negro



5.0 cm 1.9 cm
6.3 cm

ZB12
Calza Zoclo Barandal
Cristal 12 mm

■ Negro

PASAMANOS ACERO INOXIDABLE 304

TUBOS CON EXTREMOS SELLADOS

Longitud 6 m Espesor 0.7 mm

Ø 1 1/4" **3066P** Pieza **3066PC** 5 Piezas **3066PG** 10 Piezas

Longitud 6 m Espesor 0.8 mm

Ø 2" **3142** Pieza **3142C** 5 Piezas **3142G** 10 Piezas

Longitud 6 m Espesor 1 mm

Ø 2" **3142P** Pieza **3142PC** 5 Piezas **3142PG** 10 Piezas

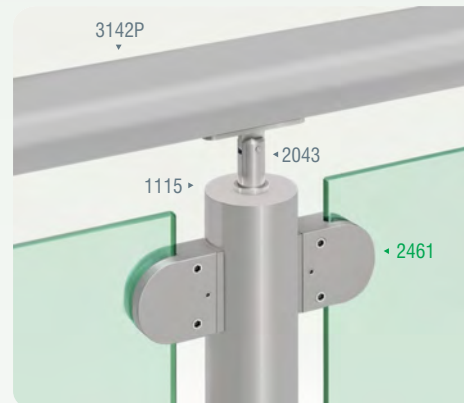

3142P
1115
2043
2461

POSTES

Ø 1 1/4"



1 m

Accesorio Base Curva
Se vende por Separado



3034

Tapa Tornillos

BASE SOLDADA EN ACERO INOXIDABLE

Ø 2 1/2"

Ø 2"



1 m

Accesorio Base Curva
Se vende por Separado



2461

Tapa Tornillos

BASE SOLDADA EN ACERO INOXIDABLE

Ø 3 1/2"

CPBC Conector a Poste Base
Acero Inox. 3.2 cm Ø 2.1 cm

UT Niple Unión Tubo de 2"
Acero Inox. 5.1 cm Ø 4.7 cm

CRT Codo Recto 90° a Tubo 2"
Acero Inox. 9.6 cm Ø 4.7 cm

Muro a Tubo

Tubo 1 1/4" y 2"



Ø 1.19 cm Ø 1.5 cm
22 cm

671 Pieza
671C 10 Piezas
671G 20 Piezas

Cristal a Tubo

Cristal 9 - 12 mm



Ø 1.19 cm Ø 1.5 cm
19 cm

3078 Pieza
3078C 10 Piezas
3078G 20 Piezas

Cristal a Tubo

Cristal 9 - 12 mm



Ø 1.19 cm Ø 1.5 cm
10.5 cm

CCP Pieza

Conector Poste 2"



6.4 cm 2.6 cm
Ø 2.1 cm Ø 5/8"

2043 Pieza
2043C 15 Piezas
2043G 30 Piezas

Agregar a la Clave: **C** Caja 4 Juegos "o" **G** Caja 8 Juegos



CLAVE	Y	D	P	C/C	X
J213-30	30 cm	Ø 3.7 cm	Ø 3/8"	20 cm	4.5 cm
2697	45 cm	Ø 2.4 cm	Ø 3/8"	30.5 cm	3.7 cm
J213-45	45 cm	Ø 3.7 cm	Ø 3/8"	30 cm	4.1 cm
2022	50 cm	Ø 3.1 cm	Ø 3/8"	30 cm	4.7 cm
2278	50 cm	Ø 3.1 cm	Ø 3/8"	35 cm	4.8 cm
J213-60	60 cm	Ø 3.7 cm	Ø 3/8"	40 cm	4.1 cm
2861	65 cm	Ø 3.1 cm	Ø 1/2"	45 cm	4.4 cm
2903	80 cm	Ø 2.9 cm	Ø 1/2"	60 cm	4.4 cm
2400	100 cm	Ø 3.1 cm	Ø 5/16"	80 cm	4.2 cm
3057	120 cm	Ø 3.1 cm	Ø 3/8"	80 cm	4.5 cm
2422	150 cm	Ø 3.2 cm	Ø 3/8"	100 cm	4.5 cm



JUEGO DE JALADERA SIMBOLOGÍA

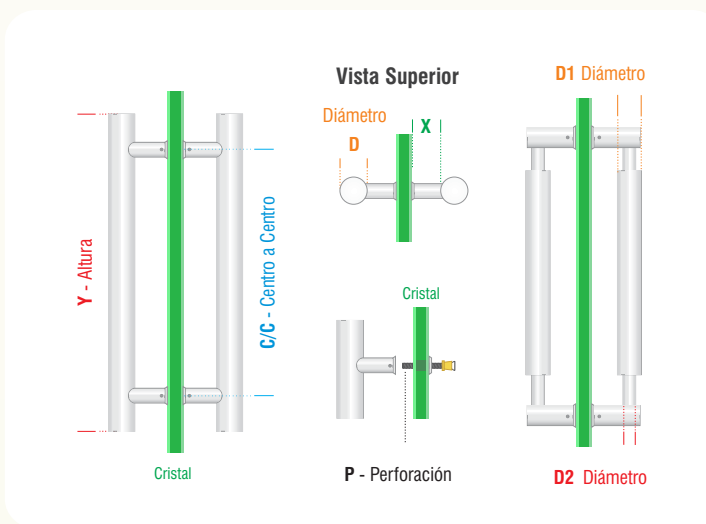

2873



Y	45 cm
D	Ø 2.4 cm
P	Ø 5/16"
C/C	30 cm
X	3.2 cm

Satín con Cromo



J127



Y	60 cm
D	Ø 3.2 cm
P	Ø 3/8"
X	4.2 cm

Ajustable



J178



Y	50 cm
D1	Ø 3 cm
D2	Ø 4 cm
P	Ø 3/8"
C/C	40 cm
X	4.1 cm



2874



Y	45 cm
D	Ø 2.4 cm
P	Ø 5/16"
C/C	30 cm
X	4.3 cm

Satín Cromo



2945



Y	50 cm
D	Ø 2.5 cm
P	Ø 3/8"
C/C	30 cm
X	4.1 cm



TRJ

Tornillos 5/16"
Par

Instalación en Aluminio



2023



Y	37.7 cm
D	Ø 3 cm
P	Ø 3/8"
C/C	30 cm
X	3.5 cm

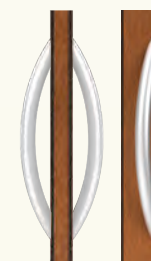

Agregar a la Clave: **C** Caja 4 Juegos "o" **G** Caja 8 Juegos



JUEGO DE JALADERA SIMBOLOGÍA

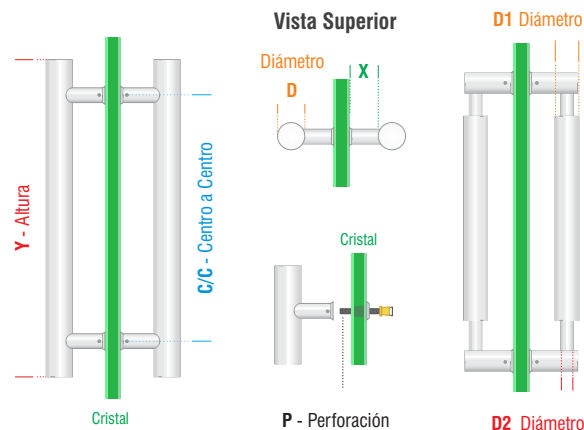

TRJ
Tornillos 5/16"
Par
8.1 cm
Instalación en Aluminio



J208

Y	45 cm
D1	2.2 cm
D2	3.14 cm
P	3/8"
C/C	42 cm
X	4.5 cm



2728

Y	30 cm
C/C	27.5 cm
X	6.9 cm
D	2.5 cm
P	3/8"



J230

Y	19.8 cm
C/C	17 cm
X	4 cm
D	2.5 cm
P	3/8"



J232

Y	20 cm
C/C	17.5 cm
X	10.5 cm
D	2.5 cm
P	3/8"



2123

Y	40 cm
D	4 cm
P	3/8"
C/C	30 cm
X	7 cm

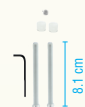

J117

Y	60 cm
D1	2.5 cm
D2	3.8 cm
P	3/8"
C/C	56.5 cm
X	5 cm



1151

Y	17 cm
D	2.5 cm
P	3/8"
C/C	15 cm
X	4.5 cm



1476

Y	30 cm
D	2.5 cm
P	3/8"
C/C	27.5 cm
X	4.5 cm



2719

Y	33.5 cm
D	3 cm
P	3/8"
C/C	30.5 cm
X	4.5 cm



2029

Y	27 cm
D	2 cm
P	3/8"
C/C	25 cm
X	3.8 cm



1442

Y	30 cm
D	2.5 cm
P	3/8"
C/C	27 cm
X	5 cm



Y	34 cm
D	3.2 cm
P	3/8"
C/C	30.5 cm
X	5 cm



2720
Pieza
2720C
6 Piezas
2720G
12 Piezas



3105

Y	40 cm
D	3.3 cm
P	3/8"
C/C	33 cm
X	6.3 cm



J115

Y	50 cm
D	3.2 cm
P	3/8"
C/C	47 cm
X	7.2 cm



2033

Y	35.8 cm
D	Ø 2.5 cm
P	Ø 3/8"
C/C	30 cm
X	3.5 cm



JALADERAS ACERO INOXIDABLE

2665

Y	180 cm
D	3.2 cm
P	3/8"
C/C	150 cm
X	4.7 cm

9.5 cm

Satin

2943

Y	50 cm
D1	1.5 cm
D2	3.2 cm
P	1/2"
C/C	27.5 cm
X	4 cm

1/4"

3.4 cm

Satin Cromo

Aluminio

989

Y	25.5 cm
D	2.5 cm
P	5/16"
C/C	23 cm
X	4.2 cm

989C
4 Piezas

989G
8 Piezas

1/4"

10.3 cm

Natural Blanco Beige
Gris Hueso Negro

JUEGO DE JALADERA SIMBOLOGÍA

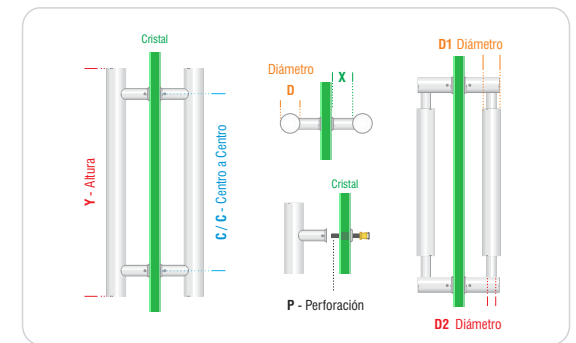

JALADERAS CON CERRADURA INTEGRADA

3126

Y	150 cm
D	3.5 cm
PS	1"
Pi	5/8"
C/C	112.5 cm
X	8.3 cm

Acero Inoxidable

Perforación Superior
1"

Mariposa Cerradura Integrada

Perforación Inferior
5/8"

5 cm

3.5 cm 7.5 cm 3.3 cm 6 cm 2.1 cm
Ø 1.6 cm

Perforación Inferior

JUEGO DE JALADERA SIMBOLOGÍA

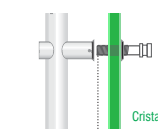
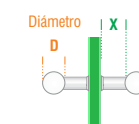
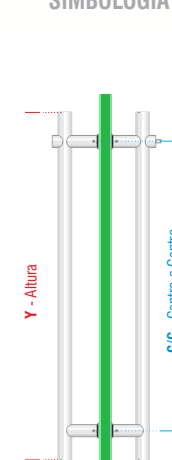

PS - Perforación Superior

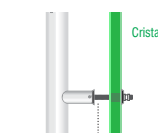

Cerradura Integrada

Sencilla

3127

Y	150 cm
D	3.5 cm
PS	1"
Pi	5/8"
C/C	112.5 cm
X	11.5 cm

Acero Inoxidable

7.5 cm 3.3 cm 6 cm 2.1 cm
3.5 cm Ø 1.6 cm

3.5 cm

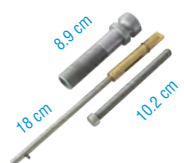

TJL
Juego de Fijación
Jaladera Larga 3126

Instalación en Aluminio



ACABADO CROMO



1525
Soporte Intermedio



1528
Base Fija Superior



1527
Base Inferior Ajustable



1526 metro
1526R 50 m

Cable de Acero Inoxidable
Base 1 m. (Ø 2 mm)



1529
Base Superior Movable



2273
Soporte Sencillo Interior sin Perforar 6 - 9 mm



1530
Gancho



2274
Gancho

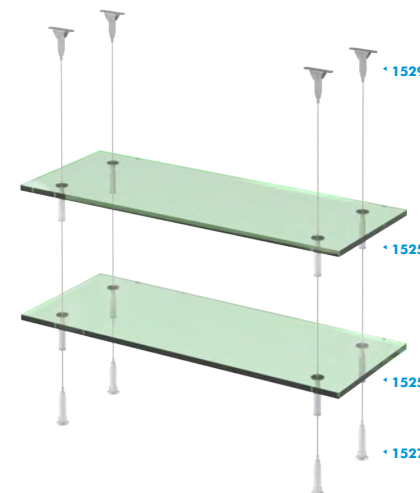

SEPARADORES DE ALUMINIO PARA CRISTAL DOBLE

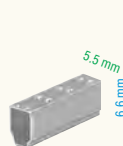

Separador 5.5 mm x 5 m

1879 Pieza
1879C 100 Piezas
1879G 200 Piezas

SA

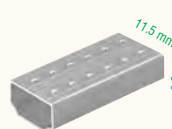

Separador 11.5 mm x 5 m

2319 Pieza
2319C 100 Piezas
2319G 200 Piezas

SA



Silica Gel
Grano 0.5 - 0.9 mm
1 Kg

1641 1 Kg
1641C 10 Kg
1641G 25 Kg

Rendimiento Aprox. :
Separador 5.5 mm 46 m
Separador 11.5 mm 20 m

NUEVO



687 Rollo
687C 20 Rollos
687G 40 Rollos

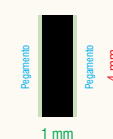

Cinta Butil (Rollo 30 m.)

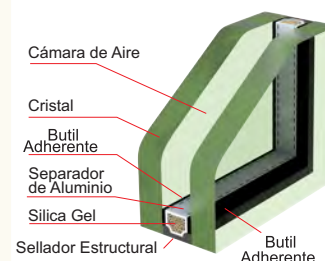

1877 Pieza
1877C 50 Piezas
1877G 100 Piezas

■ Negro



2766
Unión para Separador de 5.5 mm

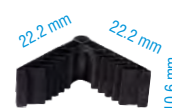

2320 Pieza
2320C 50 Piezas
2320G 100 Piezas

■ Negro



2952
Unión para Separador de 11 mm



2333
Prensa de Resorte 2"

CUADRÍCULA INTERNA

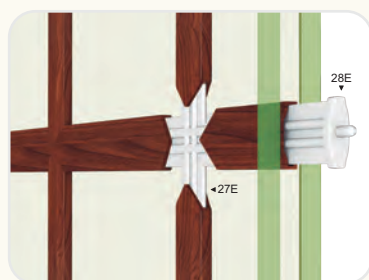

Perfil 12393

Perfil 12393 - Corte 45°

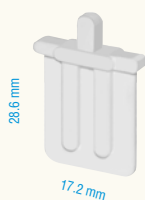

Remate

28E Pieza
28EC 100 Piezas
28EG 200 Piezas

Acabados: Blanco Negro

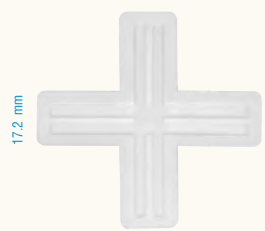

Cruz

27E Pieza
27EC 100 Piezas
27EG 200 Piezas

Acabados: Blanco Negro

Perfil 15043

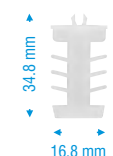

2639
Remate

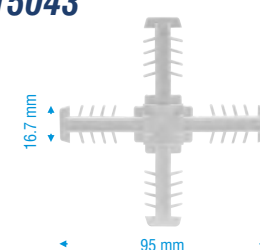

2638
Cruz

Super Spacer Rollo 20 m

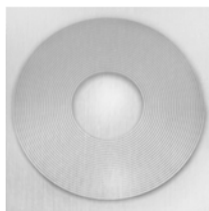

Requieren Sellador de Poliuretano

	Base	Altura	Acabado
3106	3/16" 4.76 mm	1/4" 6.35 mm	Negro
2091	1/4" 6.35 mm	1/4" 6.35 mm	Gris
646	1/4" 6.35 mm	3/16" 4.76 mm	Negro
2518	3/8" 9.52 mm	1/4" 6.35 mm	Gris
2519	1/2" 12.70 mm	1/4" 6.35 mm	Gris

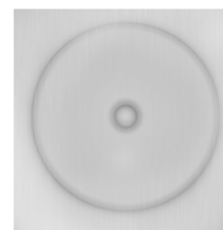

No Requiere Sellador

2338 Swiggle Rollo 29 m

Base	Altura
3/8" 9.52 mm	1/4" 6.35 mm

■ Negro

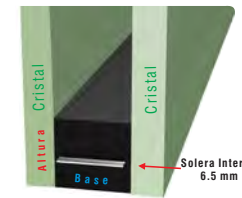

Las Cintas para Cristal Doble Después de Abierto el Empaque se **Caduca en 3 Meses.** Tienen un Año de Caducidad Después de la Fecha de Fabricación y Funcionan Perfectamente aún Teniendo Aire en el Empaque.

CINTAS ADHERENCIA POR AMBOS LADOS

541
3/4" x 3/64" x Metro
Base Altura Largo

912
1/2" x 1/8" x Metro
Base Altura Largo

2735
1/4" x 3/64" x Metro
Base Altura Largo

1454
1/4" x 1/8" x Metro
Base Altura Largo

633
3/8" x 1/4" x Metro
Base Altura Largo

1105
1/4" x 1/4" x Metro
Base Altura Largo

541R
Rollo de 61 m

912R
Rollo de 31 m

2735R
Rollo de 61 m

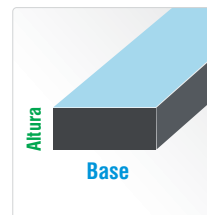

1454R
Rollo de 31 m

633R
Rollo de 15.5 m

1105R
Rollo de 15.5 m

Fachada Integral

Pega Policarbonato

912B
1/2" x 1/8" Metro
Blanca Base Altura Largo

2453
1/4" x 0.40" Metro
Transparente Base Altura Largo

2454
1/2" x 0.40" Metro
Transparente Base Altura Largo

912BR
Rollo de 26 m

2453R
Rollo de 33 m

2454R
Rollo de 33 m

Limpieza de Superficies



1640
Alcohol Isopropilico 1 lt.

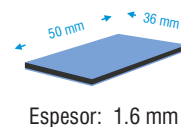

Espesor: 1.6 mm

1391 Pieza
3.6 cm x 5 cm
Base Altura

ADHERENCIA POR UN LADO

1019
3/8" x 3/16" x Metro
Base Altura Largo

2656
3" x 1/4" x Metro
Base Altura Largo

1019R
Rollo de 7.5 m

2656R
Rollo de 15.5 m



CALZAS DE NEOPRENO DUREZA 90 SHORE A



301
Base Altura Largo
3/8" x 3/16" x 10 cm



2780
Base Altura Largo
3/8" x 1/8" x 10 cm

2780C
50 Piezas
2780G
100 Piezas



302
Base Altura Largo
3/8" x 1/4" x 10 cm

302C
50 Piezas
302G
100 Piezas

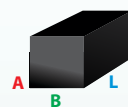

303
Base Altura Largo
3/8" x 3/8" x 10 cm

303C
50 Piezas
303G
100 Piezas

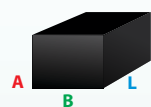

2837
Base Altura Largo
1/2" x 3/8" x 10 cm

2837C
50 Piezas
2837G
100 Piezas



Base Altura Largo
1.27 cm 0.635 cm Largo

CN12P
1/2" x 1/4" x 10 cm
CN12PC
50 Piezas
CN12PG
100 Piezas



Base Altura Largo
2.22 cm 0.635 cm Largo

CN78P
7/8" x 1/4" x 10 cm
CN78PC
50 Piezas
CN78PG
100 Piezas



Base Altura Largo
2.22 cm 0.952 cm Largo

CN38P
7/8" x 3/8" x 10 cm
CN38PC
50 Piezas
CN38PG
100 Piezas

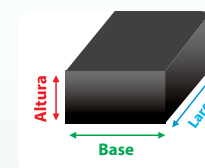



6 Rulinas
Carburo de Tungsteno
1452
Silberschnitt
Mango de Madera



1822
Cabezal de Reemplazo



1 Rulina
Carburo de Tungsteno
422
Fletcher
Mango Metálico



NUEVO
3168
Importado
Mango Metálico



1450
Toyo
Mango Metálico



1648
Cabezal de Reemplazo



1897
Silberschnitt
Mango Metálico



1639
1 Litro
Lubricante
Corta Vidrios

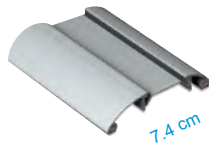

REGLA DE CORTE
Cortado del Perfil 5019
1108 1.92 m.
1107 2.90 m.



CORTA CÍRCULOS
1828
Fletcher
Ø 1.2 cm a Ø 12.7 cm
Rulina de Acero



2131 Corte Hasta 0.60 m.
925 1.20 m.
853 2.00 m.
Silberschnitt



444
Corredera
6 Rulinas de Acero

PELÍCULA ADHERIBLE

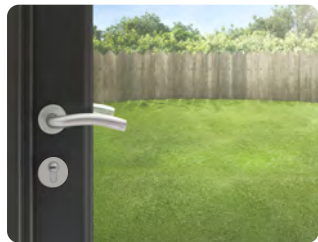

Transparente de Seguridad
Ancho 1.52 m Espesor: 150 Micras

2322 Metro
2322R Rollo 30 m.
2322RG 4 Rollos de 30 m.

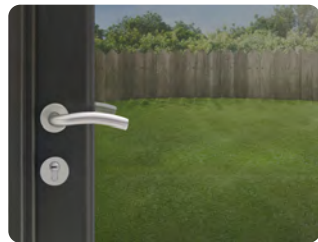

Humo de Seguridad
Ancho 1.52 m Espesor: 170 Micras

NUEVO
3087 Metro
3087R Rollo 30 m.
3087RG 4 Rollos de 30 m.

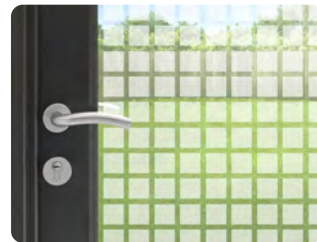

Decorativa de Cuadros
Ancho 1.52 m Espesor: 90 Micras
10 mm Claro y 40 x 40 mm Esmerilado

1997 Metro
1997R Rollo 30 m.
1997RG 4 Rollos de 30 m.

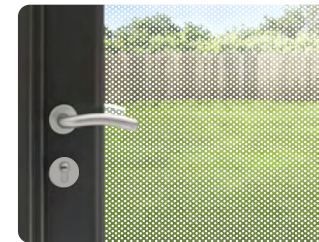

Decorativa de Puntos
Ancho 1.52 m Espesor: 80 Micras

PTP Metro
PTPR Rollo 30 m.
PTPRG 4 Rollos de 30 m.

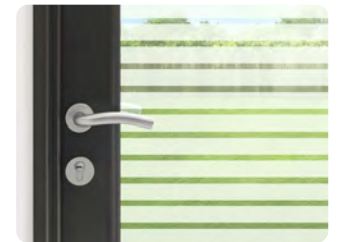

Decorativa de Rayas
Ancho 1.52 m Espesor: 90 Micras
10 mm Claro y 30 mm Esmerilado

2928 Metro
2928R Rollo 30 m.
2928RG 4 Rollos de 30 m.

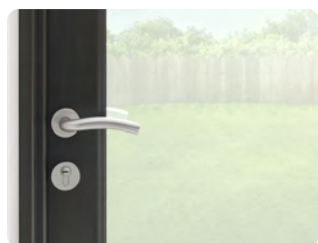

Esmerilada Blanca Mate
Ancho 1.52 m Espesor: 70 Micras

2637 Metro
2637R Rollo 30 m.
2637RG 4 Rollos de 30 m.

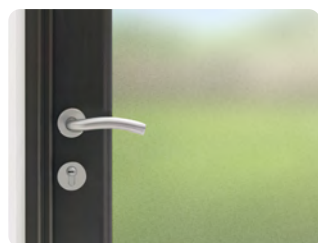

Satinovo
Ancho 1.52 m Espesor: 140 Micras

PS220 Metro
PS220R Rollo 30 m.
PS220RG 4 Rollos de 30 m.

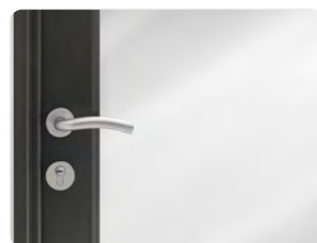

Plateada
Ancho 1.52 m Espesor: 30 Micras

2964 Metro
2964R Rollo 30 m.
2964RG 4 Rollos de 30 m.

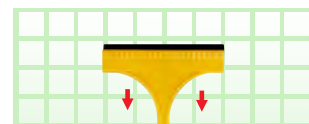

Aplique la Película con el Jalador



JE Juego
JEC 20 Juegos
JEG 40 Juegos



Retire el Exceso de Agua con la Espátula

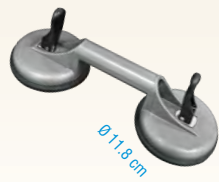

VG5 Pieza
VG5C 4 Piezas
VG5G 8 Piezas
 Capacidad: **80 Kg**

Gris



VG7 Pieza
VG7C 4 Piezas
VG7G 8 Piezas
 Capacidad: **80 Kg**

Cromo



VENT3 Pieza
VENT3C 4 Piezas
VENT3G 8 Piezas
 Capacidad: **75 Kg**

Gris

Veribor



Ø 12 cm

1333

Capacidad: **100 Kg**



Ø 12 cm

2293

Repuesto

Power Grip



30 cm
24 cm

893

Capacidad: **57 Kg**



Ø 20 cm

2296

Repuesto



27.7 cm
24 cm

2136

Capacidad: **85 Kg**

ACCESORIOS DE SEGURIDAD

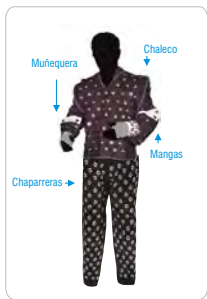

Perforaciones con Ojillos de Acero - Unitalla



2015
Muñequera (par)



2459
Mangas (par)



2458
Chaleco



3264
Chaparreras

Guantes



424
Cortos con Látex



321
Largos Importados

Cinta



1796
2" x 50 m
 Transp. Café

ESPEJO CONVEXO



Frente

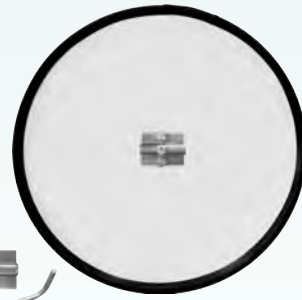

Reverso

Espejo con Base Integrada

2962 Ø 36 cm
2420 Ø 52 cm
2421 Ø 72 cm

DETALLADO EN CRISTALES



323
Polvo de Esmeril
Grano # 60
1 Kg



2044
Oxido de Cerio
Abrillantador para Cristal
1 Kg



2797
Yeso Piedra
1 Kg

Blanco
 Gris

Pega Cristal con Cristal



2315
Adhesivo Estructural
Metal - Cristal 20 ml. / 170 g.

HERRAMIENTAS PARA CRISTAL



1478
Pinza Curva
Abrecorte

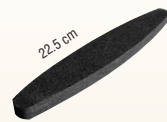

832
Piedra para
Pulir Cantos



1477
Pinza Recta

Bupón



1559
Bupón para Mesa
de Cristal (Pieza)

Soporte de Espejo



1481M 3 mm
1481 6 mm

A

Ángulo para Escuadra	230
Avellanadores	232

B

Balancín Ventana Guillotina	217
Barras Antipánico	207
Barras de Armado	212
Barras de Empuje	207
Barra a Muro	218
Bisagra Bandera	211
Bisagra de Piano	211
Bisagra Doble Acción	204
Bisagras de Libro	211
Bisagras Hidráulicas	204
Bisagras Hidráulicas Aéreas	204
Bisagras Reversibles	208
Bisagras Triple Reforzada	210
Black Out	220
Brazo Fricción	216
Brazo Telescópico	213
Brazos Ventana de Proyecc.	216
Brocas Alta Velocidad	232

C

Cadena Metálica	213
Cadena Plástica	214
Cancel de Baño	218
Carretillas	185
Carretillas Cancel de Baño	218
Carretillas Mosq. Colgante	188
Carretillas Mosq. Corredizo	186
Carretillas Riel Superior	187
Carretillas Vent. Panorámica	188
Contras	192
Cubiertas Traslapes	194
Cierre Bayoneta	203
Cierre Bayoneta con Perilla	203
Cierre de Gancho	203
Cierre Mariposa	203
Cierre Paleta	203
Cierra Puertas	205
Cierre Final	213
Carrucha para Operador	214
Carrucha Inst. Vinil Mosq.	219
Cortinas de Aire	219
Carrucha Inst. de Vinil	222
Cremallera de Aluminio	225

Conectores	226
Cortadora Manual	232
Copiadora	234

CH

Chapas	199
Chapa para Vitrina	226
Chapas Acero Inox. 304	201
Chapas Huella Digital	202
Chapas Puerta de Madera	202
Chapas Residenciales	202

D

Discos de Corte	235
Distanciómetro	232
Detector de Humo	217

E

Escuadras de Armado	230
Exactos	232

F

Felpas	221
Fleje Mosquitero	219
Flexómetros	232
Fresadora	233
Fresas	233

G

Ganchos Broche de Embutir	192
Garfios	232
Guardapolvo	213
Guillotina	217

H

Herramientas	232
--------------	-----

I

Imanes para Mosquitero	220
Imanes Neodimio	203

J

Jaladera Broche Guillotina	217
Jaladera Broche Perico	195
Jaladera Tirador	195
Jaladera Trompa Elefante	195
Jaladeras Acero Inox. 304	196
Jaladeras Broche de Embutir	189
Jaladeras Concha	198
Jaladeras Sobrepuestas	195
Juntas de Estanqueidad	194

L

Lector Digital	235
Lubricante para Discos	235

M

Manijas Ventana Proyecc.	215
Marcadores para Detallar	237
Matracas	212
Ménsulas	225
Mosquitero	219
Mosquiteros Enrollables	219
Muestrarios de Acabados	237

O

Operadores de Brazo	214
---------------------	-----

P

Pasador Maroma	206
Perfiles al Corte	228
Pijas y Tornillos	224
Pinza de Presión	232
Pistólas de Calafateo	220
Pivotes Centrados	206
Pivotes Descentrados	206
Prensa Hidráulica Giratoria	236
Puntas para Atornillador	232
Posicionador	213

R

Remachadoras	225
Remaches	225
Remaches Roscados	225
Resortes Mosquitero	219
Retenes Mosquitero	219

S

Sardineles	228
Seguro Escarabajo	219
Selladores	220
Sifón	192
Sistemas Automáticos	217
Sistema Multipunto	190
Soportes Sifón	192

T

Taladro	232
Tapa Bisagra	228
Tapa Guardapolvo	213
Tapa Tubo Rectangular	228
Tapa Viga	228
Tapas Zoclo	213
Tapas Laterales Sifón	192
Tapas para Corredizas	194
Tapones	193
Taquetes	225
Taquete Expansión	224
Telas Mosquitero	219
Tensores	212
Tirador de Seguridad	195
Topes de Piso	193
Topes	193
Tornillos Jaladeras Cristal	196
Transformador Chapa Eléct.	202
Tríptico de Acabados	237
Troqueles	236

U

Uñeros Embutidos	189
Uñeros Sobrepuestos	189

V

Vinilos	222
Vitrinas	226

Grabados

Mosaico	239
Opalen	239
Delfín	239
Olivo Pastel	239
Filigrana	239
Lluvia	239
Dominó	239
Gaviota	240
Cristalen	240
Decorlen	240

Acrílicos

Cristal	240
Z-01 Blanco	240
Perlescente Blanco	240
Perlescente Café	240
Perlescente Marfil	240
Rejilla Plástica	240

Acrílicos y Plásticos Decorados

Alcatraz	241
Alcatraz 2	243
Barco	243
Cerezo	243
Cisne	242
Cisne I	241
Colibrí II	243
Dama en la Fuente	242
Delfín	242
Delfines II	241
Flamingos II	243
Griega	242
Guacamaya	241
Japonesa	242
Peces	241
Ramillete de Alcatraz	243
Rosal	243
Sirenita I	242
Sirenita II	242
Stambul	241
Tropical 2	243

MDF Dos Vistas	238
Foamular	238
Puertas Multipanel	238

CLAVE / PAG.		CLAVE / PAG.		CLAVE / PAG.		CLAVE / PAG.		CLAVE / PAG.		CLAVE / PAG.		CLAVE / PAG.		CLAVE / PAG.			
1	231	93PC	206	171-3	217	247G	189	458	200	801	218	1002	202	1476	197	1578CG	215
1G	231	93PG	206	172	217	249	218	459	219	805ND	214	1006	206	1479	195	1578R	215
2	211	103P	224	172-2	217	249C	218	459R	219	805NDC	214	1006CC	206	1479L	195	1578RC	215
2TCP	193	103PC	224	172-3	217	249G	218	459RG	219	805NDG	214	1006CG	206	1492	198	1578RG	215
2TCPC	193	103PG	224	173	217	249R	195	460	200	805Ni	214	1009	218	1511	226	1592	220
2TCPG	193	104P	224	173-2	217	250	218	462	200	805NiC	214	1016	206	1519	226	1592C	220
6	211	104PC	224	173-3	217	251	218	466	204	805NiG	214	1020	207	1521ND	211	1633	200
6C	211	104PG	224	174	217	255	205	471	225	805PD	214	1021	207	1521Ni	211	1637	216
6G	211	105P	224	174-2	217	260	218	471C	225	805PDC	214	1024	200	1522P	210	1670	220
9	204	105PC	224	174-3	217	261	218	472	200	805PDG	214	1036	200	1522PC	210	1670C	220
10X	235	105PG	224	175	217	282	218	472P	199	805Pi	214	1036C	200	1522PG	210	1677	226
14	226	107	224	175-2	217	283	218	472PC	199	805PiC	214	1036G	200	1523P	209	1730MC	200
15	213	107P	224	175-3	217	295	231	472PG	199	805PiG	214	1036P	200	1523PC	209	1730MCC	200
15E	194	107PC	224	176	217	326	200	477P	185	838	207	1044	212	1523PG	209	1730MCG	200
15R	213	107PG	224	176-2	217	326C	200	477PC	185	838P	207	1044C	212	1524F	210	1730NM	200
16E	193	108	224	176-3	217	326G	200	477PG	185	838PC	207	1044G	212	1524FC	210	1730NMC	200
16EC	193	108P	224	177	219	328	220	478	185	838PG	207	1069	229	1524FG	210	1730NMG	200
16EG	193	108PC	224	177R	219	328C	220	478CC	185	839	203	1070	229	1524L	210	1781	229
19E	188	108PG	224	183	213	328P	220	478CG	185	844	220	1070C	229	1524LC	210	1781C	229
20E	195	109P	224	185	200	328PC	220	484DC	200	850D	207	1070G	229	1524LG	210	1781G	229
21	187	115	225	187	187	335	225	484MC	200	850i	207	1071	229	1525P	209	1783	203
22	226	115C	225	189	195	335C	225	484P	199	851	204	1071C	229	1525PC	209	1783C	203
23E	194	115G	225	190	195	335G	225	484PC	199	852	217	1071G	229	1525PG	209	1783G	203
24	185	117	219	190	217	341	225	484PG	199	864	213	1089	200	1539	218	1815	220
24CC	185	119	217	191	219	348	203	492	225	872	220	1089P	199	1553	220	1815M	220
24CG	185	121	212	191R	219	352	218	496	225	872C	220	1089PC	199	1563	187	1818	232
25E	219	122	218	191RG	219	356	204	500	225	878	198	1089PG	199	1566	230	1840	226
26D	214	126P	220	195	228	367	198	517	232	885	218	1129P	212	1566C	230	1856	218
26DC	214	126PC	220	196	228	370	217	521TK	218	885C	218	1129P	224	1566G	230	1863	232
26DG	214	126T	220	197	228	373	219	534P	188	885G	218	1151	197	1567	230	1880	206
26E	190	126TC	220	198	228	383	200	534PC	188	888	207	1168	207	1567C	230	1905	216
26i	214	127	213	199	228	385	224	534PG	188	888P	207	1171	192	1567G	230	1906	204
26iC	214	128	213	213	219	396	188	549P	199	888PC	207	1184	202	1568	230	1909	208
26iG	214	134	213	213R	219	397	198	549PC	199	888PG	207	1280	213	1568C	230	1909C	208
28	225	137	212	215	219	398	226	549PG	199	894	190	1288T	187	1568G	230	1909G	208
30	225	137C	212	215R	219	400	226	549PM	199	894H	190	1338	218	1569	230	1909P	208
38	218	137G	212	215RG	219	401	232	549PMC	199	901	205	1394	200	1569C	230	1909PC	208
39	229	138	212	216	207	402	187	549PMG	199	910	190	1404	195	1569G	230	1909PG	208
39C	229	138C	212	217	206	403	232	607	220	911	191	1404H	195	1570	230	1910	211
39G	229	138G	212	220	207	404	232	619	225	913	190	1407	226	1570C	230	1910C	211
40	213	139	212	224	225	405	232	619C	225	914	190	1407C	226	1570G	230	1910G	211
42	195	139S	212	226	225	408	205	627	232	914PC	190	1407G	226	1571	230	1911	216
42C	195	154	224	226C	225	410	225	630	188	924	187	1409	226	1571C	230	1911C	216
42G	195	154P	224	239	219	410C	225	643	190	940	212	1409C	226	1571G	230	1911G	216
53	187	154PC	224	239R	219	416	226	655P	186	945	191	1409G	226	1572	230	1912	216
57	226	154PG	224	240	219	417	226	655PC	186	948	235	1410	200	1572C	230	1912C	216
58	198	155	224	240R	219	418	226	655PG	186	949	235	1416	232	1572G	230	1912G	216
78	214	162	218	244	189	423	219	660	189	950	191	1429	200	1573	231	1916	216
81	206	165	217	244C	189	423R	219	718	232	989	198	1431	202	1573C	231	1916C	216
89	219	166	217	244G	189	423RG	219	718C	232	1000	237	1438	187	1573G	231	1916G	216
90P	224	170	217	245	189	429	226	718G	232	1001CC	185	1442	197	1577	230	1936	200
90PC	224	170-2	217	245C	189	430	207	719	218	1001CG	185	1444	218	1577C	230	1946	216
90PG	224	170-3	217	245G	189	431	207	762	188	1001	185	1445	218	1577G	230	1948	226
93	206	171	217	247	189	450	204	765	224			1446	218	1578C	215	1950	232
93P	206	171-2	217	247C	189			781	204			1449	200	1578CC	215	1964	198

CLAVE / PAG.		CLAVE / PAG.		CLAVE / PAG.		CLAVE / PAG.		CLAVE / PAG.		CLAVE / PAG.		CLAVE / PAG.		CLAVE / PAG.			
1987	232	2191RG	219	2719	197	3008	215	BA33	212	BSL57	212	CTA2C	194	ES49C	231	GB	192
1990	201	2192	219	2720	197	3008C	215	BA57	212	BSP	187	CTA2G	194	ES49G	231	GL	192
1993	201	2192R	219	2720C	197	3008G	215	BA92	212	BT14	211	CTA3	194	ES53	230	GLC	192
1994	201	2192RG	219	2720G	197	3009	213	BAi33	212	BU1M	212	CTA3C	194	ES53C	230	GLE	192
1998	231	2193	219	2724	213	3010	213	BAi92	212	C100P	192	CTA3G	194	ES53G	230	GLEC	192
1999P	204	2193R	219	2727	202	3057	196	BB	204	C100PC	192	CV	228	ES68	231	GLEG	192
1999PC	204	2193RG	219	2728	197	3067	215	BBC	204	C100PG	192	CV2	228	ESC	229	GLG	192
1999PG	204	2200	224	2730	226	3067C	215	BBG	204	CAD4R	214	CVR	228	ESG	229	GM	192
2000P	204	2207	235	2750	213	3067G	215	BCO	219	CADM	214	DH	217	ESM	230	GMC	192
2000PC	204	2220	206	2775	219	3070	220	BD14	211	CADR	214	DL	232	EV14	229	GMG	192
2000PG	204	2220C	206	2775R	219	3070C	220	BEVN	211	CAF10	219	E12526	231	F11P	221	GP1	213
2001	231	2220G	206	2775RG	219	3094	190	BGC	219	CAF12	219	E12531	231	F11P3	221	GP1.2	213
2001C	231	2221	206	2803	214	3095	190	BLOB	220	CAF15	219	E14386	231	F11PR	221	GRL	191
2001G	231	2221C	206	2803C	214	3097	202	BLOBR	220	CAF18	219	E1523	209	F12P	221	GRLC	191
2002	231	2221G	206	2803G	214	3098	187	BLOC	220	CAF6	219	E1523	209	F12P4	221	GRLG	191
2002N	231	2236	195	2804	214	3100	189	BLOCR	220	CBA	207	E1523C	209	F12PR	221	H04	201
2003	200	2238	195	2804C	214	3100C	189	BLOH	220	CBA12	218	E1523C	209	F17P	221	H04C	201
2003P	199	2239	195	2804G	214	3100G	189	BLOHR	220	CBA15	218	E1523G	209	F17PR	221	H04G	201
2003PC	199	2240	190	2822	202	3101	189	BM	210	CBA20	218	E1523G	209	F20	221	H06	201
2003PG	199	2248	195	2822P	201	3101C	189	BMC	210	CBP12	218	E9246	231	F20R	221	H06C	201
2004	231	2256	203	2827	190	3101G	189	BMG	210	CBP15	218	EB	229	F20R4	221	H06G	201
2005	231	2258	206	2827C	190	3102	192	BO107	212	CBP20	218	EBC	229	F5L	221	H07	201
2008	231	2265	232	2827G	190	3102C	192	BO207	212	CH14	229	EBG	229	F5L3	221	H07C	201
2008C	231	2278	196	2861	196	3102G	192	BO33	212	CH35	229	EC35	229	F5LR	221	H07G	201
2008G	231	2279	213	2865	202	3103	203	BO57	212	CH3571	229	EC35C	229	F5P	221	H09	201
2009	231	2280	188	2865P	201	3103C	203	BOi33	212	CHM	229	EC35G	229	F5P4	221	H09C	201
2010	231	2282	235	2866	202	3103G	203	BOi92	212	CiN	232	EC50	229	F5PR	221	H09G	201
2022	196	2292	213	2867	202	3104	222	BP	201	CL10	201	EC50C	229	F7P	221	H10	201
2023	196	2316	190	2867P	201	3104C	222	BP12	216	CLLP	201	EC50G	229	F7P3	221	H10C	201
2029	197	2323	202	2873	196	3104G	222	BP12C	216	CLLPC	201	EM18	230	F7PR	221	H10G	201
2033	197	2326	226	2874	196	3105	197	BP12G	216	CLLPG	201	EM35	229	FAN	221	H11	201
2036	203	2327	226	2886	232	3107	189	BP16	216	CM10	201	EM35C	229	FANR	221	H11C	201
2048	224	2335	232	2901	213	3107C	189	BP16C	216	CMP	201	EM35G	229	FD	232	H11G	201
2049	224	2400	196	2902	213	3107G	189	BP16G	216	CMPC	201	EM50	229	FG1	221	H13	201
2050	224	2401P	201	2903	196	3111	237	BP20	216	CMPG	201	EM50C	229	FG200	221	H13C	201
2065	217	2408	235	2910	202	3111P	237	BP20C	216	CP	227	EM50G	229	FG4	221	H13G	201
2074	213	2422	196	2910P	201	3120	219	BP20G	216	CPO	214	EMR	231	FG6	221	IB	203
2079	211	2422	196	2911	226	3123	220	BP24	216	CPOC	214	EP14	229	FL5	221	IC	203
2094	220	2486	212	2917	203	3125	228	BP24C	216	CPOG	214	EPC	231	FL5C	221	ICC	192
2095	216	2486R	212	2917C	203	3126	198	BP24G	216	CR45	191	EPV	231	FL5R	221	ICC	220
2099	187	2564	192	2917G	203	3140	202	BP6	216	CRG	191	ES	229	FL6	221	ICCC	192
2099	187	2593	204	2931	195	3179	232	BP6C	216	CRMR	191	ES22	231	FL6C	221	ICCC	220
2123	197	2604	211	2943	198	3192	224	BP6G	216	CRZ	230	ES24	230	FL6R	221	ICCC	220
2139	205	2618	224	2945	196	20006	219	BP8	216	CRZC	230	ES24C	230	FRECO	234	ICCG	192
2139C	205	2620	224	2955	206	20006C	219	BP8C	216	CRZG	230	ES24G	230	FREM	233	ICCG	220
2139G	205	2621	224	2994	230	30001	220	BP8G	216	CRZM	230	ES27	230	FRS	195	ICCG	220
2143	205	2625	220	2994C	230	30006	219	BPC	201	CSP	187	ES33	231	FRS	225	ICI	220
2143C	205	2628	200	2994G	230	ADi	227	BPG	201	CSPB	187	ES35	230	FRSC	195	IMÁN	192
2143G	205	2646	214	3000	189	ASL	227	BR1M	212	CSPBC	187	ES35C	230	FRSC	225	iP	227
2147	224	2652	219	3000C	189	AST100	188	BRC	234	CSPBG	187	ES35G	230	FRSG	195	iPF	228
2148	224	2658	202	3000G	189	BA	205	BS35	208	CSPC	187	ES41	230	FRSG	225	iPL	227
2149	224	2665	198	3001	189	BA107	212	BS35C	208	CSPG	187	ES41C	230	FT6	221	iSL	227
2153	190	2692	188	3001C	189	BA183	212	BS35G	208	CT2	194	ES41G	230	FT6C	221	J100D	194
2191	219	2697	196	3001G	189	BA1M	212	BSL108	212	CT3	194	ES42	230	FT6R	221	J100T	194
2191R	219	2699	190	3005	200	BA207	212	BSL32	212	CTA2	194	ES49	231	G914	192	J115	197

CLAVE / PAG.		CLAVE / PAG.		CLAVE / PAG.		CLAVE / PAG.		CLAVE / PAG.		CLAVE / PAG.		CLAVE / PAG.			
J117	197	M3C	215	PLACA 33	234	PLACA 83	234	S521PG	218	TFM	228	VC12	222	VP9	222
J127	196	M3G	215	PLACA 34	234	PLACA 84	234	S80	186	TGP	213	VC12	223	VP9	223
J178	196	MB107	212	PLACA 35	234	PLACA 9	234	S80C	186	TGPC	213	VC13	222	VPC8	222
J208	197	MB33	212	PLACA 36	234	PS2	192	S80G	186	TGPG	213	VC13	223	VPC8	223
J213-30	196	MB57	212	PLACA 37	234	PS3	192	S924T	185	TH	227	VC177	223	VPZ	222
J213-45	196	MCR	191	PLACA 38	234	PS3D	192	S924TC	185	TJL	198	VC177P	222	VPZ	223
J213-60	196	ME12	219	PLACA 39	234	R	195	S924TG	185	TL3	228	VC177P	223	VPZP	222
J230	197	ME15	219	PLACA 4	234	R150D	219	SA	217	TL4	228	VCA	222	VPZP	223
J232	197	ME20	219	PLACA 40	234	R150i	219	SAA	217	TP70	193	VCA	223	VPZPR	222
J2D	194	ME200	219	PLACA 41	234	R42D	219	SAAC	217	TP80	193	VCA3	222	VR6	223
J2i	194	ME300	219	PLACA 42	234	R42i	219	SAAG	217	TPC	193	VCA3	223	VR6	223
J3D	194	MER	191	PLACA 43	234	RCO	219	SACR	217	TPCC	193	VCS	222	VR7	223
J3i	194	MP	215	PLACA 44	234	RGC	219	SC6P	186	TPCG	193	VCS	223	VR7	223
J70D	194	MPC	215	PLACA 45	234	S180	232	SC6PC	186	TPL	193	VG	222	VR8	223
J70T	194	MPG	215	PLACA 46	234	S2	192	SC6PG	186	TPLC	193	VG	223	VR8	223
J80D	194	MR35	215	PLACA 47	234	S2C	192	SHT	227	TPLG	193	VH	223	VR9	223
J80T	194	MR35C	215	PLACA 48	234	S2G	192	SM45E	191	TPM	228	VH	223	VR9	223
JC100	191	MR35G	215	PLACA 49	234	S3	192	SM45LL	191	TR100	193	VH14	223	VRE	222
JE12N	195	MS	237	PLACA 5	234	S395	185	SM45S	191	TR70	193	VH14R	223	VRE	223
JE12NC	195	MSO	190	PLACA 50	234	S395C	185	SME	190	TR80	193	VH14R	223	VU6P	222
JE12NG	195	MSR	191	PLACA 51	234	S395G	185	SMLL	190	TRi	237	VH4	223	VU6P	223
JE18N	195	MST	190	PLACA 52	234	S395P	185	SMS	190	TRJ	196	VH4R	223	VU6PR	222
JE18NC	195	MT2	215	PLACA 53	234	S395PC	185	STP	223	TRJ	197	VH4R	223	ZC4	227
JE18NG	195	MT2C	215	PLACA 54	234	S395PG	185	STP	223	TRS100	193	VH6	223	ZDL	227
JE246	189	MT2G	215	PLACA 55	234	S3C	192	STPR	223	TS	220	VH6R	223	ZE	228
JE246C	189	OBP	209	PLACA 56	234	S3D	192	T100	193	TT2	228	VH6R	223	ZEC	228
JE246G	189	OBP	209	PLACA 57	234	S3DC	192	T100CT	236	TT3	228	VHP	223	ZL	227
JE266	189	PH	236	PLACA 58	234	S3DG	192	T100J	236	TUJT	229	VHPR	223	ZSL	227
JE266C	189	PH10	236	PLACA 59	234	S3G	192	T1523	209	TZ100	230	VHPR	223	ZSL4	227
JE266G	189	PLACA 1	234	PLACA 6	234	S412	186	T1523C	209	U246	189	VM35	222	ZSL6	227
JE267	189	PLACA 10	234	PLACA 60	234	S412C	186	T1523G	209	U246C	189	VM35	223	ZYC	227
JE267C	189	PLACA 11	234	PLACA 61	234	S412G	186	T2CTT	236	U246G	189	VM40	222		
JE267G	189	PLACA 12	234	PLACA 62	234	S437	186	T2JRT	236	U246G	189	VM40	223		
JF12N	195	PLACA 13	234	PLACA 63	234	S437C	186	T3CTT	236	U911	191	VM45	222		
JGL	189	PLACA 14	234	PLACA 64	234	S437C	186	T3JRT	236	U911T	191	VM45	223		
JU263	189	PLACA 15	234	PLACA 65	234	S437G	186	T70	193	UC	214	VM50	222		
JU263C	189	PLACA 16	234	PLACA 66	234	S477	185	T70CT	236	UCR	191	VM50	223		
JU263G	189	PLACA 17	234	PLACA 67	234	S477C	185	T70J	236	V3	222	VP10	222		
K1909	208	PLACA 18	234	PLACA 68	234	S477G	185	T80	193	V3	223	VP10	223		
K1909C	208	PLACA 19	234	PLACA 69	234	S479	185	T80CT	236	V3R	222	VP11	222		
K1909G	208	PLACA 2	234	PLACA 7	234	S479C	185	T80J	236	V4	222	VP11	223		
KBS35	208	PLACA 20	234	PLACA 70	234	S479G	185	TC100	230	V4	223	VP12	222		
KBS35C	208	PLACA 21	234	PLACA 71	234	S479G	185	TCJT	229	V4R	222	VP12	223		
KBS35G	208	PLACA 22	234	PLACA 72	234	S479PC	185	TCP10	193	V5	222	VP13	222		
KJCR	191	PLACA 23	234	PLACA 73	234	S479PG	185	TCP10C	193	V5	223	VP13	223		
M14	215	PLACA 24	234	PLACA 74	234	S503P	186	TCP10G	193	V5R	222	VP14	222		
M14C	215	PLACA 25	234	PLACA 75	234	S503PC	186	TCP6	193	VA	223	VP14	223		
M14G	215	PLACA 26	234	PLACA 76	234	S503PG	186	TCP6C	193	VA	223	VP15	222		
M2	215	PLACA 27	234	PLACA 77	234	S504	186	TCP6G	193	VAP	223	VP15	223		
M2C	215	PLACA 28	234	PLACA 78	234	S504C	186	TCP8	193	VAPR	223	VP16	222		
M2G	215	PLACA 29	234	PLACA 79	234	S504G	186	TCP8C	193	VAPR	223	VP16	223		
M3	215	PLACA 3	234	PLACA 8	234	S504P	186	TCP8G	193	VC10	222	VP17	222		
M35	215	PLACA 30	234	PLACA 80	234	S504PC	186	TD	235	VC10	223	VP17	223		
M35C	215	PLACA 31	234	PLACA 81	234	S504PG	186	TF2	228	VC11	222	VP8	222		
M35G	215	PLACA 32	234	PLACA 82	234	S521P	218	TF3	228	VC11	223	VP8	223		

U-LIGHT / C-LIGHT

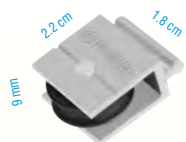

24 Pieza
24CC 50 Piezas
24CG 100 Piezas

Durabilidad en Ciclos:
50,000 con 8 Kg (Par)



Salmo Cuerpo de Aluminio Balero Importado

VENTANA LÍNEA 2"



S477 Pieza
S477C 50 Piezas
S477G 100 Piezas

Durabilidad en Ciclos:
910,000 con 20 Kg (Par)
410,000 con 35 Kg (Par)



477P Pieza
477PC 50 Piezas
477PG 100 Piezas

Durabilidad en Ciclos:
180,000 con 35 Kg (Par)



478 Pieza
478CC 50 Piezas
478CG 100 Piezas

Durabilidad en Ciclos:
165,000 con 15 Kg (Par)

PUERTA LÍNEA 2"

SUAVE DESPLAZAMIENTO



S395 Pieza
S395C 50 Piezas
S395G 100 Piezas

Durabilidad en Ciclos:
825,000 con 35 Kg (Par)
540,000 con 55 Kg (Par)



S395P Pieza
S395PC 50 Piezas
S395PG 100 Piezas

Durabilidad en Ciclos:
825,000 con 35 Kg (Par)
540,000 con 55 Kg (Par)

DURABILIDAD DE CARRETILLAS

APERTURA Y CIERRE DE 75 cm

AÑOS	APERTURAS DIARIAS	APERTURAS TOTALES
20	5	36,500
20	10	73,000
20	20	146,000
20	50	365,000
20	100	730,000
20	400	2,920,000

PUERTA LÍNEA 2"



1001 Pieza
1001CC 50 Piezas
1001CG 100 Piezas

Durabilidad en Ciclos:
263,000 con 35 Kg (Par)
53,000 con 55 Kg (Par)

VENTANA Y PUERTA CORREDIZA

LÍNEA 3", SERIE 70, 80 y 100

Cuerpo de Aluminio



S479A Pieza
S479AC 50 Piezas
S479AG 100 Piezas

Cuerpo de Aluminio



S479PA Pieza
S479PAC 50 Piezas
S479PAG 100 Piezas

SUAVE DESPLAZAMIENTO

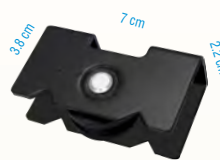

S479 Pieza
S479C 50 Piezas
S479G 100 Piezas

Durabilidad en Ciclos:
2,800,000 con 35 Kg (Par)

ALTO RENDIMIENTO

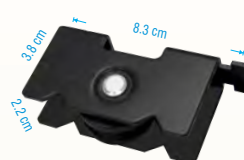

S479P Pieza
S479PC 50 Piezas
S479PG 100 Piezas

Durabilidad en Ciclos:
2,800,000 con 35 Kg (Par)



S924 Pieza
S924C 30 Piezas
S924G 60 Piezas



S924T Pieza
S924TC 40 Piezas
S924TG 80 Piezas

Durabilidad en Ciclos:
2,800,000 con 35 Kg (Par)

Probadas en Nuestro Centro de Investigación y Desarrollo con Ciclos de 75 cm de Apertura

VENTANA Y PUERTA CORREDIZA LINEA 3", SERIE 70, 80 y 100

Perfiletto
ALUMINUM



S412 Pieza
S412C 30 Piezas
S412G 60 Piezas

Durabilidad en Ciclos:
2,500,000 con 55 Kg (Par)
1,100,000 con 75 Kg (Par)

SUAVE DESPLAZAMIENTO

NUEVO



S80 Pieza
S80C 30 Piezas
S80G 60 Piezas

Durabilidad en Ciclos:
3,500,000 con 35 Kg (Par)
3,000,000 con 55 Kg (Par)
2,500,000 con 75 Kg (Par)

CUERPO DE ALUMINIO EXTRUIDO AJUSTABLE

Exclusiva Rieles Sencillos a Piso

Rodaja 1 1/2"



6 RODAJAS SISTEMA TANDEM

Salino



SUAVE DESPLAZAMIENTO

SC6P Pieza
SC6PC 10 Piezas
SC6PG 20 Piezas

Durabilidad en Ciclos:
2,000,000 con 115 Kg (Par)
1,200,000 con 180 Kg (Par)

DURABILIDAD DE CARRETILLAS APERTURA Y CIERRE DE 75 cm

AÑOS	APERTURAS DIARIAS	APERTURAS TOTALES
20	5	36,500
20	10	73,000
20	20	146,000
20	50	365,000
20	100	730,000
20	400	2,920,000



S437 Pieza
S437C 30 Piezas
S437G 60 Piezas

Durabilidad en Ciclos:
4,200,000 con 35 Kg (Par)
4,060,000 con 55 Kg (Par)

MOSQUITERO CORREDIZO

INFERIOR NUEVO



S503P Pieza
S503PC 50 Piezas
S503PG 100 Piezas

PRUEBAS EFECTUADAS
Durabilidad en Ciclos:
2,500,000 con 3.5 Kg (Par)



Acero Inoxidable 430
Rápido Armado
Diseñada para Perfiles
76533, R66533 y R6533
No Requiere Carretilla Superior

INFERIOR NUEVO

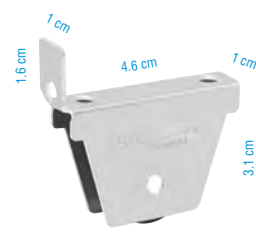

S504P Pieza
S504PC 50 Piezas
S504PG 100 Piezas

PRUEBAS EFECTUADAS
Durabilidad en Ciclos:
3,600,000 con 3.5 Kg (Par)



Rápido Armado

Perfiletto
ALUMINUM

Rodaja Embalada
Ø 27 mm
Fleje

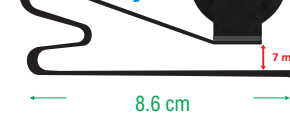

655P Pieza
655PC 50 Piezas
655PG 100 Piezas

SUPERIOR



Firmeza y Deslizamiento Suave al Mosquitero

INFERIOR NUEVO



S504 Pieza
S504C 50 Piezas
S504G 100 Piezas

PRUEBAS EFECTUADAS
Durabilidad en Ciclos:
1,800,000 con 3.5 Kg (Par)

CARRETILLA RIEL SUPERIOR 5081 CORREDIZAS Y PLEGABLES

JUEGO CARRETILLA Y BARRA DE ALUMINIO

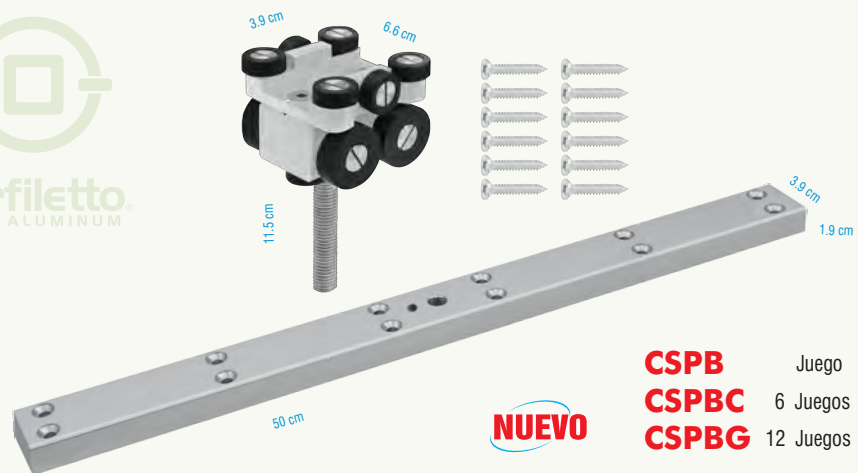

NUEVO

CSPB Juego
CSPBC 6 Juegos
CSPBG 12 Juegos

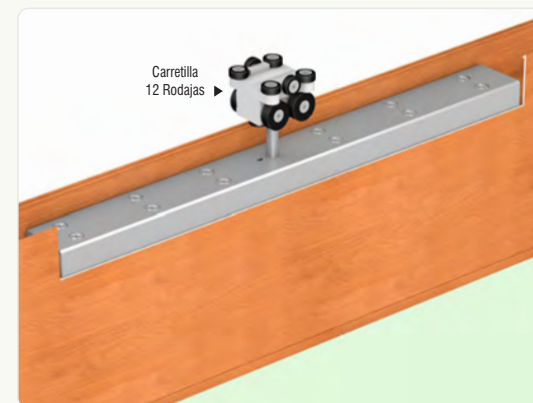
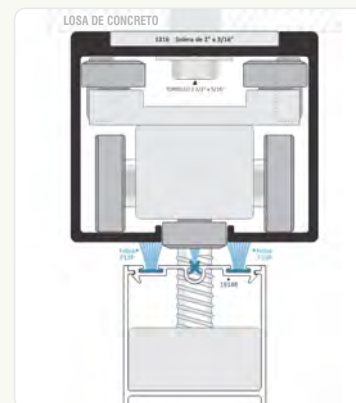

PIEZAS DE REEMPLAZO



CARRETILLA DE 12 RODAJAS

CSP Pieza
CSPC 6 Piezas
CSPG 12 Piezas



BSP Pieza
 Barra Sistema Plegadizo

VENTANA 2"



1288T
 Technica

Prueba Efectuada con :
15 Kg 90,000 Ciclos

VENTANA 3"

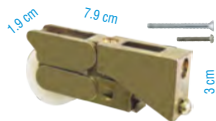

21
 Zamak Ajustable

Prueba Efectuada con :
35 Kg 46,000 Ciclos
55 Kg 32,000 Ciclos
75 Kg 17,000 Ciclos

LÍNEA 3"

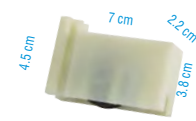

1563
 Cuerpo Plástico
 Ensamble rápido

Prueba Efectuada con :
35 Kg 112,000 Ciclos
55 Kg 62,000 Ciclos

MOSQUITERO CORREDIZO

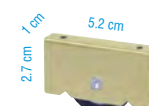

1438
 Importada
 Balero Grande

Prueba Efectuada con :
3.5 Kg 3,000,000 Ciclos



402
 Española Fija

Prueba Efectuada con :
35 Kg 253,000 Ciclos
55 Kg 124,000 Ciclos



2099
 Zamak Ajustable

Prueba Efectuada con :
35 Kg 362,000 Ciclos
55 Kg 210,000 Ciclos
75 Kg 126,000 Ciclos

RODAJA DOBLE



53
 Truth Ajustable

Prueba Efectuada con :
55 Kg 365,000 Ciclos
75 Kg 234,000 Ciclos



VENTANA PANORÁMICA SERIE 100



RIEL SUPERIOR

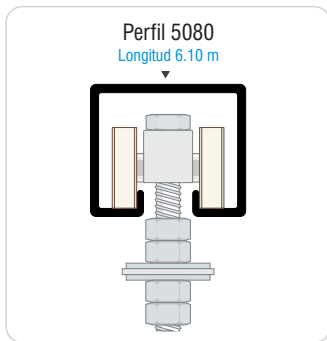

Diseñada para Riel 5080 Perfiletto

534P Pieza
534PC 10 Piezas
534PG 20 Piezas

Prueba Efectuada con :
Durabilidad en Ciclos
100 Kg 935,000 Ciclos Par

Suave Deslizamiento 4 Baleros



2 Baleros

2280
Pieza

Soporta 50 Kg par

RIEL SUPERIOR 5080

2692
6 baleros

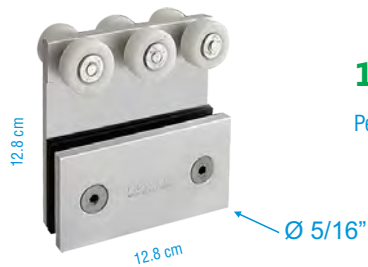

Soporta 100 Kg par

Perforación al Cristal
Rodaja Ø 3 cm

"Gleiro"

762
4 Rodajas

Soporta 5 Kg par



Perfil 3312
Longitud 6.10 m

Soporte para ganchos

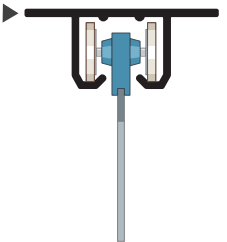

MOSQUITERO COLGANTE

396
Embalada



Prueba Efectuada con :
3.5 Kg 4,800,000 Ciclos

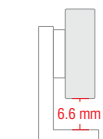

630
Embalada

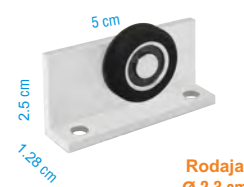

Prueba Efectuada con :
3.5 Kg 3,100,000 Ciclos

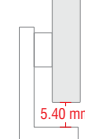

Salino 19E



Prueba Efectuada con :
3.5 Kg 1,200,000 Ciclos

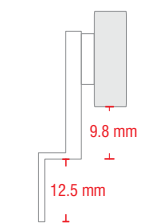

SERIE 17.5

LÍNEAS: U Light, C Light, 2" y 3"

LÍNEA: 3"

Gancho Integrado Uso Rudo Contra y Pijas al color de la Jaladera

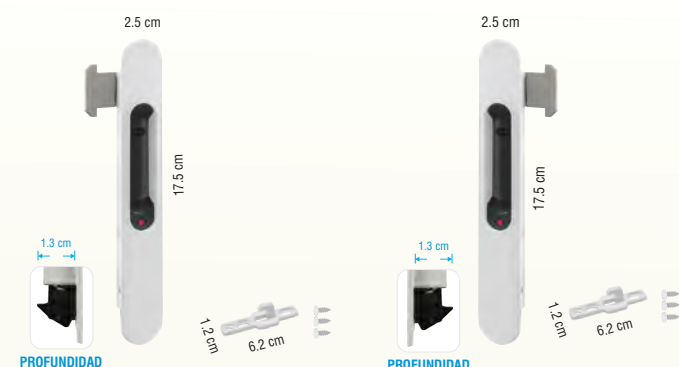

IZQUIERDA

DERECHA

- 3000** Pieza
- 3000C** 20 Piezas
- 3000G** 40 Piezas

- 3001** Pieza
- 3001C** 20 Piezas
- 3001G** 40 Piezas



UÑERO

- JU263** Pieza
- JU263C** 25 Piezas
- JU263G** 50 Piezas

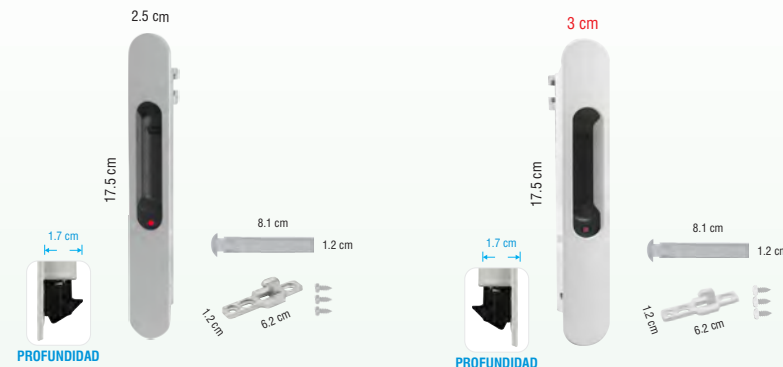

PROFUNDIDAD

PROFUNDIDAD

- JE267** Pieza
- JE267C** 20 Piezas
- JE267G** 40 Piezas



- JE266** Pieza
- JE266C** 20 Piezas
- JE266G** 40 Piezas



CONTRAS

SERIE 70 Y 80

2564 Pieza

Fijación con Opresor
Sin Perforar el Perfil

SERIE 100

C100P Pieza

C100PC 50 Piezas

C100PG 100 Piezas

Fijación con Opresor Sin Perforar el Perfil

U LIGHT/ C LIGHT, 2" y 3"

3102 Pieza

3102C 20 Piezas

3102G 40 Piezas

1171 Pieza

GANCHOS DE REEMPLAZO

G914

Pieza Reemplazo

Broche Embutir 914

GB

Pieza Reemplazo

Broche Embutir 2827

GL Pieza

GLC 50 Piezas

GLG 100 Piezas

GM Pieza

GMC 50 Piezas

GMG 100 Piezas

GLE Pieza

GLEC 50 Piezas

GLEG 100 Piezas

Extra Largo

SERIE 19.5

LÍNEAS: 3"

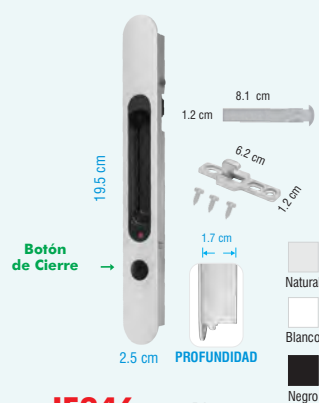

JE246 Pieza
JE246C 25 Piezas
JE246G 50 Piezas

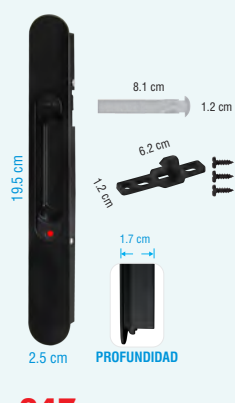
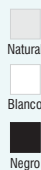

247 Pieza
247C 25 Piezas
247G 50 Piezas



CIERRE CON LLAVE
245 Pieza
245C 25 Piezas
245G 50 Piezas

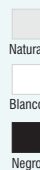

LÍNEAS: 70 Y 80

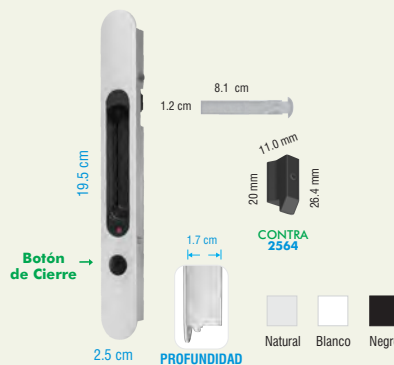

JE246-78 Pieza
JE246-78C 25 Piezas
JE246-78G 50 Piezas



247-78 Pieza
247-78C 25 Piezas
247-78G 50 Piezas



UÑERO SERIE 19.5



CON ALA DERECHA
3101 Pieza
3101C 25 Piezas
3101G 50 Piezas

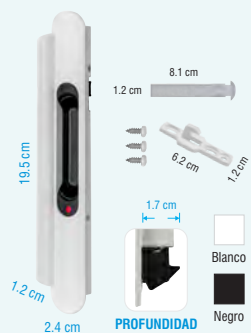
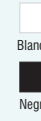

CON ALA IZQUIERDA
3100 Pieza
3100C 25 Piezas
3100G 50 Piezas

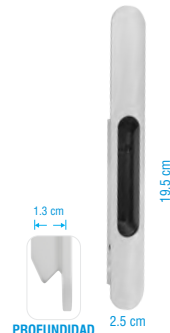

U246 Pieza
U246C 25 Piezas
U246G 50 Piezas

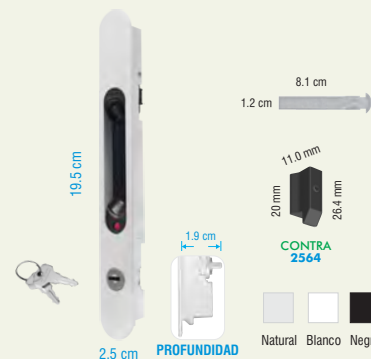

CIERRE CON LLAVE
245-78 Pieza
245-78C 25 Piezas
245-78G 50 Piezas



244 Pieza
244C 12 Piezas
244G 24 Piezas

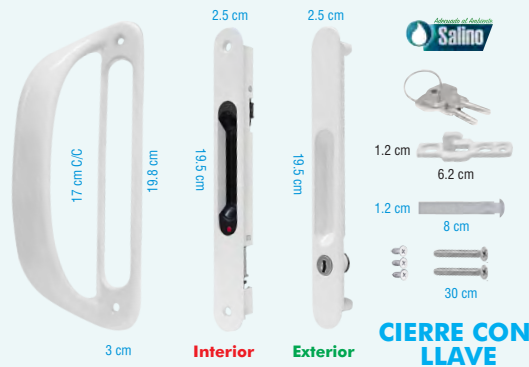
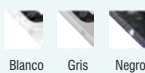

244S Pieza
244SC 12 Piezas
244SG 24 Piezas

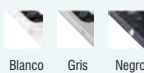

244-78 Pieza
244-78C 12 Piezas
244-78G 24 Piezas

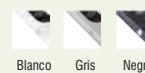

244S-78 Pieza
244S-78C 12 Piezas
244S-78G 24 Piezas

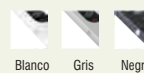

LÍNEAS: SERIE 100

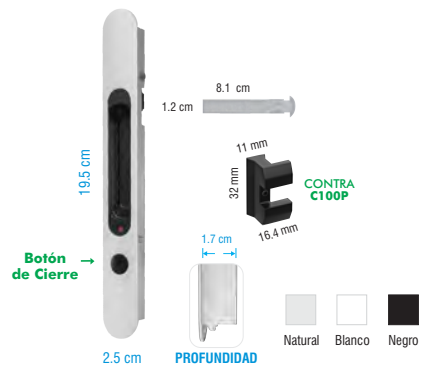

- JE246-1** Pieza
- JE246C-1C** 25 Piezas
- JE246G-1G** 50 Piezas



- 247-1** Pieza
- 247C-1C** 25 Piezas
- 247G-1G** 50 Piezas



- CIERRE CON LLAVE**
- 245-1** Pieza
 - 245-1C** 25 Piezas
 - 245-1G** 50 Piezas



- 244-1** Pieza
- 244-1C** 12 Piezas
- 244-1G** 24 Piezas



- 244S-1** Pieza
- 244S-1C** 12 Piezas
- 244S-1G** 24 Piezas

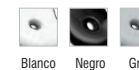

JALADERA SOBREPONER



- 3107** Pieza
- 3107C** 10 Piezas
- 3107G** 20 Piezas

UÑERO

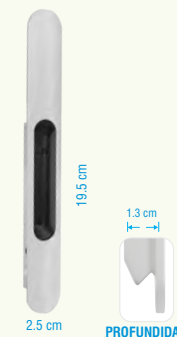

- U246** Pieza
- U246C** 25 Piezas
- U246G** 50 Piezas



Perfiletto
ALUMINUM

Bloqueo con Llave Fijación Invisible

LÍNEAS 2" Y 3"

2827 Pieza
2827C 30 Piezas
2827G 60 Piezas

PROFUNDIDAD 2.4 cm

Natural Blanco Negro

Salino

Perfiletto
ALUMINUM

LÍNEAS 2" Y 3"

914 Pieza
914PC 30 Piezas
914PG 60 Piezas

PROFUNDIDAD 2.4 cm

Blanco Gris Negro Hueso

- Pijas, Remaches y Contra al Color de la Jaladera
- Contra Reforzada de 3 Pijas
- Gancho con Curva Cierre Suave
- Cierre Automático

CIERRE AUTOMÁTICO

LÍNEA 2"

913

Blanco Gris
Café Negro

LÍNEA 2"

2699

Blanco Gris
Café Negro
Hueso

LÍNEA 3"

2240

Blanco Natural
Café Negro
Hueso

LÍNEA 3"

894

Blanco Gris
Café Negro
Hueso

LÍNEA 3"

2153

Blanco Natural
Café Negro
Hueso

LÍNEA 3"

894H

Blanco Gris
Café Negro

UÑEROS

643
Metal

Blanco Gris Negro

2316
Plástico

Blanco Negro

26E
Plástico

Blanco Negro

FIJACIÓN VISIBLE CIERRE MANUAL

Salino

LÍNEA 2"

3095

Blanco Gris Hueso Café Negro

LÍNEA 3"

3094

Blanco Gris Hueso Café Negro

CIERRE AUTOMÁTICO

NUEVO

LÍNEA 3"

910
Broche Embutir

Blanco Negro

ROTO SISTEMA MULTIPUNTO CON CREMONA DE 22 mm

Manija con Llave

SMLL Juegos Negro Blanco
SMLLC 4 Juegos
SMLLG 8 Juegos

Dimensions: 2.8 cm, 6.5 cm, 12.3 cm, 24 cm, 1.5 cm, 9.8 cm, 1.3 cm, 22 mm, 9.5 mm

Manija sin Llave

SMS Juegos Blanco Plata Negro
SMSC 4 Juegos
SMSCG 8 Juegos

Dimensions: 2.8 cm, 6.5 cm, 12.3 cm, 24 cm, 1.5 cm, 9.8 cm, 1.3 cm, 22 mm, 9.5 mm

Manija Embutida

SME Juegos Blanco Gris Negro
SMCEC 4 Juegos
SMCEG 8 Juegos

Dimensions: 3.2 cm, 14.1 cm, 24 cm, 1.5 cm, 9.8 cm, 1.3 cm, 22 mm, 8 mm

MOC2P
Manija sin Llave

Dimensions: 3.2 cm, 6.9 cm, 13.6 cm, 1.5 cm, 9.8 cm, 1.3 cm, 24 cm, 2.2 cm, 22 mm

MRC2P
Manija sin Llave

Dimensions: 3.2 cm, 6.9 cm, 13.4 cm, 1.5 cm, 9.8 cm, 1.3 cm, 24 cm, 2.2 cm, 22 mm

COMBINABLES CON SISTEMA MULTIPUNTO
CREMONAS: 22 mm y 45 mm

MSO
Manija sin Llave
Chapetón Ovalado

Acero Inoxidable

Dimensions: 3.2 cm, 6.9 cm, 13.6 cm, 2.2 cm

MST
Manija sin Llave
Chapetón Rectangular

Acero Inoxidable

Dimensions: 3.2 cm, 6.9 cm, 13.4 cm, 2.2 cm

Manija con Llave

SM45LL Juegos
SM45LLC 4 Juegos
SM45LLG 8 Juegos

Blanco Plata Negro

Cremona 45 mm

Mayor Espacio

Manija 30 mm

Uñero

Manija

Manija sin Llave

SM45S Juegos
SM45SC 4 Juegos
SM45SG 8 Juegos

Blanco Plata Negro

Cremona 45 mm

Mayor Espacio

Manija 30 mm

Uñero

Manija

Manija Embutida

SM45E Juegos
SM45EC 4 Juegos
SM45EG 8 Juegos

Blanco Gris Negro

Cremona 45 mm

Mayor Espacio

Manija Embutida 30 mm

Uñero

Manija Embutida

Jaladera Tirador

KJCR Negro

Cremona 45 mm

Mayor Espacio

30 mm

Uñero

Jaladera

Manija sin Llave

MOC4P

Cremona 45 mm

Mayor Espacio

23.6 mm

Manija sin Llave

MRC4P

Cremona 45 mm

Mayor Espacio

24 mm

Manija sin Llave

MOC4G

Cremona 45 mm

Mayor Espacio

28.2 mm

Manija sin Llave

MRC4G

Cremona 45 mm

Mayor Espacio

28.5 mm

JALADERA BROCHE DE EMBUTIR



UÑERO



JALADERA TIRADOR



UCR

PIEZAS REEMPLAZO

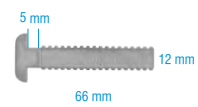

GRL Pieza
GRLC 20 Piezas
GRLG 50 Piezas



TAPAS laterales SIFÓN

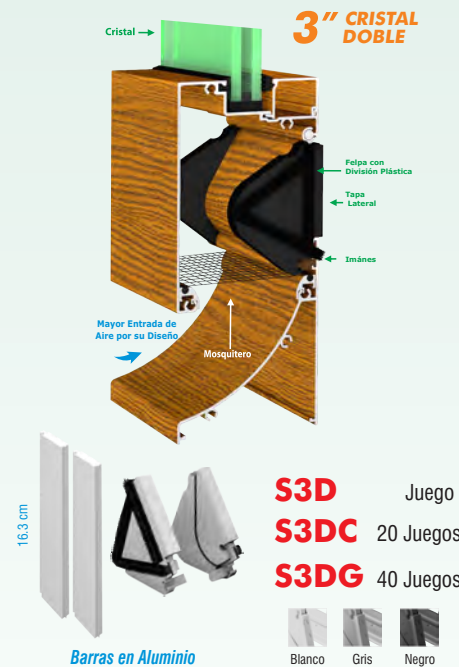
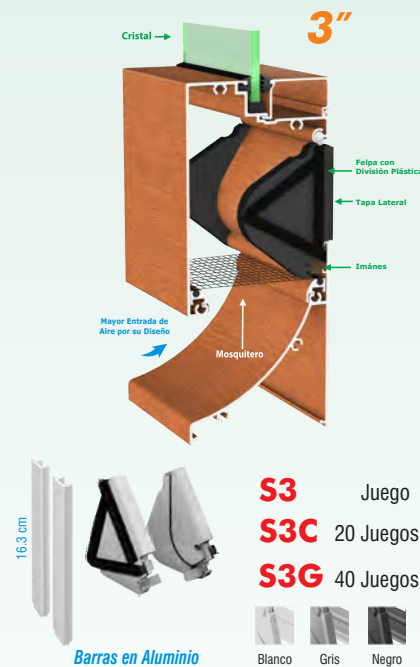

GRAN HERMETICIDAD
HASTA 200 km / h

Cierre más Hermético
por sus Felpas e Imanes

Ancho Máximo Sugerido
por cajón : 1.50 m

IMÁN



SOPORTES SIFÓN

Listos para Ensamblar, Pintables en Nuestros Acabados





TPL Pieza
TPLC 500 Piezas
TPLG 1000 Piezas

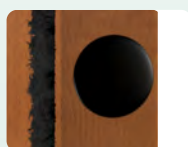

Estético



TPC Pieza
TPCC 500 Piezas
TPCG 1000 Piezas

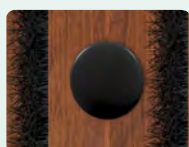

Esbelto



16E Pieza
16EC 100 Piezas
16EG 1000 Piezas

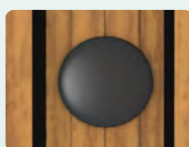
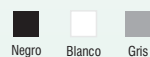

Sencillo



TCP6 Pieza
TCP6C 500 Piezas
TCP6G 1000 Piezas

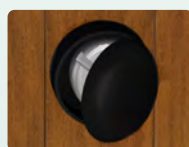

Cubre Pija # 6



TCP8 Pieza
TCP8C 500 Piezas
TCP8G 1000 Piezas

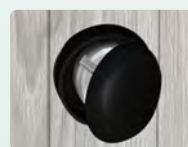

Cubre Pija # 8



TCP10 Pieza
TCP10C 500 Piezas
TCP10G 1000 Piezas

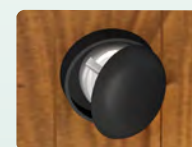
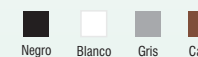

Cubre Pija # 10



2TCP Pieza
2TCP C 500 Piezas
2TCP G 1000 Piezas



Cubre Pijas #10



TOPES LÍNEAS CORREDIZAS



SERIE 70

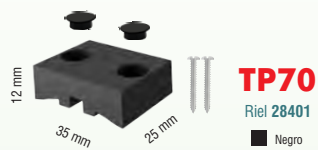

TP70
 Riel 28401
 Negro



T70
 Riel Superior 28402
 Negro



NUEVO

TR70
 Riel 628407, 628407D,
 662373 y 662373D
 Negro



SERIE 80

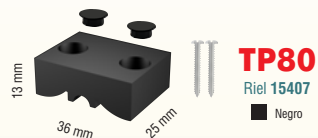

TP80
 Riel 15407
 Negro

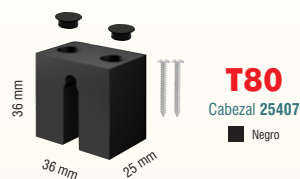

T80
 Cabezal 25407
 Negro



NUEVO

TR80
 Riel 638407, 638407D,
 648407 y 648407D
 Negro



SERIE 100



T100
 Riel 15231
 Negro



TR100
 Riel 23578, 34715
 Negro

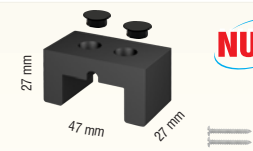

TRS100
 Riel 23578, 23578DREN,
 34715, 34715DREN,
 15230 y 25230

NUEVO



Probadas en Nuestro Centro de Investigación y Desarrollo con Excelente Sello al Agua

LINEA 2" Derechas

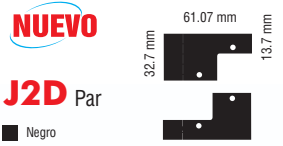

LINEA 2" Izquierdas

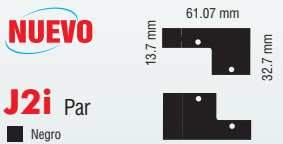

LINEA 3" Derechas

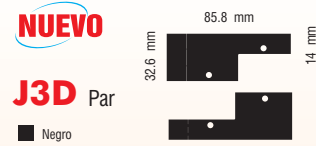

LINEA 3" Izquierdas



SERIE 70

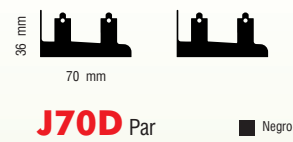

SERIE 70 TRIPLE

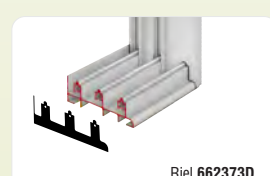
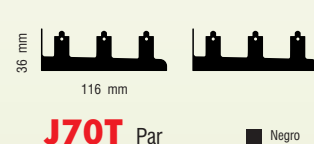

SERIE 80

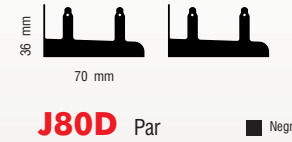

SERIE 80 TRIPLE

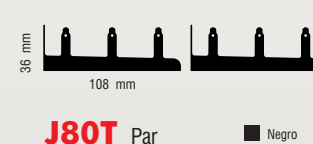

SERIE 100

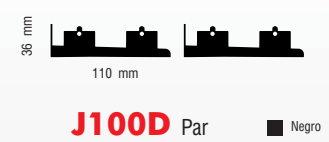

SERIE 100 TRIPLE

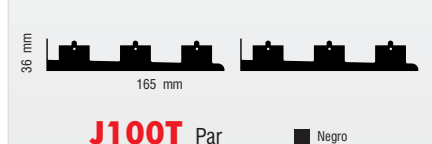

CUBIERTAS TRASLAPE



ALUMINIO



Ventana y Puerta Línea 2"
Cubiertas Traslape

CTA2 Par
CTA2C 60 Pares
CTA2G 120 Pares

Ventana y Puerta Línea 3"
Cubiertas Traslape

CTA3 Par
CTA3C 60 Pares
CTA3G 120 Pares

PLÁSTICO



Ventana y Puerta Línea 2"
Cubiertas Traslape

CT2 Par
Gris Negro

Ventana y Puerta Línea 3"
Cubiertas Traslape

CT3 Par
Gris Negro



SERIE 70



SERIE 100



TAPAS

Estrizada 11 cm



- 42** Pieza
- 42C** 30 Piezas
- 42G** 60 Piezas

Mecanismo en Plástico



Estrizada 12 cm

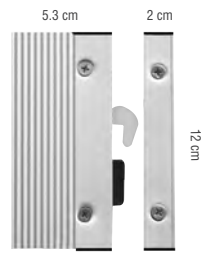

- JE12N** Pieza
- JE12NC** 30 Piezas
- JE12NG** 60 Piezas

Mecanismo en Plástico



Estrizada 18 cm



- JE18N** Pieza
- JE18NC** 30 Piezas
- JE18NG** 60 Piezas

Mecanismo en Plástico



Formaica 12 cm



- JF12N** Pieza

Mecanismo en Plástico



AUMENTE SU PRESTIGIO
FIJACIÓN USO RUDO

R
Remachadora
2 Boquillas

Remaches y Tornillos con Rosca de Alta Resistencia

FRS Juego
FRSC 10 Juegos
FRSG 20 Juegos

Remaches Roscados y Tornillos Allen en Acero Inoxidable



- 2238** 12 cm
-



- 2236** 18 cm
-



- 2248** 18 cm
-

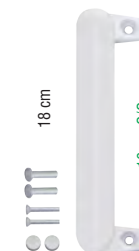

- 1404H** Zamak
-

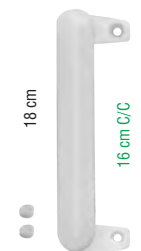

- 1404** Zamak
-



- 2239** Aluminio
-



- Fijar con Juego FRS**
- 20E** Sobreponer
-

TIRADOR DE SEGURIDAD EN CORREDIZAS

LÍNEA 3", SERIE 70 y 80

SERIE 100



- 1479** Seguro Tirador Corto
-

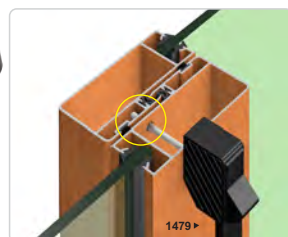

- 1479L** Seguro Tirador Largo
-

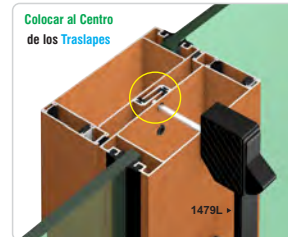

JALADERA TROMPA DE ELEFANTE

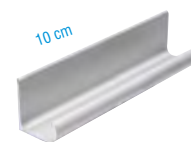

- 249R** Pieza
-

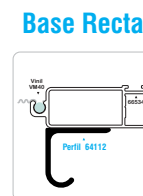

JALADERA C-LIGHT

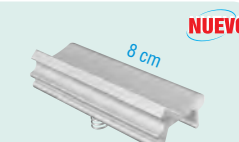

- Incluye Resorte Remachado
- 190** Pieza
-

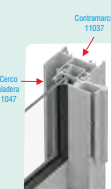

JALADERA U-LIGHT/ C-LIGHT



- 189** Pieza
-



Agregar a la Clave: **C** Caja 4 piezas "o" **G** caja 8 piezas



CLAVE	Y	D	P	C/C	X
J213-30	30 cm	Ø 3.7 cm	Ø 3/8"	20 cm	4.5 cm
2697	45 cm	Ø 2.4 cm	Ø 3/8"	30.5 cm	3.7 cm
J213-45	45 cm	Ø 3.7 cm	Ø 3/8"	30 cm	4.1 cm
2022	50 cm	Ø 3.1 cm	Ø 3/8"	30 cm	4.7 cm
2278	50 cm	Ø 3.1 cm	Ø 3/8"	35 cm	4.8 cm
J213-60	60 cm	Ø 3.7 cm	Ø 3/8"	40 cm	4.1 cm
2861	65 cm	Ø 3.1 cm	Ø 1/2"	45 cm	4.4 cm
2903	80 cm	Ø 2.9 cm	Ø 1/2"	60 cm	4.4 cm
2400	100 cm	Ø 3.1 cm	Ø 5/16"	80 cm	4.2 cm
3057	120 cm	Ø 3.1 cm	Ø 3/8"	80 cm	4.5 cm
2422	150 cm	Ø 3.2 cm	Ø 3/8"	100 cm	4.5 cm



JUEGO DE JALADERA SIMBOLOGÍA



2873

Y	45 cm
D	Ø 2.4 cm
P	Ø 5/16"
C/C	30 cm
X	3.2 cm

Satín con Cromo



J127

Y	60 cm
D	Ø 3.2 cm
P	Ø 3/8"
X	4.2 cm

Ajustable



J178

Y	50 cm
D1	Ø 3 cm
D2	Ø 4 cm
P	Ø 3/8"
C/C	40 cm
X	4.1 cm

Tornillos 5/16"

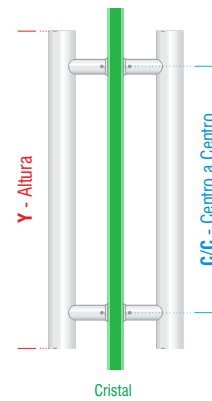

Vista Superior

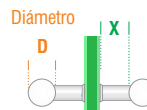

D1 Diámetro



P - Perforación

D2 Diámetro



2874

Y	45 cm
D	Ø 2.4 cm
P	Ø 5/16"
C/C	30 cm
X	4.3 cm

Satín Cromo



2945

Y	50 cm
D	Ø 2.5 cm
P	Ø 3/8"
C/C	30 cm
X	4.1 cm

Tornillos 5/16"



TRJ

Tornillos 5/16"
Par

Instalación en Aluminio



2023

Y	38 cm
D	Ø 3 cm
P	Ø 3/8"
C/C	30 cm
X	3.4 cm

Tornillos 5/16"



Agregar a la Clave: **C** Caja 4 piezas "o" **G** caja 8 piezas

JUEGO DE JALADERA SIMBOLOGÍA



J208

Y	45 cm
D1	2.2 cm
D2	3.14 cm
P	3/8"
C/C	42 cm
X	4.5 cm



2728

Y	30 cm
C/C	27.5 cm
X	6.9 cm
D	2.5 cm
P	3/8"



J230

Y	19.8 cm
C/C	17 cm
X	4 cm
D	2.5 cm
P	3/8"



J232

Y	20 cm
C/C	17.5 cm
X	10.5 cm
D	2.5 cm
P	3/8"



3105

Y	39.5 cm
D	3 cm
P	3/8"
C/C	31 cm
X	2.5 cm



Sencilla



J115

Y	50 cm
D	3.2 cm
P	3/8"
C/C	47 cm
X	7.2 cm



2033

Y	35.8 cm
D	Ø 2.5 cm
P	Ø 3/8"
C/C	30 cm
X	3.5 cm



Vista Superior

D Diámetro

X

D1 Diámetro

D2 Diámetro

Y - Altura

C/C - Centro a Centro

Cristal

P - Perforación

TRJ
Tornillos 5/16"
Par

8.1 cm

Instalación en Aluminio



J117

Y	60 cm
D1	2.5 cm
D2	3.8 cm
P	3/8"
C/C	56.5 cm
X	5 cm



1151

Y	17 cm
D	2.5 cm
P	3/8"
C/C	15 cm
X	4.5 cm



1476

Y	30 cm
D	2.5 cm
P	3/8"
C/C	27.5 cm
X	4.5 cm



2719

Y	33.5 cm
D	3 cm
P	3/8"
C/C	30.5 cm
X	4.5 cm



2029

Y	27 cm
D	2 cm
P	3/8"
C/C	25 cm
X	3.8 cm



1442

Y	30 cm
D	2.5 cm
P	3/8"
C/C	27 cm
X	5 cm



Y	34 cm
D	3.2 cm
P	3/8"
C/C	30.5 cm
X	5 cm



2720
Pieza

2720C
6 Piezas

2720G
12 Piezas

CON CERRADURA INTEGRADA

JUEGO DE JALADERA SIMBOLOGÍA

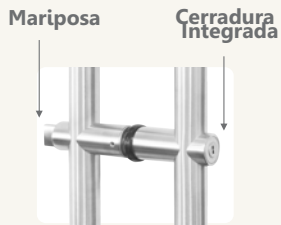

3126

Y	150 cm
D	3.5 cm
PS	1"
Pi	5/8"
C/C	112.5 cm
X	8.3 cm



Acero Inoxidable

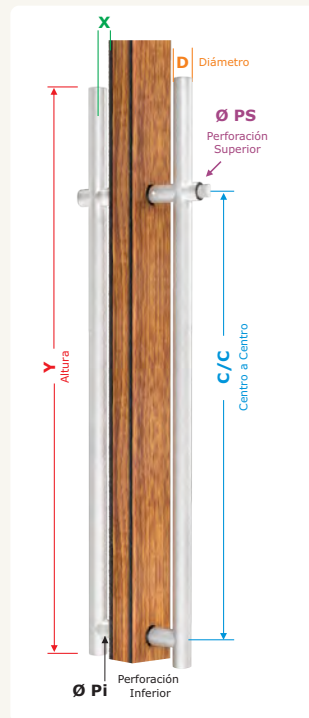
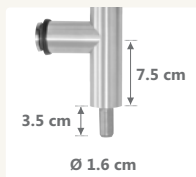

Instalación en Aluminio



TJL

Fijación jaladera Larga 3126

Instalación de Tornillos TJL

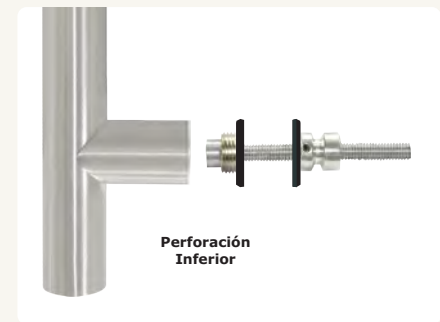

ACERO INOXIDABLE

SIMBOLOGÍA DE JALADERA

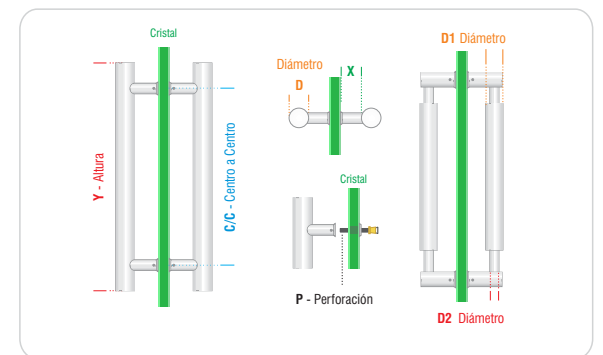
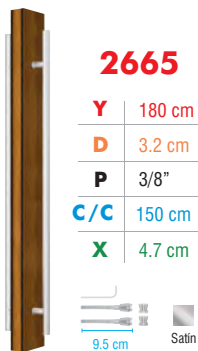

CONCHA

Estriada

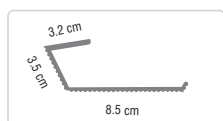

1492 20 cm
58 25 cm



CONTRAPLANA

6.3 cm
397 Plana (12 cm)

367 Plana (18 cm)

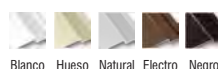

Fijación Invisible



1964
Jaladera



Pintado y Sublimado en Nuestros Acabados



Escolares

1,000,000 CICLOS

Resbalón y Contra Resistentes a la Corrosión

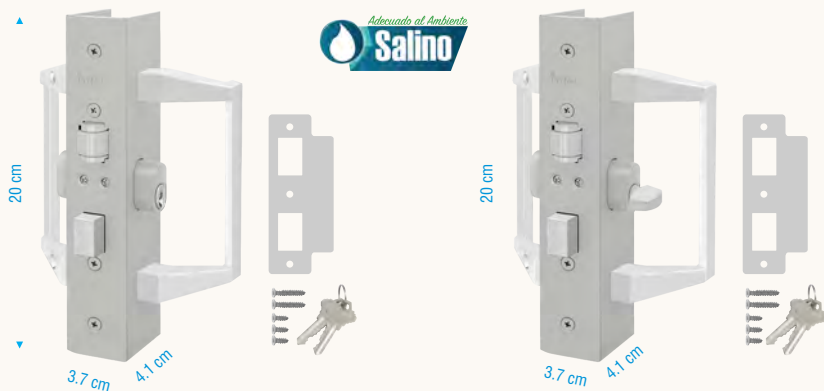

Llave- Llave

- 1089P** Pieza
- 1089PC** 6 Piezas
- 1089PG** 12 Piezas



Llave- Mariposa

- 472P** Pieza
- 472PC** 6 Piezas
- 472PG** 12 Piezas



Doble Manija

640,000 CICLOS

2,201,000 CICLOS

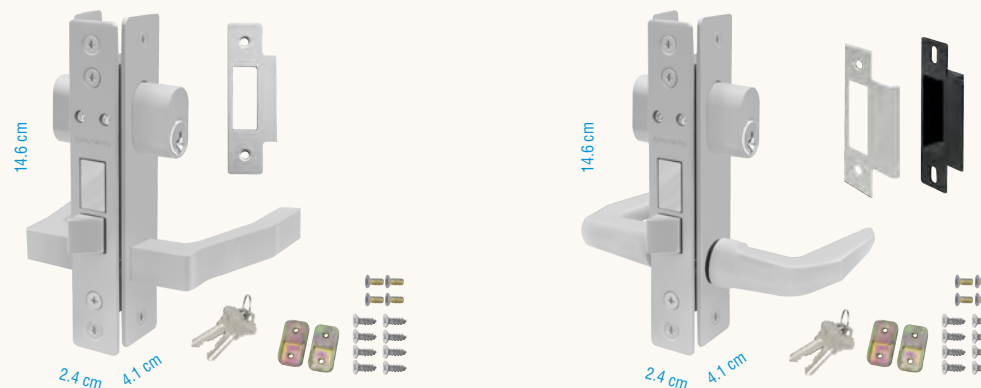

Llave- Llave

- 484P** Pieza
- 484PC** 6 Piezas
- 484PG** 12 Piezas



Llave- Llave

- 2003P** Pieza
- 2003PC** 6 Piezas
- 2003PG** 12 Piezas



CHAPA PREMIUM ALTO RENDIMIENTO 549P

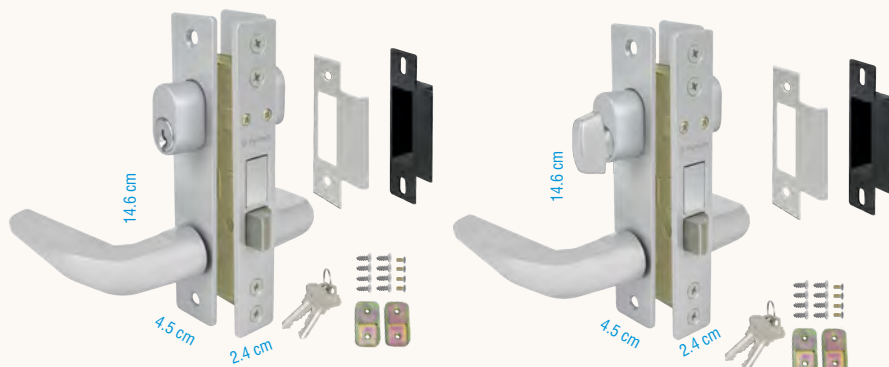

Llave- Llave

- 549P** Pieza
- 549PC** 6 Piezas
- 549PG** 12 Piezas

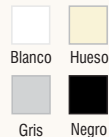

Llave- Mariposa

- 549PM** Pieza
- 549PMC** 6 Piezas
- 549PMG** 12 Piezas



2,201,000 CICLOS USO RUDO



Manijas uso Rudo Reforzadas



Otras

Ajustable en Dos Anchos de Perfiles :

- 9236, 17847,
- 79203, 79204, 69204, 9204, 46901, 412540, 412542, 412544, 412545



Tornillo Allen de Acero

Rosca de Alta Resistencia

Realiza Roscado en Manija

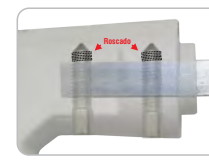

Barra de Acero



Tornillo Allen de Acero

Asegurando Fijación del Tornillo Allen en Manija



Mayor Espacio entre Chapa y Batiente

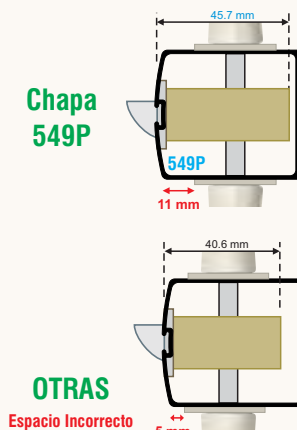

Chapa 549P

OTRAS

Espacio Incorrecto

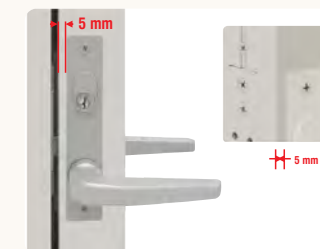

Cubierta Plástica

Oculta el Corte del Contramarco y el Fondo del Muro



Nueva Contra Curva Logrando Cierre Suave



Chapa 549P

Cerco Chapa

Cerco Chapa

LLAVE - LLAVE



2003



Durabilidad en Ciclos:
658,000 CICLOS

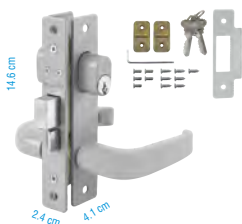

3005



Durabilidad en Ciclos:
140,000 CICLOS

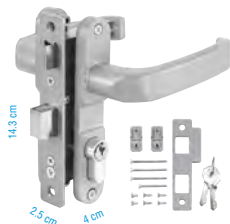

1449



Durabilidad en Ciclos:
650,000 CICLOS

LLAVE - LLAVE

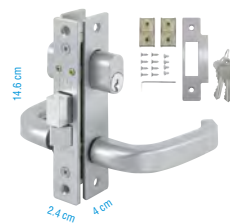

1730NM Pieza
1730NMC 6 Piezas
1730NMG 12 Piezas



Durabilidad en Ciclos:
185,000 CICLOS

LLAVE - MARIPOSA

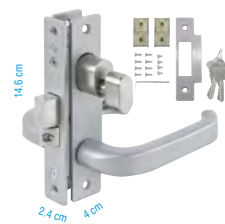

1730MC Pieza
1730MCC 6 Piezas
1730MCG 12 Piezas



LLAVE - LLAVE



484DC



Durabilidad en Ciclos:
1,000,000 CICLOS

LLAVE - MARIPOSA

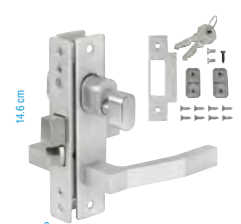

484MC



PIEZA REEMPLAZO



1936

Cilindro Mariposa
Adaptable a: 1730NM,
2003P y 484P

ESCOLARES

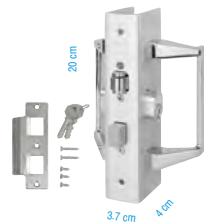

1089
Llave - Llave

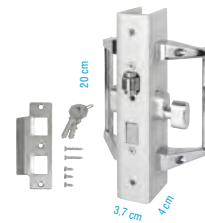

472
Llave - Mariposa



JALADERA - MANIJA



458

Llave - Llave



DOBLE CILINDRO

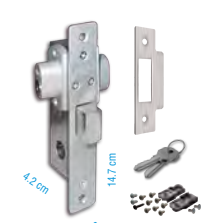

462

Llave - Llave



PALETA Llave - Llave



326 Pieza
326C 6 Piezas
326G 12 Piezas



GANCHO Llave Tetra

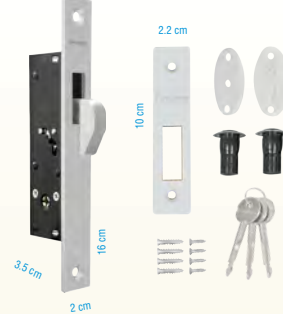

1036 Pieza
1036C 6 Piezas
1036G 12 Piezas

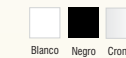

PALETA



1036P
Llave Tetra

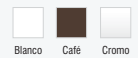

2628

NUEVO



Corrediza de 3" y
Puertas Batientes



1024

Recomendada
para: 7847 / 67847

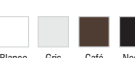

GANCHO



1429

Recomendada para:
11048, 67821, 7821, 7847 y 67847

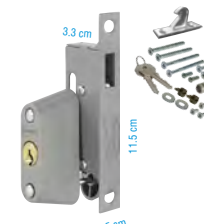

1410

Recomendada en Perfiles:
11048, 67821, 7821, 7847 y 67847



383



460

Recomendada
para: 7847 / 67847



185

Recomendada
para: 17847



1394

Recomendada para:
11048, 67821, 7821, 7847 y 67847

Llave - Mariposa

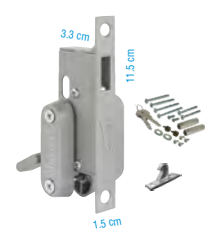

PERILLA - JALADERA

1633

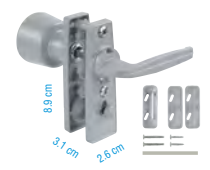



ALTO RENDIMIENTO, RESISTENCIA AL AMBIENTE SALINO Y MAYOR SEGURIDAD 4,800,000 CICLOS

Mecanismo de 3 Pasadores Instalación en Perfiles: 46901, 412540, 412544, 412545 y 79205

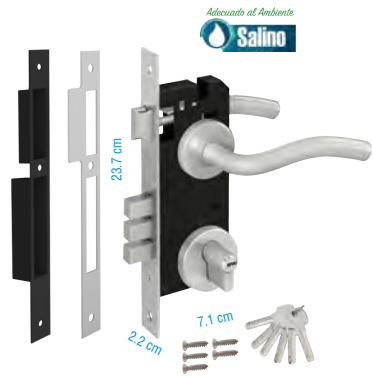

2865P
Llave - Llave
Cilindro 8 cm

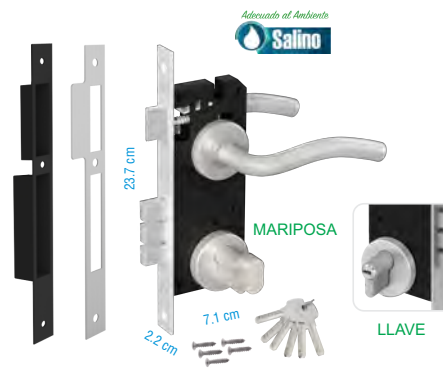

2865M
Llave - Mariposa
Cilindro 8 cm

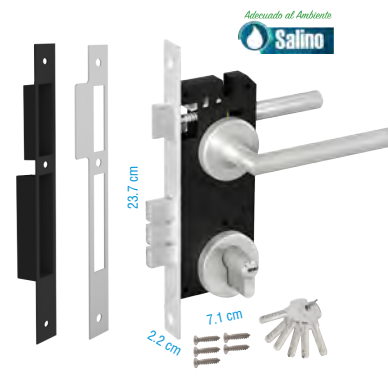

2822P
Llave - Llave
Cilindro 8 cm

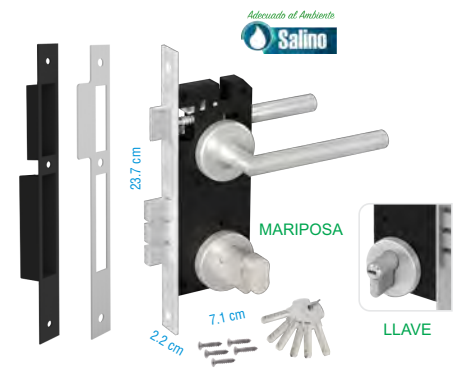

2822M
Llave - Mariposa
Cilindro 8 cm

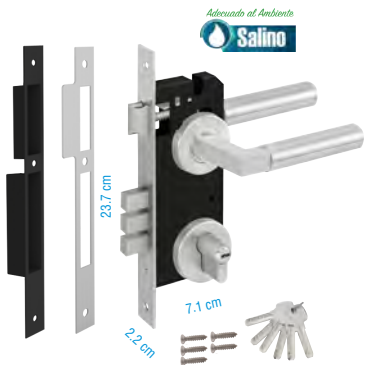

2910P
Llave - Llave
Cilindro 8 cm



2910M
Llave - Mariposa
Cilindro 8 cm



2867L
Llave - Llave
Cilindro 8 cm



2867P
Llave - Mariposa
Cilindro 8 cm

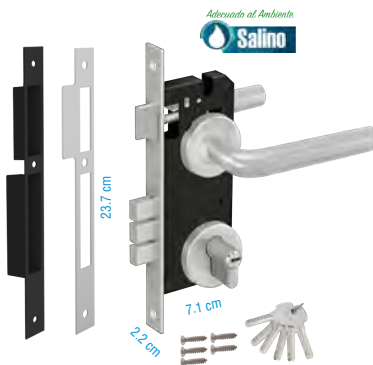

2868P
Llave - Llave
Cilindro 8 cm



2868M
Llave - Mariposa
Cilindro 8 cm

CHAPETONES OVALADOS

2401P
Llave - Llave
Cilindro 8 cm
1,850,000 CICLOS



ALTO RENDIMIENTO, RESISTENCIA AL AMBIENTE SALINO Y MAYOR SEGURIDAD 4,800,000 CICLOS

Mecanismo de 3 Pasadores Instalación en Perfiles: 46901, 412540, 412544, 412545 y 79205



CUERPO DE CHAPA

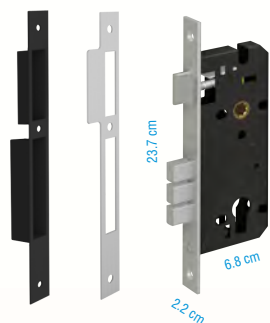

**ALTO RENDIMIENTO
ALTA SEGURIDAD**
Mecanismo de 3 Pasadores
4,800,000 CICLOS

- BP** Pieza
- BPC** 6 Piezas
- BPG** 12 Piezas

CILINDROS - 8 cm



Llave- Llave

- CLLP** Pieza
- CLLPC** 6 Piezas
- CLLPG** 12 Piezas



Llave- Mariposa

- CMP** Pieza
- CMPC** 6 Piezas
- CMPG** 12 Piezas

CILINDROS - 10 cm



Llave- Llave

- CL10** Pieza



Llave- Mariposa

- CM10** Pieza

MANIJAS ACERO INOXIDABLE



- H07** Pieza
- H07C** 6 Piezas
- H07G** 12 Piezas



- H10** Pieza
- H10C** 6 Piezas
- H10G** 12 Piezas

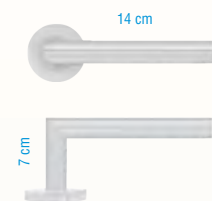

- H04** Pieza
- H04C** 6 Piezas
- H04G** 12 Piezas



- H06** Pieza
- H06C** 6 Piezas
- H06G** 12 Piezas

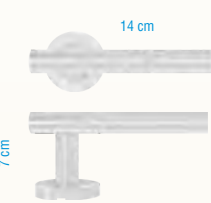

- H09** Pieza
- H09C** 6 Piezas
- H09G** 12 Piezas



- H13** Pieza
- H13C** 6 Piezas
- H13G** 12 Piezas



- H11** Pieza
- H11C** 6 Piezas
- H11G** 12 Piezas



- H28** Pieza
- H28C** 6 Piezas
- H28G** 12 Piezas

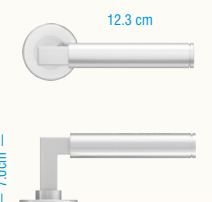

- H29** Pieza
- H29C** 6 Piezas
- H29G** 12 Piezas

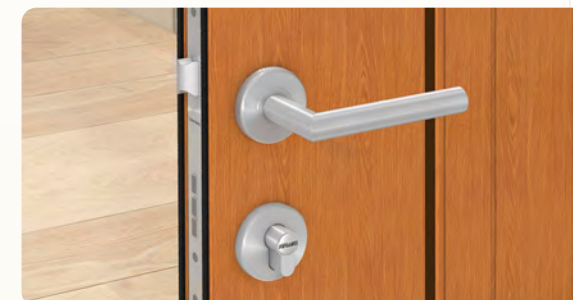

CERRADURAS

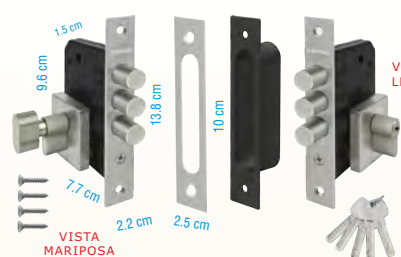

3 Bulones Niquel
Cilindro 8 cm
Llave - Mariposa

- 1993** Pieza
- 1993C** 4 Piezas
- 1993G** 8 Piezas

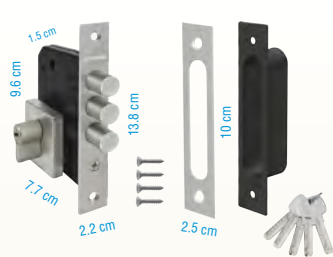

3 Bulones Niquel
Cilindro 8 cm
Llave - Llave

- 1994** Pieza
- 1994C** 4 Piezas
- 1994G** 8 Piezas

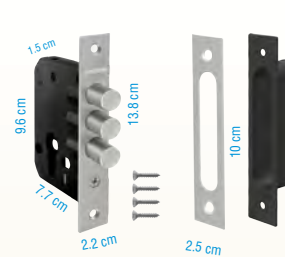

Pieza Reemplazo

Cuerpo para
Cerradura :

- 1993, 1994
- 1990** Pieza
- 1990C** 4 Piezas
- 1990G** 8 Piezas



Ambiente NO Salino

Chapas Recomendadas en Perfiles : 79205, 46901, 412540, 412544, 412545 y 12544

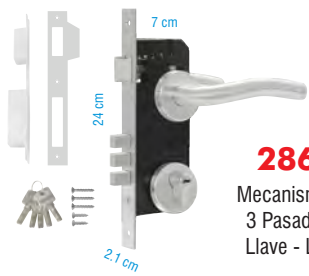

2865
Mecanismo de
3 Pasadores
Llave - Llave

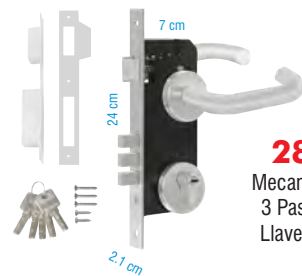

2866
Mecanismo de
3 Pasadores
Llave - Llave

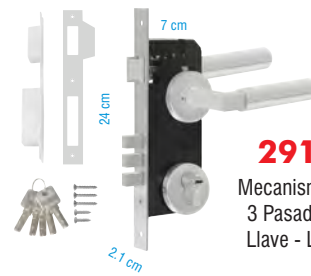

2910
Mecanismo de
3 Pasadores
Llave - Llave

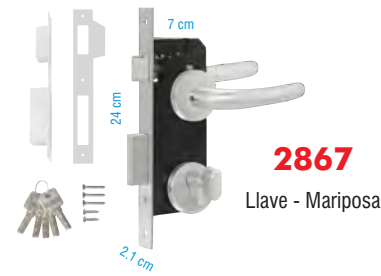

2867
Llave - Mariposa

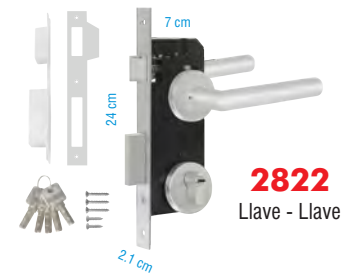

2822
Llave - Llave

CHAPA HUELLA DIGITAL

VISTA INTERIOR
7.2 cm
31 cm

VISTA EXTERIOR
7.2 cm

1002
Cerradura Perfiletto
Operación Derecha

500 Usuarios (Huellas)
100 Passwords

Apertura con:
Llave y Huella

3097
Cerradura
120 Usuarios
USO RUDO

Apertura con:
Llave, Huella y Sensor

Operación Izquierda / Derecha

Retire la Tapa
para Usar con Llave

PUERTA DE MADERA

Llave - Mariposa

2727

Satín



2658
Gatillo - Perilla
Llave - Llave

Satín Latón Latón Antiquo

RESIDENCIALES

3140
Cerradura Puerta
Alta Seguridad

Gatillo - Perilla
Llave - Llave

Satín

CONTRA ELÉCTRICA

Se recomienda Colocar con las
Chapas 458 y 1866

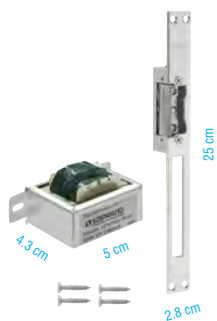

2323
Transformador Integrado
12 Volts

TRANSFORMADOR



1184
Transformador
de 110 A 240 VAC
12V para Selenoide

PALETA

3103 Pieza
3103C 20 Piezas
3103G 50 Piezas

Blanco Hueso Gris Negro

MARIPOSA

2917 Pieza
2917C 20 Piezas
2917G 40 Piezas

Satin

GANCHO

2036

Blanco Gris Negro

BAYONETA

839 Zamak
 Blanco Gris Negro

BAYONETA CON PERILLA

2256

Blanco Hueso Café
 Negro Gris

RESBALÓN METÁLICO

348 Fricción
 Cromo

RESBALÓN ALUMINIO NUEVO

1783 Pieza
1783C 50 Piezas
1783G 100 Piezas

Negro



IMANES DE NEODIMIO

INSTALACIÓN EN: **PUERTA MULTIDISEÑOS - PUERTA SAN LUIS Y PUERTA TOSCANA**



IB
 Juego de Imanes de Neodimio

22757

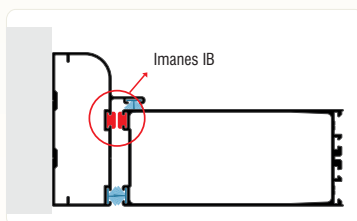

12531
 Canal Bisagra

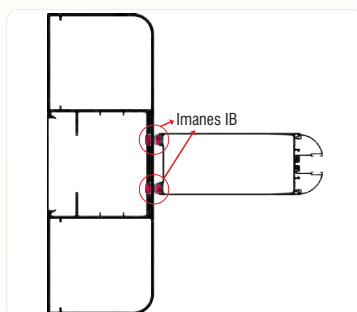

Vista Superior



Instalación en Batiente Instalación en Cerco



Vista Interior

INSTALACIÓN EN PUERTAS CON: **9256 Y 9236**

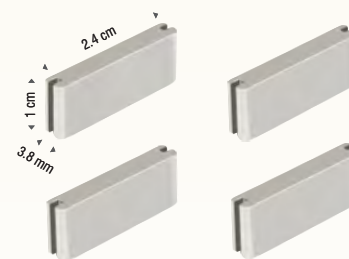

IC
 Juego de Imanes de Neodimio

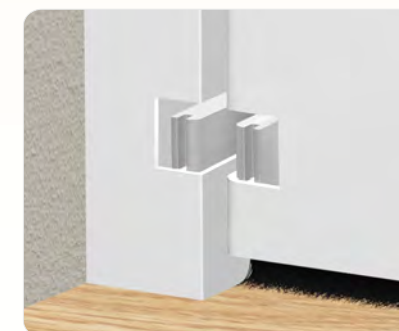
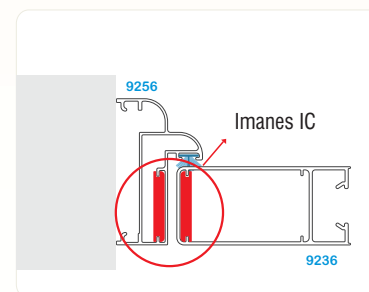
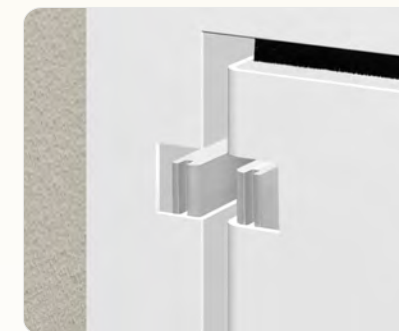

BISAGRA HIDRÁULICA PERFILETTO ALTO RENDIMIENTO

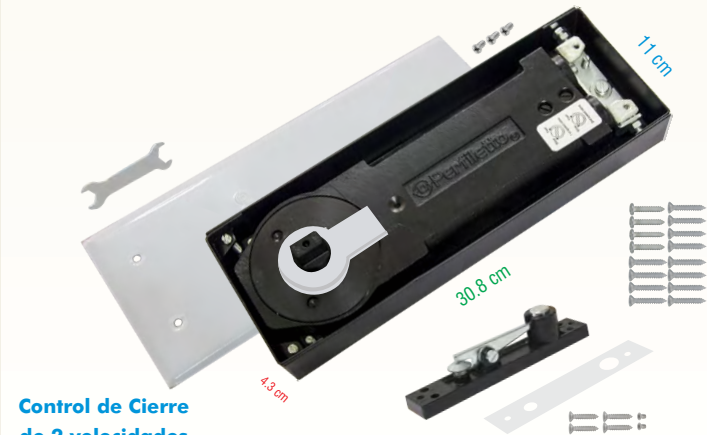

Control de Cierre de 2 velocidades
Capacidad 150 Kg.

1,250,000 Ciclos con 55 Kg
1,000,000 Ciclos con 70 Kg

Fácil Instalación Uso Rudo

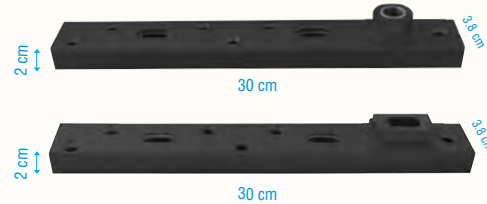

Brazos No aptos en Cabezales: 9207, 69207

- 1999P** Juego
- 1999PC** 4 Juegos
- 1999PG** 8 Juegos



PIEZAS REEMPLAZO

Bisagra Hidráulica



- 2000P** Pieza
- 2000PC** 4 Piezas
- 2000PG** 8 Piezas

Brazos y Pivote Superior

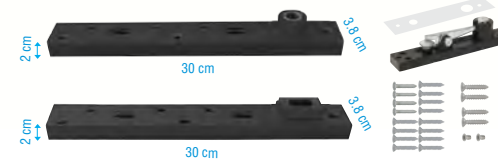

- BB** Juego
- BBC** 4 Juegos
- BBG** 8 Juegos



356

Mod. S202N (Capacidad 130 Kg.)

700,000 Ciclos



- 466** Juegos
- 466C** 4 Juegos
- 466G** 8 Juegos

Dortek mod. BH200D (Capacidad 130 Kg.)

850,000 Ciclos



781

Dawh Mod. 500 (Capacidad 110 Kg.)

650,000 Ciclos

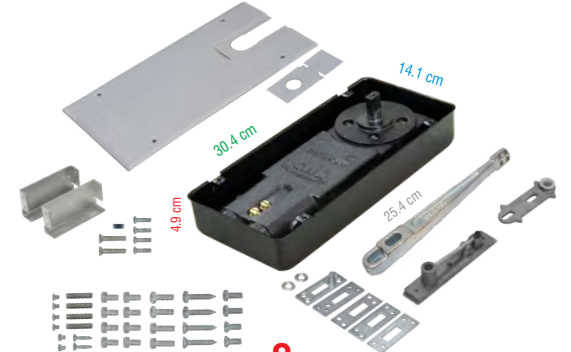

9

Jackson Mod CRL 330 (Capacidad 120 Kg.)

1,350,000 Ciclos

BISAGRA HIDRÁULICA AÉREA

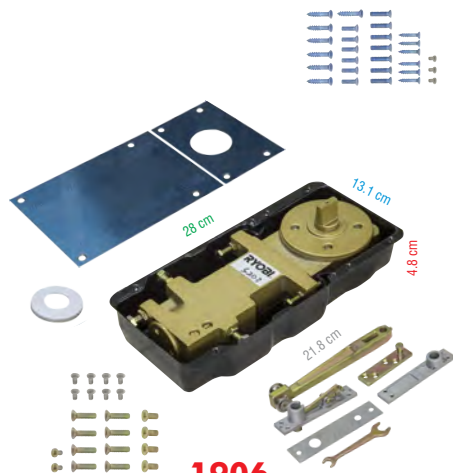

1906

Mod. S203N (Capacidad 180 Kg.)

1,050,000 Ciclos



2593

(Capacidad 110 kg.)

Cuerpo : Largo= 29.4 cm,
Ancho= 9.5 cm, Altura= 3.8 cm.

1,437,000 Ciclos

Área Mínima para su Instalación:

4" x 1 3/4"

Colocación Parte Superior



BISAGRA DE PISO DOBLE ACCIÓN

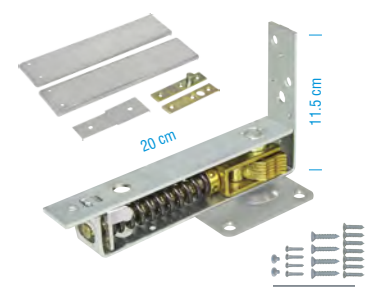

450

Phillips (Capacidad: 35 Kg.)

- Latón
- Latón Antiguo

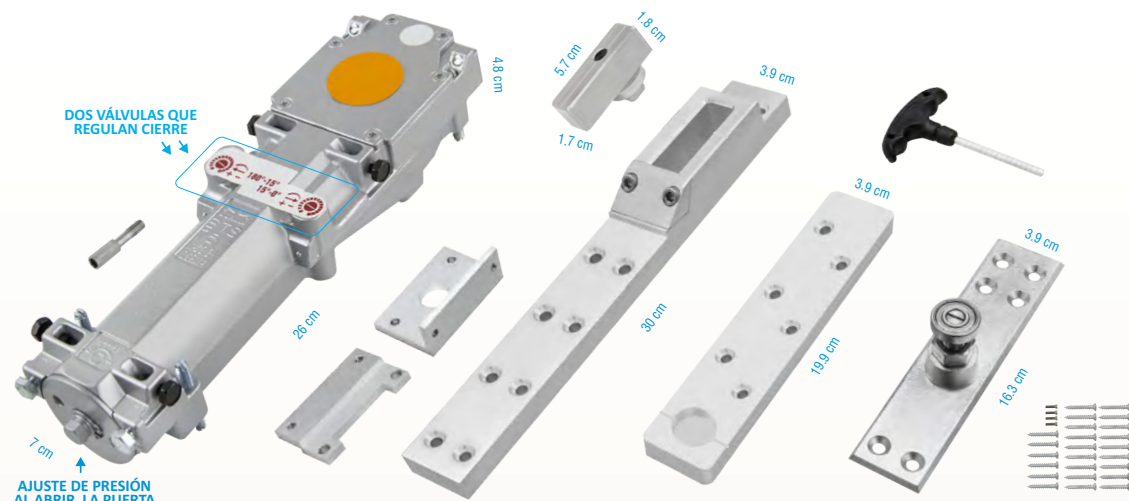

3,000,000 de Ciclos con 35 Kg

BA Juego

Instalación en Perfiles:

9117, 12531, 14386

Incluye:

- Bisagra Hidráulica Aérea
- Brazo Superior
- Brazo Inferior con Punto de Giro
- Capacidad: 120 Kg

Área Mínima para su Instalación:

3" x 1 7/8"

LÍNEA 3"

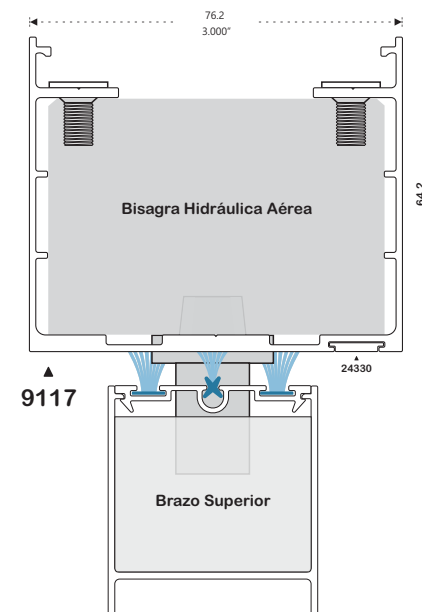

CIERRA PUERTAS



Durabilidad en Ciclos:

Comercial

Capacidad: 70 Kg.

- 2139** Pieza
- 2139C** 5 Piezas
- 2139G** 10 Piezas

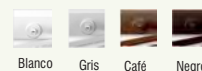

5,000,000 Ciclos con 35 kg



Durabilidad en Ciclos:

Residencial

Capacidad: 50 Kg.

- 2143** Pieza
- 2143C** 5 Piezas
- 2143G** 10 Piezas

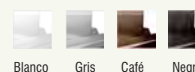

2,500,000 Ciclos con 35 kg

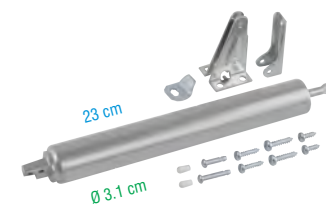

255

Capacidad: 15 kg



PIVOTES DESCENTRADOS

Durabilidad en ciclos:

Alto Rendimiento 680,000 Ciclos

93P Juego
93PC 10 Juegos
93PG 20 Juegos

Blanco Gris Negro Hueso

Fácil Instalación

93

Blanco Hueso Natural Negro

Durabilidad en Ciclos: 415,000 Ciclos

PIVOTES CENTRADOS

Adecuado al Ambiente

Salino **217**
Zamak

Durabilidad en Ciclos: 293,680 Ciclos

PASADORES DE MAROMA

Perfiletto
ALUMINUM

Adecuado al Ambiente

Salino

ACERO INOXIDABLE USO RUDO

PROFUNDIDAD

2.3 cm

28 cm

17 cm

4.4 cm

4 cm

5.7 cm

2.2 cm

2.47 cm

Ø 2.48 cm

9 cm

4 cm

Ø 1.2 cm

Ø 1.9 cm

2220 Pieza
2220C 10 Piezas
2220G 20 Piezas

PIEZA REEMPLAZO

1006 Pieza
1006CC 10 Piezas
1006CG 20 Piezas

Ø 2.48 cm
4 cm
Ø 1.8 cm

NUEVO

1.9 cm

24 cm

2.2 cm

2221 Pieza
2221C 10 Piezas
2221G 20 Piezas

Blanco Gris Negro

81
Aluminio

15 cm

2.4 cm

37.5 cm

4.1 cm

Blanco Hueso Natural Electro Negro

1016
Zamak

14.3 cm

2.4 cm

25.6 cm

3.8 cm

Blanco Hueso Gris Negro

1880
Zamak

14.4 cm

2.4 cm

28.5 cm

3.6 cm

Blanco Gris Negro

2258
Zamak

14.4 cm

2.3 cm

25.5 cm

3.6 cm

Blanco Gris Café

BARRAS ANTIPÁNICO

Barra Antipánico de Acción Horizontal



838P Pieza
838PC 4 Piezas
838PG 8 Piezas



Gris



Contra Diseñada para Contramarcos 3"

Perfiles: 9116, 9132, 9133 y 9134



CBA Pieza
 Gris

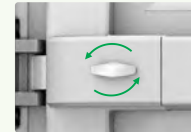

Mariposa para Retención del Pestillo

Acción Horizontal

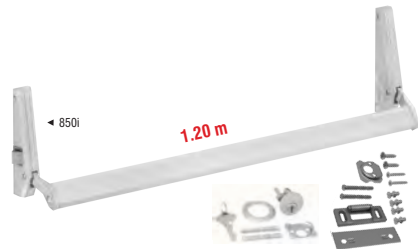

850D Derecha
850i Izquierda



Blanco Gris Café

Acción Vertical



1021 Acero Inox.



1020 Blanco Gris Café

BARRAS DE EMPUJE



NUEVO

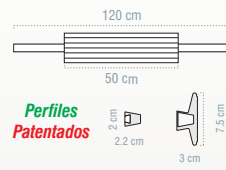
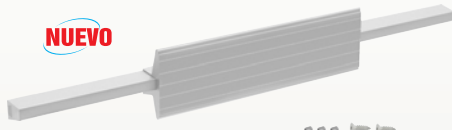

Perfiles Patentados

888P Pieza
888PC 4 Piezas
888PG 8 Piezas



Natural Blanco Negro Hueso



La Barra Oculta Pijas de Fijación



Fijación Rápida con Opresor

PLACA

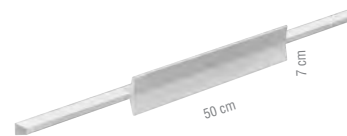

Lisa

220 1.00 m
216 1.20 m



Blanco Hueso Natural Negro

BASTÓN

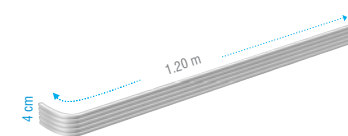

1168 1.20 m



Blanco Hueso Natural Negro

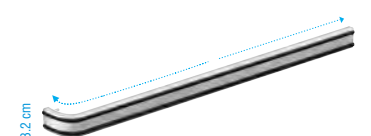

430 1.00 m
431 1.20 m



Blanco Hueso Natural Electro Negro

VENTANAS BATIENTES LINEA 2" Y SERIE 35

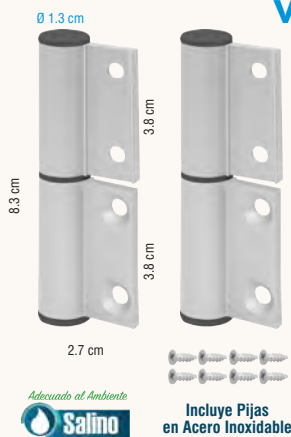

BS35 Par
BS35C 15 Pares
BS35G 30 Pares



DESA

DESARMADA PARA PINTAR O SUBLIMAR
EN NUESTROS ACABADOS
Prueba Realizada con 14 Kg
Durabilidad en Ciclos:
1,100,000 Ciclos

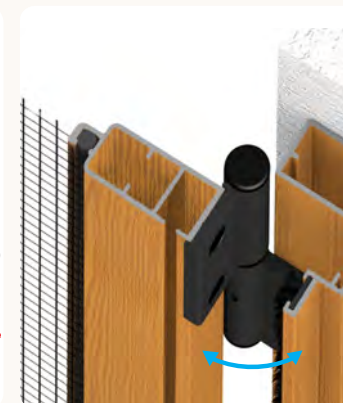
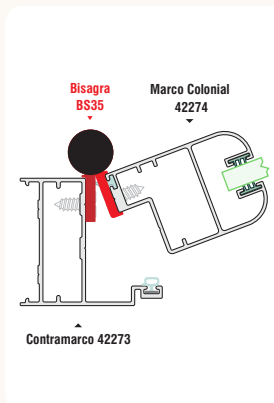

PIEZAS REEMPLAZO



KBS35 Juego
KBS35C 15 Juegos
KBS35G 30 Juegos



Capacidad hasta 15 Kg por Par



VENTANAS BATIENTES LÍNEA 3" Y SERIES 50, 70, 80 Y 100

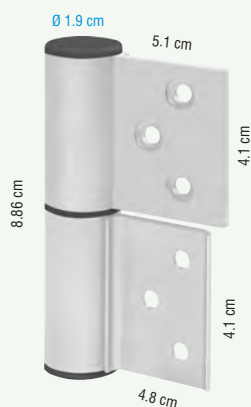

Remaches al Color de la Bisagra
Remache #54

1909 Pieza
1909C 20 Piezas
1909G 40 Piezas

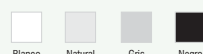

DESA

DESARMADA PARA PINTAR O SUBLIMAR
EN NUESTROS ACABADOS
Prueba Realizada con 14 Kg
Durabilidad en Ciclos:
4,500,000 Ciclos

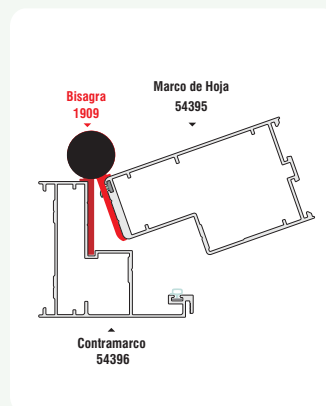

PIEZAS REEMPLAZO



K1909 Juego
K1909C 20 Juegos
K1909G 40 Juegos



Capacidad hasta 20 Kg por Par



Barras de Aluminio
Acabado Natural Mate

PUERTA BATIENTE U-LIGHT / C-LIGHT Y 2"

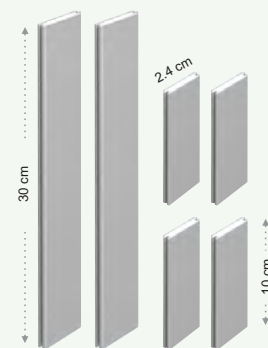
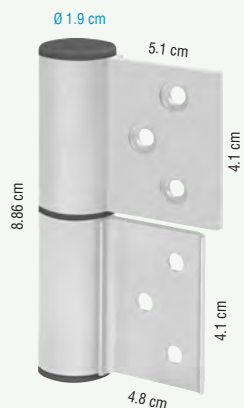

1909P Juego
1909PC 9 Juegos
1909PG 18 Juegos



Remaches al Color de la Bisagra
Remache #54

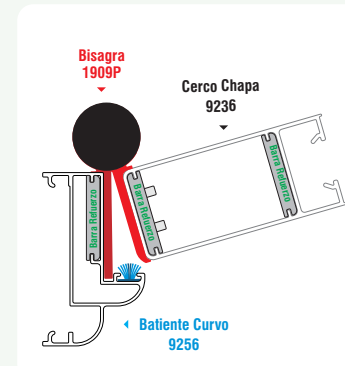

Capacidad hasta 25 Kg por Par

DESARMADA PARA PINTAR O SUBLIMAR
EN NUESTROS ACABADOS



CABEZAL

Armado de Cerco,
Lado del Cierre



ZOCLO

Lado del Cierre



DETALLE DE BISAGRA

Instalación de Bisagras Superior e Inferior
Armado de Cerco, Lado donde se Instalan las Bisagras

BISAGRA PUERTA MULTIDISEÑOS Y PUERTA SAN LUIS

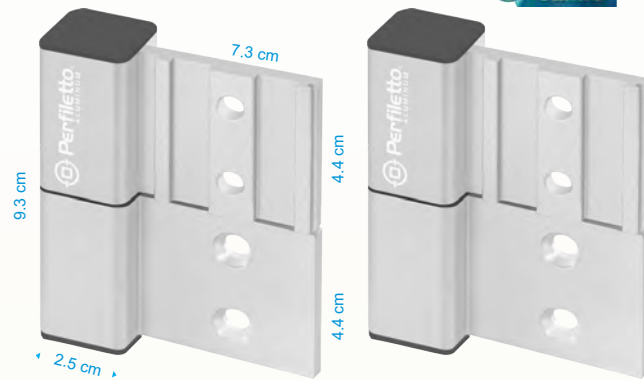

Pijas en Acero Inoxidable



Prueba Realizada con 35 Kg
Durabilidad en Ciclos:
4,000,000 Ciclos

- 1523P** Par
- 1523PC** 8 Pares
- 1523PG** 16 Pares



REFUERZO EN BISAGRA



ACABADOS:

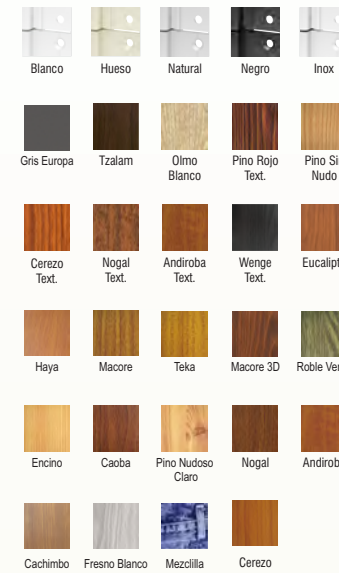

PIEZAS REEMPLAZO

Tapa



- T1523** Pieza
- T1523C** 16 Piezas
- T1523G** 32 Piezas

Rondana



- E1523** Pieza
- E1523C** 16 Piezas
- E1523G** 32 Piezas

Opresor



- OBP** Pieza



DESARMADA PARA PINTAR O SUBLIMAR EN NUESTROS ACABADOS

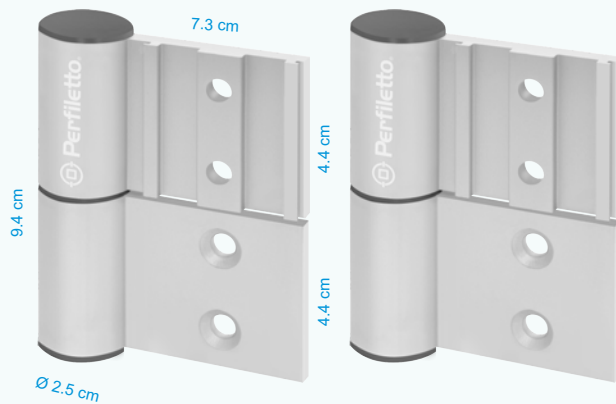

Pijas en Acero Inoxidable



Soporta 40 Kg por Par
Prueba Realizada con 35 Kg
Durabilidad en Ciclos:
4,000,000 Ciclos

- 1525P** Par
- 1525PC** 8 Pares
- 1525PG** 16 Pares



REFUERZO EN BISAGRA



Acabados:

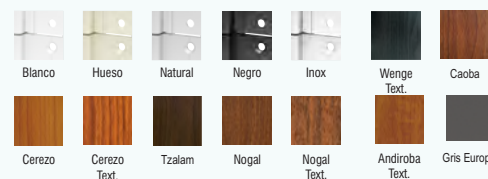

Rondana



PIEZAS REEMPLAZO

- E1523** Pieza
- E1523C** 16 Piezas
- E1523G** 32 Piezas



Opresor



- OBP** Pieza



DESARMADA PARA PINTAR O SUBLIMAR EN NUESTROS ACABADOS

BISAGRA TRIPLE REFORZADA

NUEVO

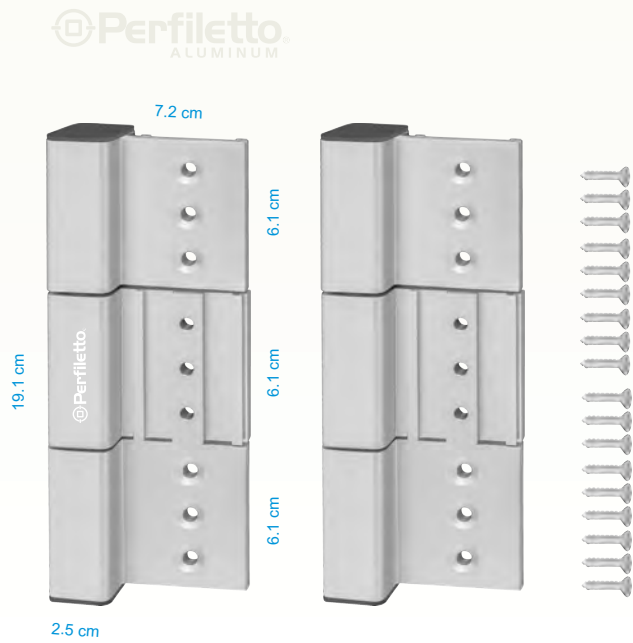

- 1522P** Par
- 1522PC** 5 Pares
- 1522PG** 10 Pares

Soporta 60 Kg por Par

- | | | |
|-------------------|-----------------------------|-------|
| | | |
| Natural | Blanco | Negro |
| | | |
| Nogal Texturizado | Cerezo | Caoba |
| | | |
| Cachimbo | Nogal Americano Texturizado | DESA |

DESARMADA PARA PINTAR O SUBLIMAR EN NUESTROS ACABADOS



BISAGRAS EXCLUSIVAS EN PERFILES MARCA PERFILETTO

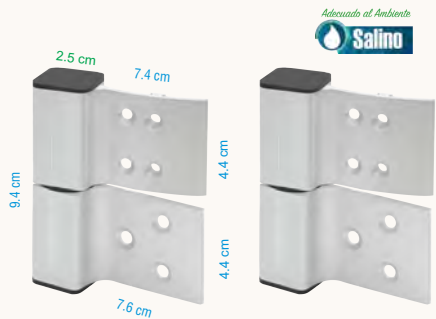

Adaptado al Ambiente **Salino**

- 1524L** Par
- 1524LC** 8 Pares
- 1524LG** 16 Pares

- | | | |
|---------|--------|-------|
| | | |
| Natural | Blanco | Negro |
- Soporta 30 Kg por Par**



PERFILES:



Tornillos: al Color de la Bisagra



DESARMADA PARA PINTAR O SUBLIMAR EN NUESTROS ACABADOS

DESA

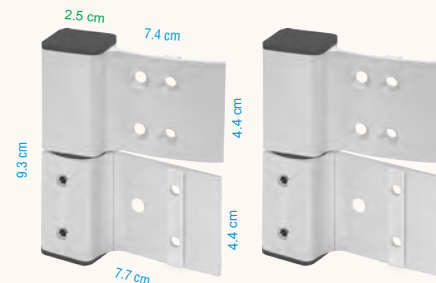

- 1524F** Par
- 1524FC** 8 Pares
- 1524FG** 16 Pares

- | | | |
|---------|--------|-------|
| | | |
| Natural | Blanco | Negro |
- Soporta 30 Kg por Par**



PERFILES:



Tornillos: al Color de la Bisagra



DESARMADA PARA PINTAR O SUBLIMAR EN NUESTROS ACABADOS

DESA

BISAGRA PUERTA MONUMENTAL



Perfiletto
ALUMINUM

- BM** Par
- BMC** 6 Pares
- BMG** 12 Pares



Inox



Capacidad 50 Kg por Par

DESARMADA PARA PINTAR O SUBLIMAR EN NUESTROS ACABADOS

DESA

Pintable en Nuestros Acabados

BISAGRA PUERTA FERRARA

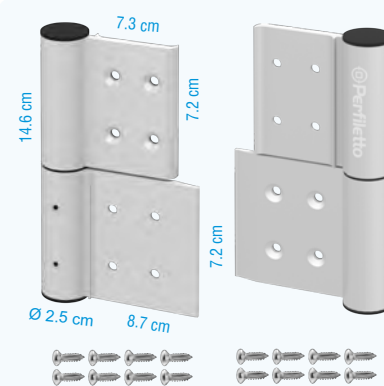

Perfiletto
ALUMINUM

- BF** Par
- BFC** 8 Pares
- BFG** 16 Pares

- | | | |
|--------|-------|----------|
| | | |
| Blanco | Negro | Anod. NM |



DESARMADA PARA PINTAR O SUBLIMAR EN NUESTROS ACABADOS

DESA

Pintable en Nuestros Acabados

LÍNEAS: BAÑO y MAMPARAS

Instalación en Perfiles: 4127, 7102, 9069, 68802, 8802, 611035, 11035, 9756 y 6854

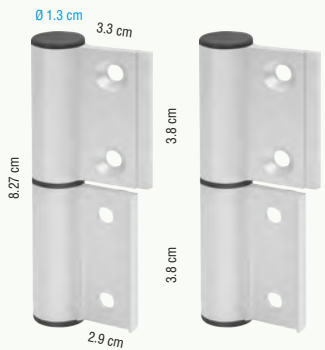

1910 Par
1910C 10 Pares
1910G 20 Pares



Pintable en Nuestros Acabados

Soporta 15 Kg por Par



Pijas: al Color de la Bisagra

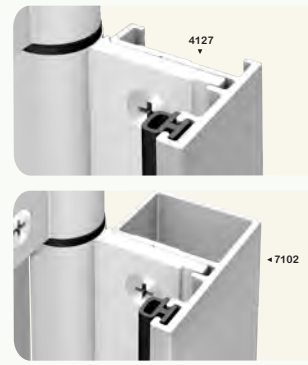
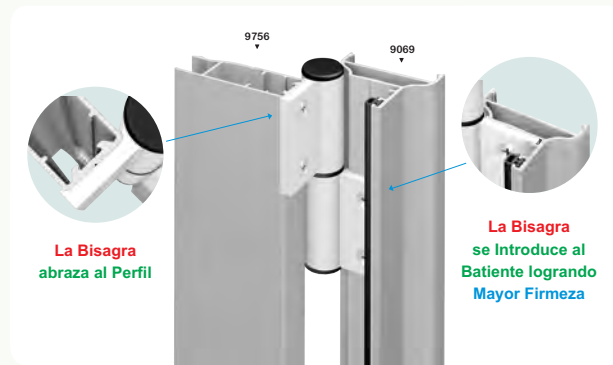

BANDERA

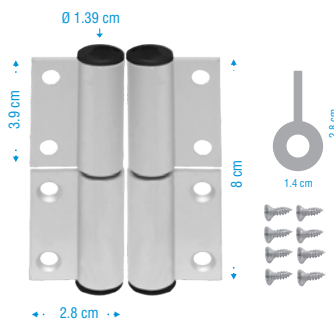

BEVN
Izquierda-Derecha Par



LÍNEA 1400

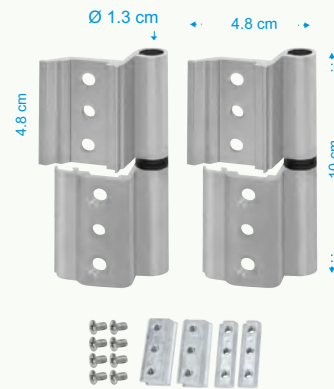

DOS PALAS

BD14
Par

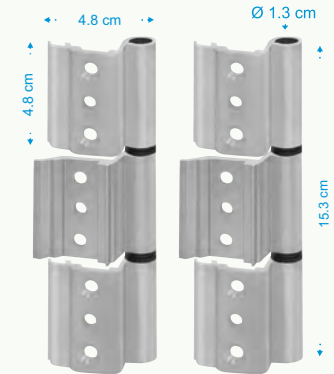
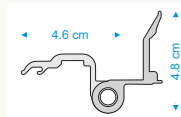

TRES PALAS

BT14
Par

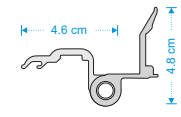

LIBRO

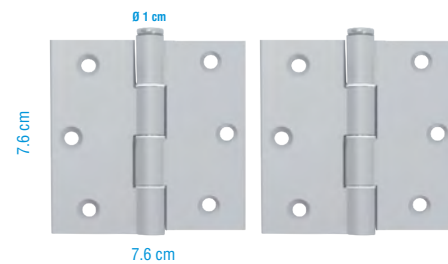

6 Par
6C 20 Pares
6G 40 Pares

Aluminio 3" x 3" - Par

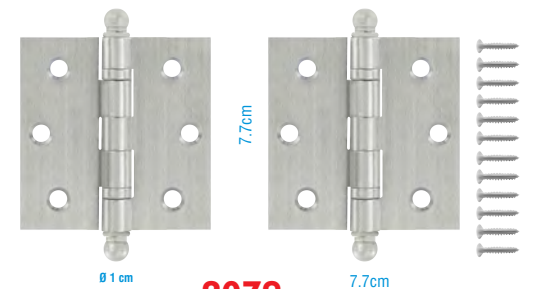

2079
Acero Inoxidable 3" x 3" - Par

PIANO

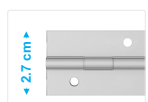

2
Aluminio
2.7 cm x 1.85 m

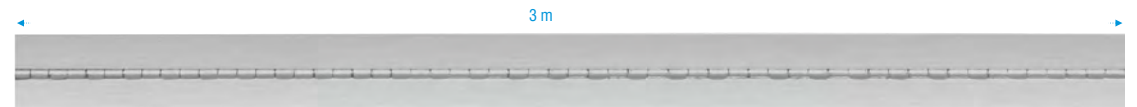

2604
Acero Inoxidable
5 cm x 3 m



Barras de Armado Rápido con Opresores de Punta en Acero Inoxidable



Clave:	Cortado del Perfil: 22538	Longitud
BO33	Perfil: 9187,9207	34.2 mm
BOi33	Perfil: 9183	34.2 mm
BO57	Perfil: 19187	56.9 mm
BOi92	Perfil: 412602	91.7 mm
BO107	Perfil: 412596	107.3 mm
BO207	Perfil: 412599	207.1 mm

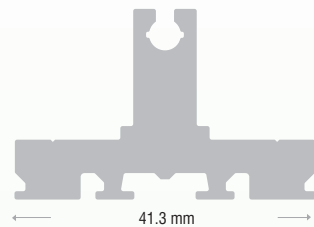

Clave:	Cortado del Perfil: 22538	Longitud
BA33	Perfil: 9207, 9183, 9187	34.2 mm
BA57	Perfil: 19187	56.9 mm
BA92	Perfil: 412602	91.7 mm
BA107	Perfil: 412596	107.3 mm
BA1M		1 m

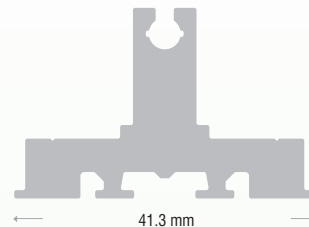

Clave:	Cortado del Perfil: 22537	Longitud
BA183	Perfil: 412597	182.6 mm
BA207	Perfil: 412599	207.1 mm
BR1M	NUEVO	1 m

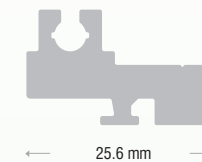

Clave:	Cortado del Perfil: 12538	Longitud
MB33	Perfil: 9187	34.35 mm
MB57	Perfil: 19187	56.90 mm
MB107	Perfil: 412596	107.3 mm

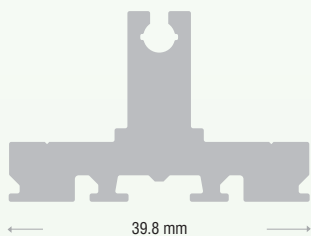

Clave:	Cortado del Perfil: 22538	Longitud
BAi33	Intermedio: 9183	34.2 mm
BAi92	Intermedio: 412602	91.7 mm
BU1M	NUEVO	1 m

PUERTA SAN LUIS

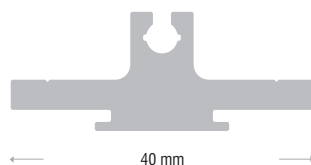

Clave:	Cortado del Perfil: 12537	Longitud
BSL32	Perfil: 79187 y 79183	32.35 mm
BSL57	Perfil: 89187	56.90 mm
BSL108	Perfil: 712596	107.9 mm



PUERTA FERRARA

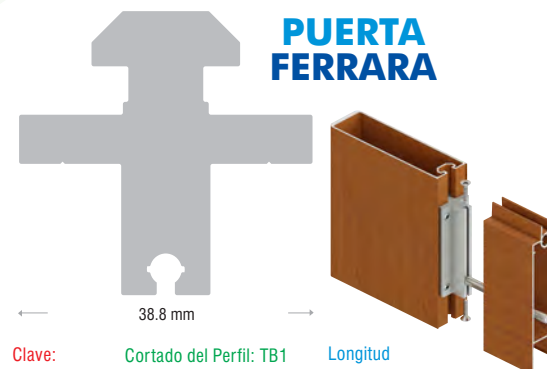

Clave:	Cortado del Perfil: TB1	Longitud
TBC	Perfil: TC1	108.6 mm
TBZ	Perfil: TZ1	101.5 mm

PIJAS

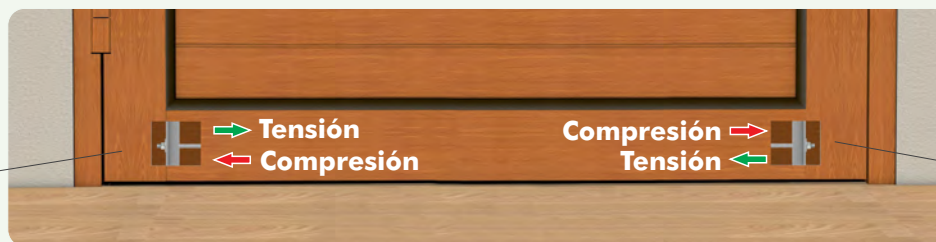

La Barra de Armado trabaja a la Tensión y Compresión

Se recomienda Armar con Tensor en Medidas Mayores a 1 m

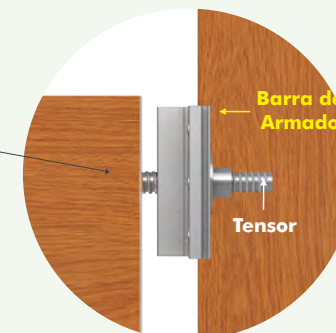

TENSORES 3/8 "

Incluyen: 2 tuercas y 2 rondanas



1 m	137	Pieza
	137C	10 piezas
	137G	25 piezas

1.20 m	138	Pieza
	138C	10 piezas
	138G	25 piezas

3 m	1044	Pieza
	1044C	10 piezas
	1044G	20 piezas

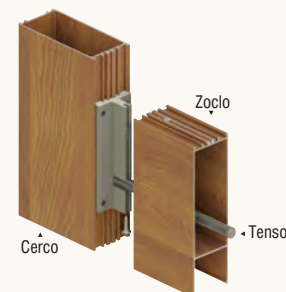

PIEZAS REEMPLAZO



MATRACAS



Incluye Felpa y Tapas



GUARDAPOLVO



GP1 1.00 m
GP1.2 1.20 m
 Pintable en Nuestros Acabados

TAPAS GUARDAPOLVOS



Blanco Negro
 Gris Café

TGP Par
TGPC 40 Pares
TGPG 80 Pares
 Instalación en Perfiles 5566 y 29188



Derecha Izquierda



TAPA ZOCLO
 Perfiles 8324 y 8325

TZM Par
 Acabados:
 Negro Gris

GUARDAPOLVOS

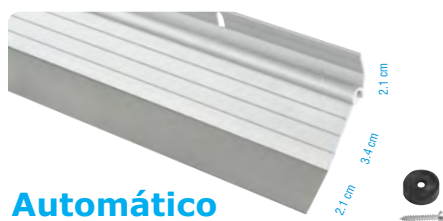

Automático

127 1.00 m
 Natural Blanco G2 Negro

183 1.20 m
 Hueso G2 Negro



Sencillo

128 1.00 m
 Blanco Natural Hueso Negro

TOPES



2901
 Acero Inox.



134 Codo
 Blanco Gris Negro



864
 Esférico



2902
 Acero Inox.

TOPE MÁGNETICO

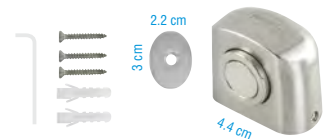

2724 Metálico
 Satín Cromo Latón Latón Antiguo

POSICIONADOR



1280
 Pata de cabra

Blanco Gris Negro



NUEVO

3010
 Vertical

Cromo



3009
 Vertical

Blanco Gris Negro

CADENA METÁLICA



15R

Cadena 4.5 mm
 Rollo de 50 m



15

Cadena 4.5 mm
 Metro



40

Candado

CIERRE FINAL

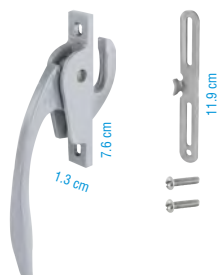

2074

Blanco Hueso Gris Negro

TELESCÓPICO
 Aperturas a 27 cm y 44 cm



2292

Gris Negro





1.2 cm



7.5 cm

8.4 cm

CARRUCHA PARA OPERADOR

Operadores: **805PD, 805Pi**

- CPO** Pieza
- CPOC** 10 Piezas
- CPOG** 20 Piezas

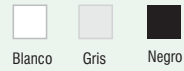

Carrucha CPO



Cadena CADM



- CADM** Metro
- CADR** Rollo 200 m
- CAD4R** 4 Rollos 800 m

CADENA PLÁSTICA

SOPORTA **10 Kg**
A LA TENSION



UC
Unión Cadena

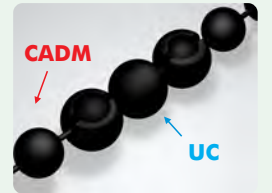

ALTO RENDIMIENTO

Fijación por el Interior Logrando Vista Elegante

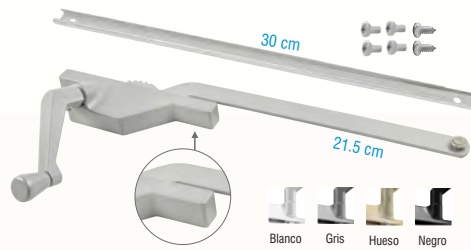

IZQUIERDO

- 805Pi** Pieza
- 805PiC** 10 Piezas
- 805PiG** 20 Piezas



DERECHO

- 805PD** Pieza
- 805PDC** 10 Piezas
- 805PDG** 20 Piezas

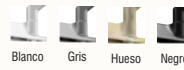

COMERCIAL



IZQUIERDO

- 26i** Pieza
- 26iC** 10 Piezas
- 26iG** 20 Piezas

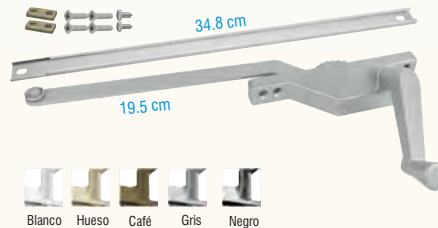

DERECHO

- 26D** Pieza
- 26DC** 10 Piezas
- 26DG** 20 Piezas



CORTOS



IZQUIERDO

- 2804** Pieza
- 2804C** 10 Piezas
- 2804G** 20 Piezas

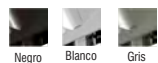

DERECHO

- 2803** Pieza
- 2803C** 10 Piezas
- 2803G** 20 Piezas

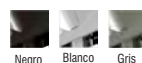

PIEZA REEMPLAZO MARIPOSA

2646
Operador Brazo Corto ó Largo

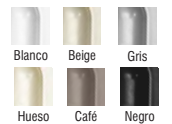

CELOSÍA G-28 Manivela



78



ALTO RENDIMIENTO

Fijación por el Interior Logrando Vista Elegante

BRAZO LARGO

IZQUIERDO



Manivela

805Vi Pieza
805ViC 10 Piezas
805ViG 20 Piezas

DERECHO



Manivela

805VD Pieza
805VDC 10 Piezas
805VDG 20 Piezas

IZQUIERDO



Mariposa

805Mi Pieza
805MiC 10 Piezas
805MiG 20 Piezas

DERECHO



Mariposa

805MD Pieza
805MDC 10 Piezas
805MDG 20 Piezas



IZQUIERDO

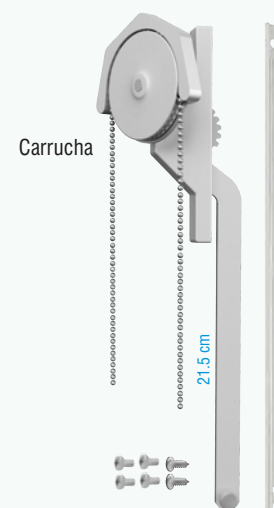

Carrucha

805Ci Pieza
805Ci 10 Piezas
805Ci 20 Piezas

DERECHO

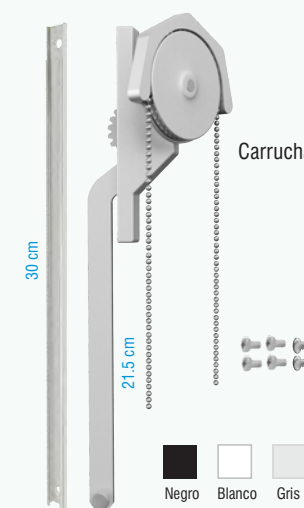

Carrucha

805CD Pieza
805CD 10 Piezas
805CD 20 Piezas

BRAZO CORTO

IZQUIERDO



Manivela

2804V Pieza
2804VC 10 Piezas
2804VG 20 Piezas

DERECHO



Manivela

2803V Pieza
2803VC 10 Piezas
2803VG 20 Piezas

IZQUIERDO



Carrucha

2804C Pieza
2804CC 10 Piezas
2804CG 20 Piezas

DERECHO



Carrucha

2803C Pieza
2803CC 10 Piezas
2803CG 20 Piezas



IZQUIERDO

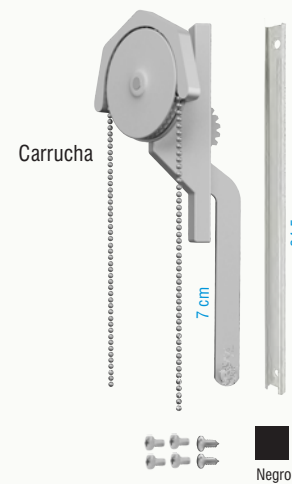

Carrucha

2804M
2804MC
2804MG

DERECHO

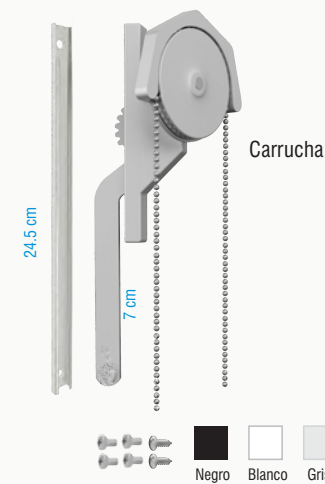

Carrucha

2803M
2803MC
2803MG

LÍNEA 2" BATIENTE O PROYECCIÓN

CON EMPAQUES DISEÑADOS PARA ESTA SERIE

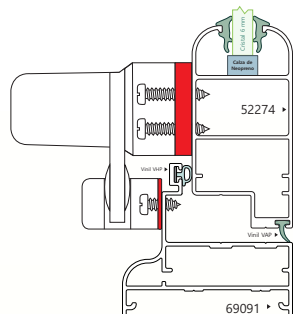

- M2** Pieza Blanco
- M2C** 10 Piezas Gris
- M2G** 20 Piezas Negro

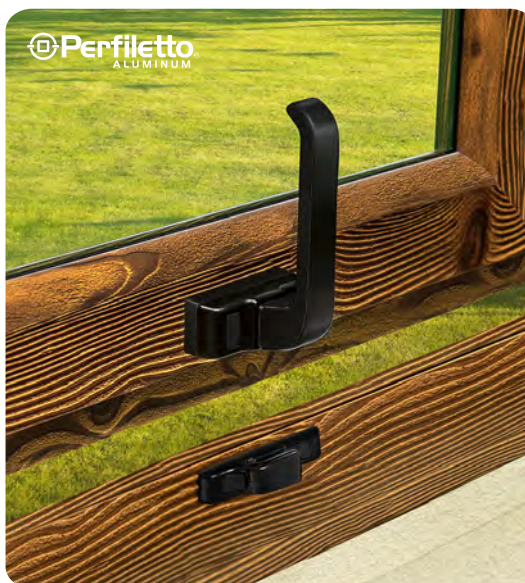

LÍNEA 3", SERIE 50, 70, 80 y 100

BATIENTE "O" PROYECCIÓN

CON EMPAQUES DISEÑADOS PARA ESTA SERIE

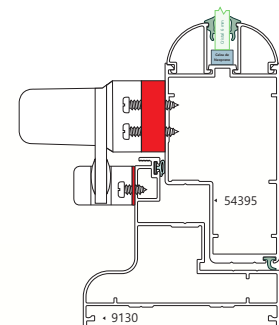

- M3** Pieza Blanco
- M3C** 10 Piezas Gris
- M3G** 20 Piezas Negro

LÍNEA 2" VENTANA PROYECCIÓN

CON EMPAQUES DISEÑADOS PARA ESTA SERIE

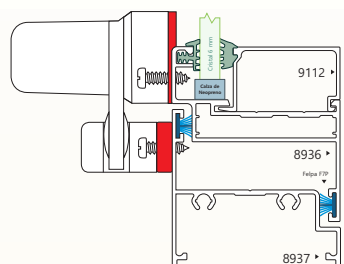

- MT2** Pieza Blanco
- MT2C** 10 Piezas Gris
- MT2G** 20 Piezas Negro

MANIJA y EMPAQUES DE AJUSTE DISEÑADAS PARA CADA LÍNEA

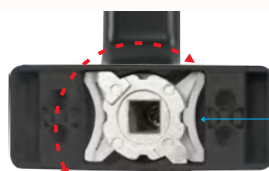

Sistema que mantiene su posición al estar abierta

LÍNEA SERIE 35 RECTA

CON EMPAQUES DISEÑADOS PARA ESTA SERIE

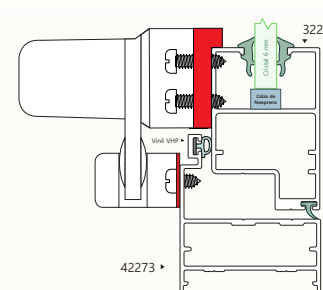

- MR35** Pieza Blanco
- MR35C** 10 Piezas Gris
- MR35G** 20 Piezas Negro

LÍNEA SERIE 35 COLONIAL

CON EMPAQUES DISEÑADOS PARA ESTA SERIE

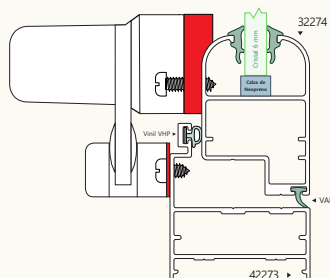

- M35** Pieza Blanco
- M35C** 10 Piezas Gris
- M35G** 20 Piezas Negro



LÍNEA 1400

CON EMPAQUES DISEÑADOS PARA ESTA SERIE

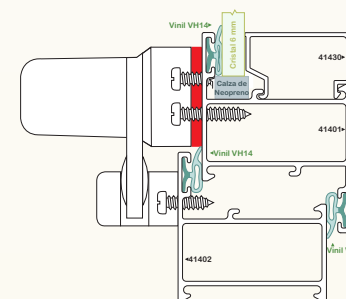

- NUEVO**
- M14** Pieza Blanco
 - M14C** 10 Piezas Gris
 - M14G** 20 Piezas Negro

Manija Ventana de Proyección



Blanco Negro

NUEVO

- MP** Pieza
- MPC** 10 Piezas
- MPG** 20 Piezas



Negro



- 3008** Pieza
- 3008C** 10 Piezas
- 3008G** 20 Piezas



Blanco Gris Negro



- 1578C** Pieza
- 1578CC** 10 Piezas
- 1578CG** 20 Piezas



Blanco Negro



- 1578R** Pieza
- 1578RC** 10 Piezas
- 1578RG** 20 Piezas



Con llave

Blanco Negro



- 3067** Pieza
- 3067C** 10 Piezas
- 3067G** 20 Piezas

Probados en Nuestro Centro de Investigación y Desarrollo



PESO MÁXIMO RECOMENDADO
20 KG PAR



DURABILIDAD 900,000 CICLOS

PRUEBAS REALIZADAS :

- 15 mm DE HOLGURA ENTRE MARCO Y CONTRAMARCO
- APERTURA DE 50 cm
- VENTANA EN MEDIDA DE 1.00 m X 1.20 m
- BRAZOS DE 24"

..... 6"
BP6 Par
BP6C 5 Pares
BP6G 10 Pares

..... 12"
BP12 Par
BP12C 5 Pares
BP12G 10 Pares

..... 20"
BP20 Par
BP20C 5 Pares
BP20G 10 Pares

..... 8"
BP8 Par
BP8C 5 Pares
BP8G 10 Pares

..... 16"
BP16 Par
BP16C 5 Pares
BP16G 10 Pares

..... 24"
BP24 Par
BP24C 5 Pares
BP24G 10 Pares

BRAZOS FRICCIÓN



1911 Pieza
1911C 10 Piezas
1911G 20 Piezas



1912 Pieza
1912C 10 Piezas
1912G 20 Piezas



1916 Pieza
1916C 10 Piezas
1916G 20 Piezas

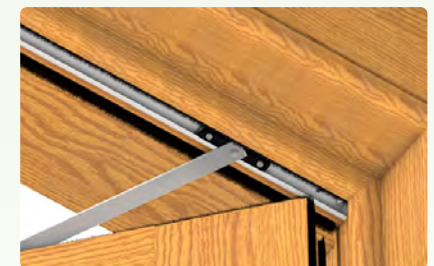

PRUEBA REALIZADA CON 14 Kg 2,100,000 Ciclos

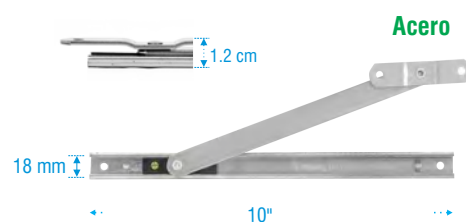

1946
10" Pieza

INTERIOR

Brazo Fricción

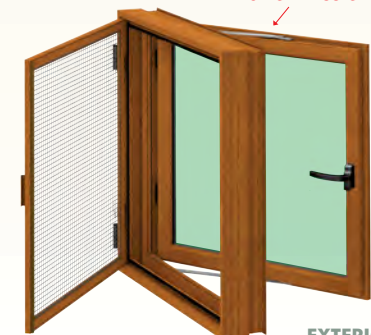

EXTERIOR

Instalación al Interior

Incluye:
Control Remoto y Botonera

SAA Pieza
SAAC 2 Sistemas
SAAG 4 Sistemas

Potencia: 96 w
Alimentación: 110 - 220 v 60 hz
Apertura hasta: 30 cm
Fuerza al Abrir: 31 Kg
Velocidad: 12 mm / seg.
Fuerza al Abrir: 31 Kg

Recomendado para Ventanas Mayores de **50 cm de Ancho**

Ver Manual para Conectarlo con el Operador SAA

Ø 10.5 cm

DH
Detector de Humo
Con Alarma de 85 Decibeles

Alimentación 9 V con Batería o 12 V con Transformador (No Incluidos)

SACR
Control Remoto

Potencia: 30 - 36 w
Alimentación: 120 V
Apertura hasta: 30 cm
Fuerza al Abrir: 31 Kg
Velocidad: 9 mm / seg.

SA
Sin Control Remoto

Potencia de Salida: 150 w
Alimentación: 115 V 60 HZ
1a Apertura: 25 cm con 180 N
2a Apertura: 25-38 cm 90 N
Velocidad: 30 mm/seg.

BALANCINES Y COMPLEMENTOS VENTANA GUILLOTINA

Juego C Light y 2"

170-2 12"
171-2 14"
172-2 17"
173-2 20"
174-2 24"
175-2 28"
176-2 30"

Juego 3"

170-3 12"
171-3 14"
172-3 17"
173-3 20"
174-3 24"
175-3 28"
176-3 30"

PIEZAS DE REEMPLAZO

170 12"
171 14"
172 17"
173 20"
174 24"
175 28"
176 30"

Par
3/8" Incluye Bracket
CAPACIDAD 15 Kg POR PAR

852 Par Reforzado 30"
2065 Bracket Pieza

1/2" Incluye Bracket
3/8"

CAPACIDAD 25 Kg POR PAR

165 Juego 2" Blanco Gris Negro
166 Juego 3" Blanco Gris Negro

JALADERA BROCHE GUILLOTINA

370 Incluye Resorte

Blanco Natural Electro



119 Resorte



Armado Rápido Plástico 2.2 mm

Sin Vinilos Sin Cortar la Altura del Plástico No Incluye Plástico



Armado Rápido Acrílico 2.8 mm

Sin Vinilos Sin Cortar la Altura del Acrílico No Incluye Acrílico



NUEVO

Altura 1.87 m

- CBP12** 1.20 m
- CBP15** 1.50 m
- CBP20** 2.00 m



Colocación sin Vinil

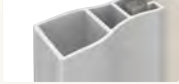

Marco Vista Colonial Ambos Lados



Rápida Instalación de Jaladera en Guía



Remaches sin Contacto al Plástico "o" Acrílico

- Herrajes Incluidos :**
- 3 Jaladeras
 - 2 Soportes Toallero
 - 2 Barras Toallero
 - 4 Cinta Doble Adherencia
 - 4 Deslizadores
 - 14 Remaches #45
 - 8 Tapones
 - 8 Pijas Marinas 10 x 1 1/2 CF
 - 4 Carretillas
- Clave:**
- JT42
 - S43
 - TDV
 - 1391
 - 38
 - 335
 - TPC
 - 108P
 - S521P

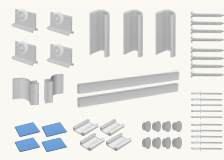

Guía Interior con Drenos Barras Toallero y Jaladeras con Perforaciones



Vista Curva "o" Recta en Barra Toallero



NUEVO

Altura 1.87 m

- CBA12** 1.20 m
- CBA15** 1.50 m
- CBA20** 2.00 m



- Herrajes Incluidos :**
- 3 Jaladeras
 - 2 Soportes Toallero
 - 2 Barras Toallero
 - 4 Cinta Doble Adherencia
 - 4 Deslizadores
 - 14 Remaches #45
 - 8 Tapones
 - 8 Pijas Marinas 10 x 1 1/2 CF
 - 4 Carretillas
- Clave:**
- JT42
 - S43
 - TDV
 - 1391
 - 38
 - 335
 - TPC
 - 108P
 - S521P

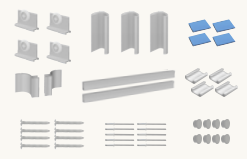

Guía Interior con Drenos Barras Toallero y Jaladeras con Perforaciones



- Altura 1.90 m
- 1444** 1.20 m
 - 1445** 1.50 m
 - 1446** 2.00 m

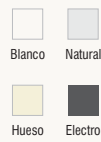

- Herrajes Incluidos :**
- Vinil Vertical
 - Vinil Horizontal
 - 4 Deslizadores
 - 4 Carretillas
 - 4 Cinta Doble Adherencia
 - 8 Tapones
 - 4 Pijas 6 x 3/4" CF
 - 8 Pijas 10 x 1" CF Mixta
 - 1 Silicón
- Clave:**
- VP11
 - VP10
 - 38
 - 521TK
 - 1391
 - 1338
 - 1285
 - 2149
 - 844



- Altura 1.85 m
- 282** 1.20 m
 - 283** 1.50 m
 - 352** 2.00 m



- Herrajes Incluidos :**
- 2 Soportes Toallero
 - 3 Jaladeras
 - 4 Cinta Doble Adherencia
 - 4 Deslizadores
 - 4 Pijas 6 x 3/4" CF
 - 6 Remaches #44
 - 8 Pijas 10 x 1" C.F. Mixta
 - 4 Carretillas Ovaladas
- Clave:**
- 122
 - 249
 - 1391
 - 38
 - 1285
 - 115
 - 2149
 - S521P

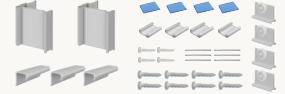

PERFILES AL CORTE

Superior 4079

- 250** 1.20 m
 - 251** 1.50 m
 - 801** 2.00 m
-

Inferior 4332

- 260** 1.20 m
 - 261** 1.50 m
 - 719** 2.00 m
-

Barra Toallero 4337

- 1856** 1 m
-

Jaladera Trompa de Elefante

- 249** Pieza
 - 249C** 50 Piezas
 - 249G** 100 Piezas
- Perfil 4112 Base Curva
-

Soporte Toallero

- 122** Pieza
 - 122C** 50 Piezas
 - 122G** 100 Piezas
-

Deslizador

- 38** Plástico
-

Tapón

- 1338** 3/8"
-

CARRETILLAS

"T" Rodaja Plana

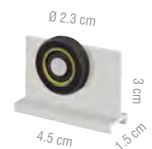

- 521TK** Pieza

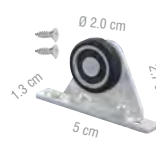

- 1009** Esp. R20

"L" Rodaja Plana

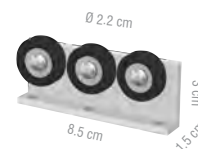

- 1539** 3 Baleros

"L" Rodaja Ovalada



- 162** Embalada

BARRA A MURO

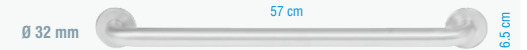

- 885** Pieza
- 885C** 6 Piezas
- 885G** 12 Piezas

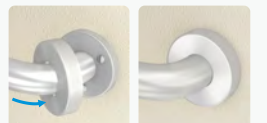

Deslizamiento Suave y Silencioso "T" Rodaja Ovalada

NUEVO



- S521P** Pieza
- S521PC** 50 Piezas
- S521PG** 100 Piezas
- 620,000 ciclos con 7 kg**

CORTINAS DE AIRE



La Cortina de Aire Minimiza la Entrada de Insectos y Ayuda a Mantener la Temperatura en Interiores



Longitud

CONTROL REMOTO



2 Velocidades

Clave:	Longitud	Alimentación	Consumo
CAF6	60 cm	220v	140 w
CAF10	1.00 m	110v 220v	180 w
CAF12	1.20 m	110v 220v	200 w
CAF15	1.50 m	110v 220v	230 w
CAF18	1.80 m	110v 220v	300 w

Pintable en Nuestros Acabados

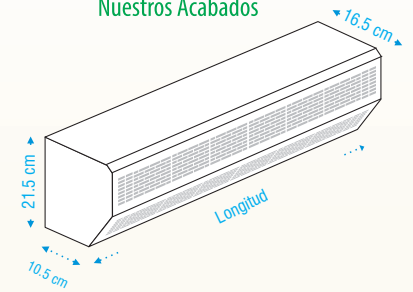

TELAS MOSQUITERO



Fibra de Vidrio

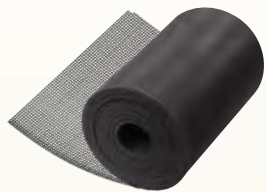

Negro Gris

Metro	1 Rollo - 29 m	4 Rollos
459 0.60 m	459R 0.60 m	459RG 0.60 m
215 0.75 m	215R 0.75 m	215RG 0.75 m
2191 0.90 m	2191R 0.90 m	2191RG 0.90 m
191 1.05 m	191R 1.05 m	191RG 1.05 m
2192 1.20 m	2192R 1.20 m	2192RG 1.20 m
2193 1.50 m	2193R 1.50 m	2193RG 1.50 m
423 1.80 m	423R 1.80 m	423RG 1.80 m
2775 2.40 m	2775R 2.40 m	2775RG 2.40 m

Aluminio



Negro Gris

Metro	Rollo 30 m
239 0.90 m	239R 0.90 m
240 1.05 m	240R 1.05 m
213 1.20 m	213R 1.20 m
177 1.50 m	177R 1.50 m

MOSQUITERO ENROLLABLE

Guía Perfil 20001



Negro Gris

	Largo	Enrollado
ME12	1.20 m	1.50 m
ME15	1.50 m	1.50 m
20006C	5.80 m	1.50 m
20006	5.80 m	2.40 m

Guía Perfil 30001



Negro Gris

	Largo	Enrollado
ME20	2.00 m	1.50 m
ME200	2.00 m	2.40 m
ME300	3.00 m	2.40 m
30006	5.80 m	2.40 m

CARRUCHAS



89

Madera

373

Plástico

RETEN MOSQUITERO

Pija 6 X 1/2



25E

Grapa Plástica

Blanco Negro

FLEJE MOSQUITERO

Desmontable



2652

RESORTES

Ø 1.8 cm Largo



Pieza

R42D	18" Derecho
R42i	18" Izquierdo
R150D	61" Derecho
R150i	61" Izquierdo

SEGURO



3120

Seguro Escarabajo



JUEGOS MOSQUITERO ENROLLABLE



BGC

VENTANA
GUILLOTINA CADENA

Acabado: Negro

Incluye:

- 4 Pijas 103P 8 x 1" CF. Tratamiento Marino
- 4 Remaches 1500 # 54 5/32" x 1/4"
- 4 Taquetes 619 Zakany
- 6 Pijas 773 de 8 x 1" C.P. Negra
- 4 Pijas 778 de 10 x 1 1/12" C.P. Negra
- 2 Barras Contrapeso p/mosquitero 25 cm BCP
- 2 Ruedas Dentadas RDE
- 2 Soleras Contrapeso 25 cm SCP
- 1 Retén a Muro Cadena SMC
- 1 Par de Tapones Cajón TC
- 1 Seguro Cadena TCS
- 1 Par de Tapones Jaladera TJV
- 4 Tapones p/pija cajón mosquitero TPC
- 2 Pares de Tapas para Contrapeso TPCP
- 1 Tapón Rueda Dentada TRD
- 1 Unión Cadena UC



BCO

VENTANA
CORREDIZO

Acabado: Negro

Incluye:

- 1 Par de Tapones Jaladera TJV
- 4 Taquetes 619 Zakany
- 1 Par de Tapones Cajón TC
- 1 Tapón Rueda Dentada TRD
- 4 Pijas 103P 8 x 1" CF. Trat. Marino
- 4 Tapones p/pija cajón mosquitero TPC
- 4 Remaches 1500 # 54 5/32" x 1/4"
- 4 Pijas 773 de 8 x 1" C.P. Negra
- 4 Pijas 778 de 10 x 1 1/12" C.P. Negra
- 2 Ruedas Dentadas RDE
- 1 Par de Jaladera y Opresor JME



RGC

PUERTA
GUILLOTINA CADENA

Acabado: Negro

Incluye:

- 4 Taquetes 619 Zakany
- 1 Tapón Rueda Dentada TRD
- 4 Pijas 103P 8 x 1" CF. Trat. Marino
- 4 Tapones p/pija cajón mosquitero TPC
- 4 Remaches 1500 # 54 5/32" x 1/4"
- 4 Pijas 773 de 8 x 1" C.P. Negra
- 2 Ruedas Dentadas RDBO
- 1 Par de Tapones Cajón TCB
- 1 Unión Cadena UC
- 1 Retén a Muro Cadena SMC
- 4 Pijas 778 de 10 x 1 1/2" C.P. Negra
- 2 Rondanas Plásticas RBO
- 1 Par de Tapones Jaladera TJP
- 2 Baleros BBO



RCO

PUERTA
CORREDIZO

Acabado: Negro

Incluye:

- 4 Pijas 103P 8 x 1" CF. Trat. Marino
- 4 Remaches 1500 # 54 5/32" x 1/4"
- 4 Taquetes 619 Zakany
- 4 Pijas 773 de 8 x 1" C.P. Negra
- 4 Pijas 778 de 10 x 1 1/2" C.P. Negra
- 2 Baleros BBO
- 2 Rondanas Plásticas RBO
- 2 Ruedas Dentadas RDBO
- 1 Par de Tapones Cajón TCBO
- 1 Par de Tapones Jaladera TJV
- 4 Tapones p/pija Cajón Mosq.TPC
- 2 Tapones para Rueda Dentada TRD

IMANES

4.8 mm
6.5 mm
7.2 mm



7.7 mm
8.3 mm
11.1 mm

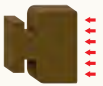

ICC
Metro



ICCC
Rollo 50 m



ICCG
2 Rollos 50 m



ICI
Metro

BLACK OUT Ancho: 2.10 m

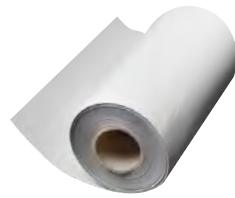

Ambas Caras Blanco
BLOB Metro
BLOBR Rollo 50 m



Ambas Caras Hueso
BLOH Metro
BLOHR Rollo 50 m

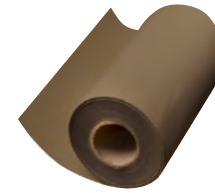

Ambas Caras Café
BLOC Metro
BLOCR Rollo 50 m

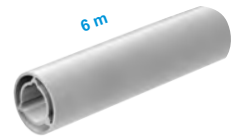

Ø Exterior 3.1 cm
Ø Interior 1.8 cm

30001

**GUÍA REFORZADA:
MOSQUITERO ENROLLABLE
Y BLACK OUT**

SELLADORES

SILICONES



Color:
Transp.

Silicón Sky Sil
300 ml Presto

- 126T** Pieza
- 126TC** 6 Piezas
- 126TG** 12 Piezas
- 126TE** 24 Piezas



Color:
Transp.

Silicón Willy
280 ml Presto

- 126P** Pieza
- 126PC** 6 Piezas
- 126PG** 12 Piezas
- 126PE** 24 Piezas

ESTRUCTURAL



Colores:
Transp.
Negro

Estructural 300 ml

- 1670** Pieza
- 1670C** 6 Piezas
- 1670G** 12 Piezas
- 1670E** 24 Piezas

ACRÍLICOS



Color:
Blanco

Acrílico Willy
280 ml Presto

- 328P** Pieza
- 328PC** 6 Piezas
- 328PG** 12 Piezas
- 328PE** 24 Piezas



Colores:
Blanco
Negro
Gris
Café

Acrílico Siliconizado
Sky Cril 300 ml Presto

- 328** Pieza
- 328C** 6 Piezas
- 328G** 12 Piezas
- 328E** 24 Piezas

ESPEJO



Color:
Amarillo

Gunther 300 ml

- 1592** Pieza
- 1592C** 24 Piezas

POLIURETANO
Sella Cristal Doble



Colores:
Blanco
Negro
Gris

Duretán 300 ml

- 872** Pieza
- 872C** 25 Piezas

POLICARBONATO



Colores:
Transp.

Policarbonato 300 ml.

- 3070** Pieza
- 3070C** 25 Piezas

BAÑOS Y COCINAS



Colores:
Blanco
Transp.

844

280 ml Pieza

LUBRICANTE
MULTIUSOS

NUEVO



2094

WD40 458 ml.

ESPUMA DE POLIURETANO



2625

500 ml.

ESPATULAS

MEJOR RENDIMIENTO
AL SELLAR



4.6 cm

4.6 cm

NUEVO

TS

Juego de 4 Espátulas
Sellado Uniforme

PISTOLAS DE
CALAFATEO



36 cm

1553
Reforzada



33.4 cm

607
Importada

Recomendada en Línea U-light, C-light, 2" y 3"

FELPA COMERCIAL



FG 1 m.

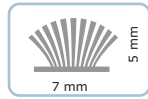

160,000 Ciclos de 75 cm

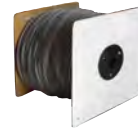

FG1

Rollo 375 m



FG4

4 Rollos de 375 m 1500 m



FG200

Rollo 200 m



FG6

6 Rollos de 200 m 1200 m



FELPAS ALTO RENDIMIENTO

HERMÉTICAS CON DIVISIÓN TEXTIL

FACILITAN EL DESLIZAMIENTO DE LAS HOJAS CORREDIZAS



NUEVO

MUY ALTO AISLAMIENTO ACÚSTICO

ALTA HERMETICIDAD AL AIRE



1,000,000 Ciclos de 75 cm

FL5 Metro
FL5R Rollo de 450 m
FL5C 3 Rollos de 450 m

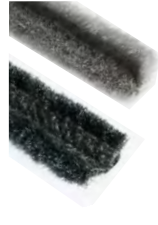

MUY ALTO AISLAMIENTO ACÚSTICO

ALTA HERMETICIDAD AL AIRE

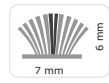

1,200,000 Ciclos de 75 cm

FL6 Metro
FL6R Rollo de 300 m
FL6C 4 Rollos de 300 m



NUEVO

MUY ALTO AISLAMIENTO ACÚSTICO

ALTA HERMETICIDAD AL AIRE

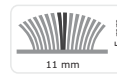

1,500,000 Ciclos de 75 cm

F5L Metro
F5LR Rollo 250 m.
F5LC 3 Rollos de 250 m

Corredizas Serie 80 Serie 100



ALTO AISLAMIENTO ACÚSTICO

ALTA HERMETICIDAD AL AIRE

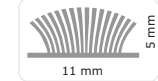

732,000 Ciclos de 75 cm

F5P Metro
F5PR Rollo 250 m.
F5P4 4 Rollos de 250 m



Corredizas Serie 80 Serie 100 Perfil 58409 de Serie 70

HERMÉTICA CON DIVISIÓN PLÁSTICA PUERTAS BATIENTES



FT6 Metro
FT6R Rollo de 300 m
FT6C 4 Rollos de 300 m



F7P Metro
F7PR Rollo de 350 m
F7P3 3 Rollos de 350 m



Perfiles :

6534 62378
16534 48416
46534 13642
66534 14321
19188 11411
7838 11412
7839 39188



F12P Metro
F12PR Rollo de 200 m
F12P4 4 Rollos de 200 m



Perfiles: 15235 20010 15236 20009 68412



FAN Metro

FANR Rollo de 275 m

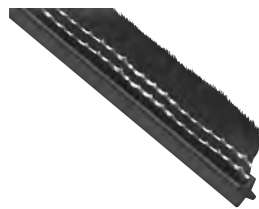

Para Perfiles:
28407 11411
628407 11412
62373 20010
662373 20011
38407 12566
638407 34715
48407 19188
648407 49188
23578 49189



F11P Metro
F11PR Rollo de 450 m
F11P3 3 Rollos de 450 m



Para Perfil 20007 y 5567

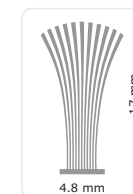

F17P Metro
F17PR Rollo de 100 m

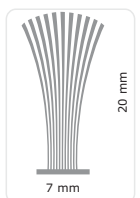

F20 Metro
F20R 100 m
F20R4 4 de 100 m

Vinil por Rollo Agregue a la Clave: **C** En Rollo de 5 Kg y **G** En Rollo de 10 Kg

PATA



Negro



Clave	Altura
VP8	8 mm
VP9	9 mm
VP10	10 mm
VP11	11 mm
VP12	12 mm
VP13	13 mm
VP14	14 mm
VP15	15 mm
VP16	16 mm
VP17	17 mm

PATA CUÑA



Negro

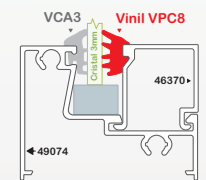

CUÑA



Línea 2"
VC177P

Negro



Clave Altura
VC10 10 mm
VC11 11 mm
VC12 12 mm
VC13 13 mm



CAMA



VCA

Negro



Se recomienda en los Perfiles:

6608	8936	9084	9135	10237	38183
6607	8586	9085	9136	10465	38182
6609	9080	9105	9139	10469	20465
7315	9083	9115	10235	38270	28183
				28270	29086



VCA3

Negro

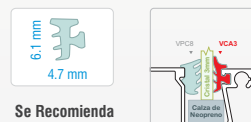

Se recomienda en los Perfiles:

9073	49074
9074	9075

CARRUCHA



Perfiletto
ALUMINUM

Instalación de ViniLOS
Sin Estirar o Dañar el Vinil

3104 Pieza
3104C 20 Piezas
3104G 40 Piezas

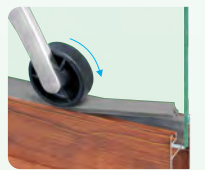

CUÑA SAN LUIS



VCS

Negro



VINIL "U"



Negro

VU6P
Metro

VU6PR
Rollo 150 m

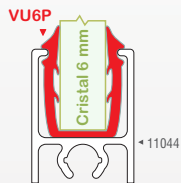

PEZUÑA

Corrediza Línea 2"
y Series 70 y 80

VPZP
Metro

VPZPR
Rollo 500 m



Interior Flexible

Contorno Rígido

Negro

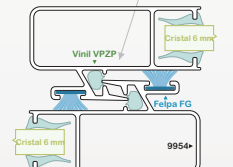
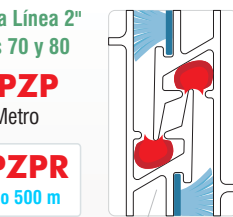
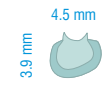

GUARDAPOLVO



VPZ

Negro



VG

Negro

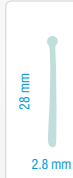

REGLA



VRE

Negro

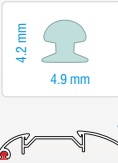

VINIL MOSQUITERO



VM35
3.5 mm

Negro

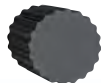

VM40
4 mm

Negro

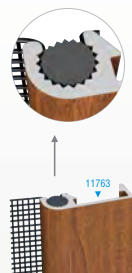

VM45
4.5 mm

Negro

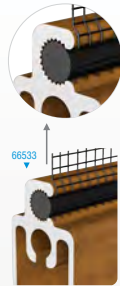

Herrería
VM50
5 mm

Negro



VINIL INTERIOR BASE RÍGIDA y ALETAS SUAVES

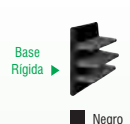

V3 Metro
V3R Rollo 500 m

Negro

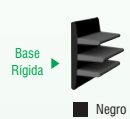
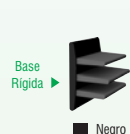

V4 Metro
V4R Rollo 400 m

Negro

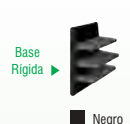
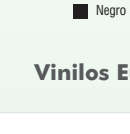

V5 Metro
V5R Rollo 300 m

Negro

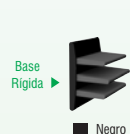

ViniLOS y Perfiles con Estrías, Logrando Mayor Tensión a la Tela Mosquitero

ViniLOS Europeos con Alta Resistencia a Rayos UV, Elegantes a la Vista y Fácil Colocación

HONGO

Base Rígida Flexible

VHP Metro Negro

VH4 Metro Negro

VH6 Metro Negro

VHE Metro Negro

VHPR Rollo 340 m

VH4R Rollo 250 m

VH6R Rollo 250 m

VHER Rollo 305 m

MAYOR HERMETICIDAD: AL AIRE, POLVO Y RUIDO POR SU VINIL VH4 EN TRASLAPES

LÍNEA 1400

HONGO Comercial

Base Rígida Flexible

VH14 Metro Negro

VH14R Rollo 200 m

VH Negro

ALETA

Base Rígida Flexible

VAP Metro Negro

VAPR Rollo 400 m

ALETA Comercial

VA Negro

VINIL RESPALDO

VR6 Metro Negro

VR7 Metro Negro

VR8 Metro Negro

VR9 Metro Negro

Serie 100

Corredizas Serie 70 y 80

Cristal Doble Serie 100

Serie 100

SANTOPRENE

RESISTENTE A RAYOS UV

STP Negro

STPR Rollo 126 m

Empaque Santoprene

Cristal 6 mm

Cristal 6 mm

14349

14350

14351

• PTR 3" x 2"

PRESUPUESTE CON MAYOR EXACTITUD

METROS APROXIMADOS POR ROLLO DE 10 Kg

PATA



Clave	Mts	Clave	Mts
VP8	290	VP13	103
VP9	236	VP14	90
VP10	170	VP15	80
VP11	139	VP16	63
VP12	120	VP17	58

CUÑA



Clave	Mts
VC10	410
VC11	350
VC12	260
VC13	230

CUÑA



Clave	Mts
VC177P	580

CUÑA SAN LUIS



Clave	Mts
VCS	420

CAMA



Clave	Mts
VCA	300
VCA3	460

PATA CUÑA



Clave	Mts
VPC8	230

ALETA



Clave	Mts
VA	750

PEZUÑA



Clave	Mts
VPZ	440

HONGO



Clave	Mts
VH	630

MOSQUITEROS



Clave	Mts
VM35	950
VM40	670
VM45	540
VM50	440

GUARDAPOLVO



Clave	Mts
VG	130

REGLA



Clave	Mts
VRE	480

RESPALDO



Clave	Mts
VR6	130
VR7	220
VR8	68
VR9	170

VINILOS ESPECIALES

SANTOPRENE



Clave	Mts
STP	126

Rollo de 7 kg

VINIL U



Clave	Mts
VU6P	150

PEZUÑA Base Rígida



Clave	Mts
VPZP	500

INTERIOR Base Rígida



Clave	Mts
V3	500
V4	400
V5	300

ALETA Base Rígida



Clave	Mts
VAPR	400

HONGO Base Rígida



Clave	Mts
VH4R	250
VH6R	250
VHPR	340

HONGO Base Rígida



Clave	Mts
VH14R	200



CABEZA FIJADORA



90P Pieza	103P Pieza	104P Pieza	105P Pieza	107P Pieza	108P Pieza
90PC 1000 Piezas	103PC 1000 Piezas	104PC 1000 Piezas	105PC 1000 Piezas	107PC 1000 Piezas	108PC 1000 Piezas
90PG 2000 Piezas	103PG 2000 Piezas	104PG 2000 Piezas	105PG 2000 Piezas	107PG 2000 Piezas	108PG 2000 Piezas

CABEZA PLANA

Tornillo Chirlato
Fijación a Muro



154P Pieza	155P Pieza
154PC 144 Piezas	155PC 144 Piezas
154PG 576 Piezas	155PG 576 Piezas



Pija Marina
Anticorrosión



Daño en Pija Comercial



PIJAS Y TORNILLOS

1 Caja Agregar "C" a la Clave

CABEZA FIJADORA GALVANIZADA

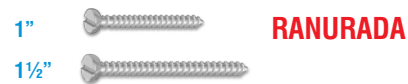

107 10 x 1" Pieza	Caja 1000 Piezas
108 10 x 1 1/2" Pieza	Caja 1000 Piezas

CABEZA FIJADORA GALVANIZADA



2147 8 X 1" Pieza	Caja 1000 Piezas
2148 8 x 1 1/2" Pieza	Caja 1000 Piezas
2149 10 X 1" Pieza	Caja 1000 Piezas
2200 10 x 1 1/2" Pieza	Caja 1000 Piezas

TORNILLOS PARA MADERA

Galvanizado

765 8 x 2 1/2" Pieza	Caja 144 Piezas
-----------------------------	-----------------

10 x 2"	
10 x 2 1/2"	
10 x 3"	

154 10 x 2" Pieza	Caja 144 Piezas
385 10 x 2 1/2" Pieza	Caja 144 Piezas
155 10 x 3" Pieza	Caja 144 Piezas

4 Cajas Agregar "G" a la Clave

CABEZA PLANA ACERO INOXIDABLE



2618 8 x 1/2" Pieza

1129P 10 x 3/4" Pieza	Caja 1000 Piezas
2620 10 X 2" Pieza	Caja 500 Piezas
2621 10 X 3" Pieza	Caja 250 Piezas

CABEZA PLANA GALVANIZADA

109P 10 x 2" Pieza	Caja 500 Piezas
---------------------------	-----------------

PUNTA DE BROCA

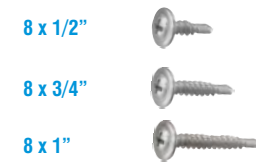

2048 8 x 1" Pieza	Caja 1000 Piezas
2049 8 x 1/2" Pieza	Caja 1000 Piezas
2050 8 x 3/4" Pieza	Caja 1000 Piezas

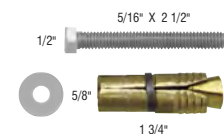

3192
Taquete de Expansión con Tornillo

TAQUETE

Perfiletto ALUMINUM

#44 1/8"x 1/4"	#45 1/8"x 5/16"
115 Pieza	335 Pieza
115C 1000 Piezas	335C 1000 Piezas
115G 2000 Piezas	335G 2000 Piezas

#48 1/8"x 1/2"	#46 1/8"x 3/8"	#56 5/32"x 3/8"
471 Pieza	410 Pieza	226 Pieza
471C 1000 Piezas	410C 1000 Piezas	226C 1000 Piezas

3.8 cm

Zakany 1/4"

619 Pieza

619C 100 Piezas

REMACHADORAS

AUMENTE SU PRESTIGIO FIJACIÓN USO RUDO

24.5 cm

R
Remachadora
2 Boquillas

Remaches y Tornillos con Rosca de Alta Resistencia

Salino

16.5 mm 27.5 mm

FRS 1 Juego *Remaches y Tornillos Allen en Acero Inoxidable*

FRSC 10 Juegos

FRSG 20 Juegos



24.5 cm

341
Remachadora

CREMALLERA DE ALUMINIO

(PAR)

28	1.00 m.
30	1.20 m.
224	1.80 m.

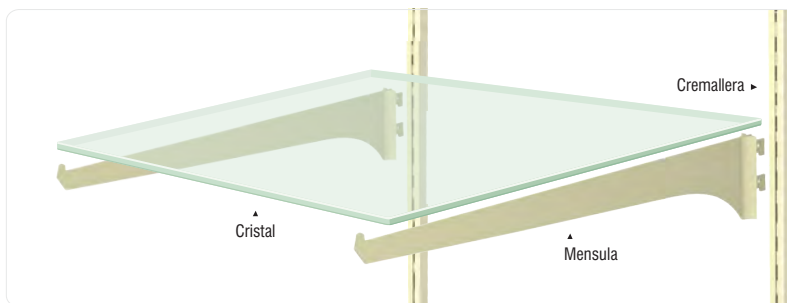

MENSULAS (PAR)

Con Respaldo

492	20 cm
496	25 cm
500	30 cm

BISAGRA

2911
Bisagra, Contra Push
y Contra Imán
Cristal 6 mm

Blanco Negro Cromo

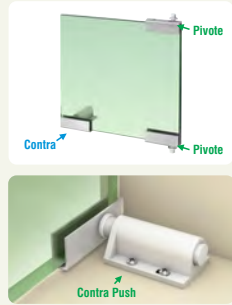
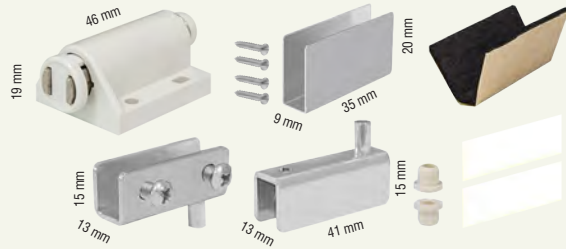

JALADERA



57
Adherible

Plástico Blanco

CARRETILLAS



1677
Importada



22
Cuerpo de Plástico



398
Española

CHAPAS

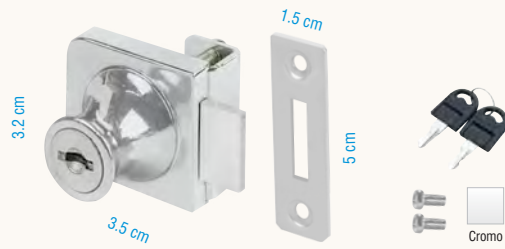
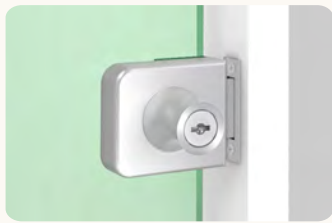

Puerta Abatible

1407 Pieza
1407C 20 Piezas
1407G 40 Piezas



Cromo



Puerta Abatible

1409 Pieza
1409C 20 Piezas
1409G 40 Piezas



Cromo

Corredizas



1840 Cromo



429 Cromo

De Empuje

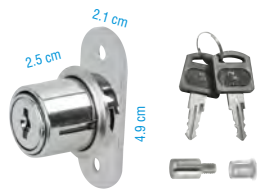

2730 Cromo



1511 Cromo

Operación Recta



14 Cromo Latón



1519 Gris

CONECTORES

Máximo 6 mm Opresor Plástico Incluido

Pieza Reemplazo

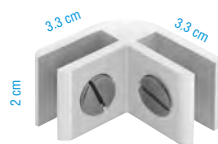

418 "L"
Blanco Natural



416 "T"
Blanco Natural

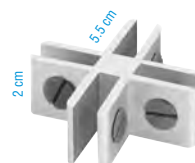

417 "Cruz"
Blanco Natural



400
Opresor Plástico
Conector 6 mm

PUERTA BATIENTE MULTIDISEÑOS

Cabezal 9207

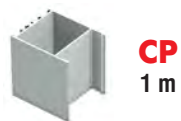

CP
1 m



Intermedio 9183



iP
1 m



Zoclo 9187



ZYC
1 m



Zoclo 19187



ZC4
1 m

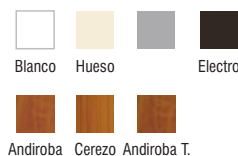

Zoclo 6" 412596



ZDL 1 m



Zoclo 10" 412599

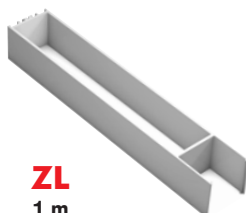

ZL
1 m



Intermedio



412602
iPL 1 m



Adaptador Intermedio



49189
ADi 1 m

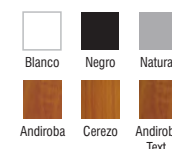

49188
TH 1 m



Sello de Hermeticidad 1 Felpa



19188
SHT 1 m



Sello de Hermeticidad 3 Felpas



PUERTA BATIENTE SAN LUIS



ASL 1 m

Adaptador Intermedio 79189



iSL 1 m

Intermedio 79183

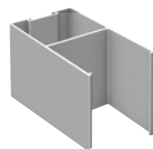

ZSL 1 m

Zoclo 79187



ZSL4 1 m

Zoclo 4" 89187



ZSL6 1 m

Zoclo 6" 712596



PUERTA BATIENTE U - LIGHT / C - LIGHT / 2"

Zoclo Cabezal
7838



ZE 1 m
Natural Mate Blanco Electro

Intermedio
7837



iPF 87 cm
Natural Mate Blanco Electro

Zoclo Cabezal
7839

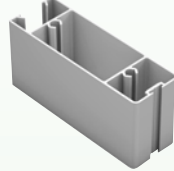

ZEC 1 m
Natural Mate Blanco Electro

PERFILES 7838 Y 7839 RECIBEN FELPA F12P REDUCIENDO ENTRADA DE POLVO E INSECTOS



PUERTA BATIENTE COMERCIAL

Cabezal
69207



195 1 m.

Blanco Hueso Natural Mate Negro
Electro Cerezo Nogal Nogal Text.
Pino Sin Nudo

Intermedio
69183



196 1 m.

Blanco Hueso Natural Mate Negro
Electro Cerezo Nogal Nogal Text.
Pino Sin Nudo

Zoclo
69187



197 1 m.

Blanco Hueso Natural Mate Negro
Electro Nogal Text. Cerezo Nogal
Pino Sin Nudo

TAPAS TUBO RECTANGULAR

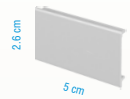

TT2
Instalación en: 62521
Cortado del Perfil: 1215

Natural Mate Nogal Text. Cerezo Text.

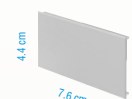

TL3
Instalación en: 62522 - 2522
Cortado del Perfil: 1214

Natural Mate Nogal Text. Cerezo Text.

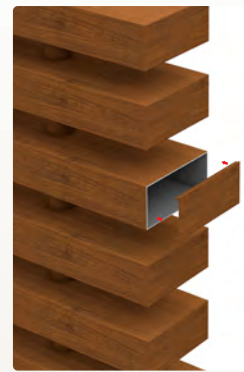

NUEVO

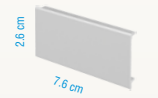

TT3
Instalación en: 62516
Cortado del Perfil: 1215

Natural Mate Nogal Text. Cerezo Text.



TL4
Instalación en: 62520 - 2520
Cortado del Perfil: 1214

Natural Mate Nogal Text. Cerezo Text.

NUEVO

CV3
Pieza

Natural Mate



Instalación en: 2533
Cortado del Perfil: 12523

TAPAS TUBO CUADRADO



T62
Pieza

Natural Mate



Instalación en Tubo Cuadrado: 2362 y 62362
Cortado del Perfil: 1215

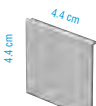

T64
Pieza

Natural Mate



Instalación en Tubo Cuadrado: 2364
Cortado del Perfil: 1214

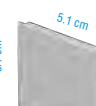

T56
Pieza

Natural Mate



Instalación en Tubo Cuadrado: 2356
Cortado del Perfil: 12523

TAPAS VIGA

NUEVO



CV2
Pieza

Natural Mate



Instalación Viga 12525
Cortado del Perfil: 12523

NUEVO



CV
Pieza

Natural Mate



Instalación Viga 12526 y 612526
Cortado del Perfil: 12524



CVR
Pieza

Natural Mate



Instalación Viga 12529
Cortado del Perfil: 12527

MOLDURAS DE FIJACIÓN



TF2 Pieza
Cortado del Perfil: 64052

Natural Mate
Linea 2"
- Light Hermética
- Comercial Hermética

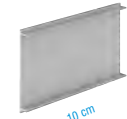

TF3 Pieza
Cortado del Perfil: 67317

Natural Mate
Linea 3"
- Light Hermética
- Comercial Hermética

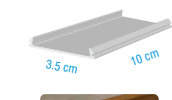

TFM
Pieza 10 cm

Perfil 9903
Natural Mate

TAPA BISAGRA

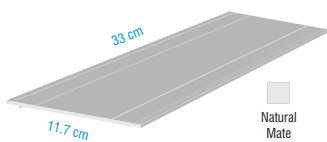

3125
Pieza

Perfil: 12591

SOPORTE EN ARMADO

PUERTA MONUMENTAL



TPM
Pieza

Cortado del Perfil: 2503

Natural Mate



TPM

SARDINELES

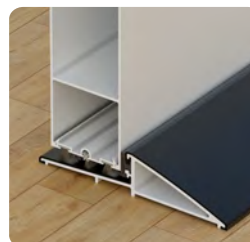

PSB

Empaque Sardinel Base 3 mm

PSR

Empaque Sardinel Rampa 3 mm



3"

199 1 m
Natural Mate Blanco Electro Negro

Perfil 4042



4"

198 1 m

Natural Mate Electro

Perfil 4043

CANCEL DE BAÑO CORREDIZO Y BATIENTE



EB Pieza
EBC 80 Piezas
EBG 160 Piezas

Perfiles: 11035, 9756 y 6854

AJUSTA Y CIERRA EL CORTE



MARCOS: 11035, 9756 Y 6854



NUEVO
CHM
Pieza



VENTANA BATIENTE Y PROYECCIÓN SERIE 35 y 2"

AJUSTA Y CIERRA EL CORTE

Escuadra EM35 en Marco

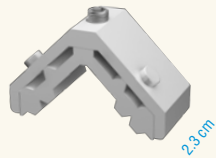

EM35 Pieza
EM35C 50 Piezas
EM35G 100 Piezas



Perfiles : 32274, 32276, 42274, 52274, 42276, 22277

AJUSTA Y CIERRA EL CORTE

Escuadra EC35 en Contramarco

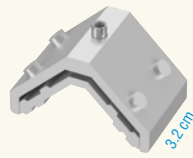

EC35 Pieza
EC35C 50 Piezas
EC35G 100 Piezas



Perfiles : 22273, 42273, 9091, 69091

TROQUEL
Serie 35 y 2"



CH35
Pieza

VENTANA BATIENTE Y PROYECCIÓN LÍNEA 3", SERIES 50, 70, 80 y 100

AJUSTA Y CIERRA EL CORTE

Escuadra EM50 en Marco

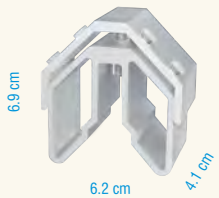

EM50 Pieza
EM50C 20 Piezas
EM50G 40 Piezas

Perfil : 54395

Armar El Marco de la Hoja con Escuadra de Botón Hasta 20 Kg.

Más de 20 Kg. Armar con Escuadra de Aluminio

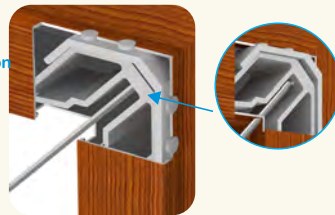

AJUSTA Y CIERRA EL CORTE

Escuadra EC50 en Contramarco



EC50 Pieza
EC50C 20 Piezas
EC50G 40 Piezas

Perfiles : 9130, 54396, 74396 y 13396.

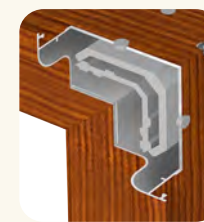

TROQUEL
Líneas 3", 50, 70, 80 y 100

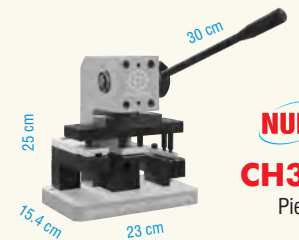

NUEVO
CH3571
Pieza

PUERTA FERRARA



ET

Escuadra Batiente Puerta Ferrara
Perfiles: 9109 y 9110

LÍNEA 1400

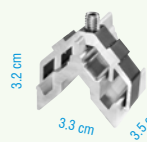

EV14 Pieza
Perfiles : 41401 y 41402



EP14 Pieza
Perfiles : 41406 y 41407



CH14
Troquel Línea 1400
Pieza

MOSQUITERO

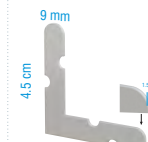

39 Pieza
39C 1000 Piezas
39G 2000 Piezas

Acero



1781 Pieza
1781C 1000 Piezas
1781G 2000 Piezas

Aluminio



ES Pieza
ESC 1000 Piezas
ESG 2000 Piezas

Sifón Acero

Blanco Hueso Natural Café Negro

U LIGHT / C-LIGHT

ARMADO RÁPIDO MAYOR FIRMEZA MEJOR PRESENTACIÓN DIFERENTES COLORES

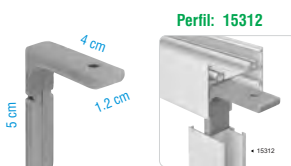

1069 Pieza
Blanco Gris Negro Café

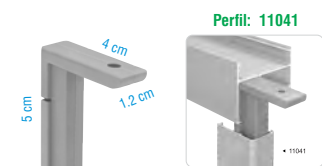

1070 Pieza
1070C 20 Piezas
1070G 40 Piezas

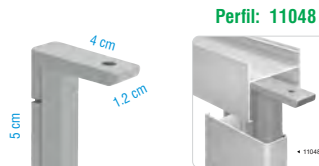

1071 Pieza
1071C 20 Piezas
1071G 40 Piezas

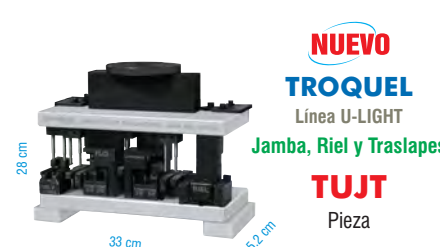

NUEVO
TROQUEL
Línea U-LIGHT
Jamba, Riel y Traslapes
TUJT
Pieza



NUEVO
TROQUEL
Línea C-LIGHT
Jamba, Riel y Traslapes
TCJT
Pieza



¿OTRA VEZ SE EQUIVOCÓ CORTANDO ÁNGULOS?

Ya no pierda tiempo, ni material por Ángulos Mal Cortados. Ahora tan solo elija las Escuadras que necesita y olvídense de problemas.



PROTEJA SU SEGURIDAD

No se arriesgue o exponga a sus trabajadores a sufrir algún accidente cortando ángulos.

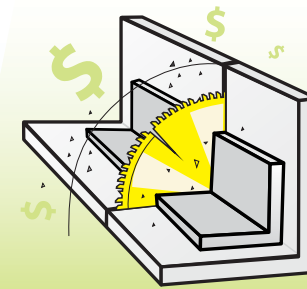

¡YA NO GASTE EN DISCOS!

Con nuestras escuadras olvídense de gastar en discos, mano de obra y electricidad.

TUBOS Escuadras Cortadas del Perfil 1311

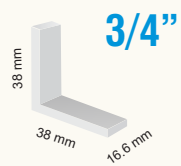

1566 Pieza
1566C 200 Piezas
1566G 400 Piezas

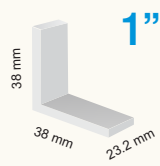

1567 Pieza
1567C 200 Piezas
1567G 400 Piezas

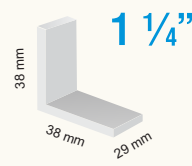

1568 Pieza
1568C 200 Piezas
1568G 400 Piezas

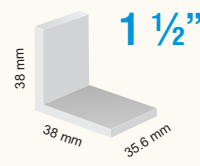

1569 Pieza
1569C 200 Piezas
1569G 400 Piezas

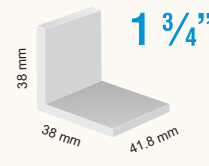

1570 Pieza
1570C 100 Piezas
1570G 200 Piezas

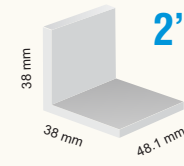

1571 Pieza
1571C 100 Piezas
1571G 200 Piezas

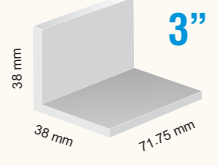

1572 Pieza
1572C 100 Piezas
1572G 200 Piezas

MOSQUITEROS

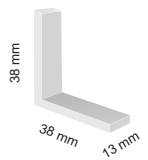

ESM Pieza
Perfil 46534

Cortado del Perfil: 1311

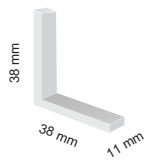

EM18 Pieza
Perfil 18930

Cortado del Perfil: 1311

PUERTA BATIENTE COMERCIAL

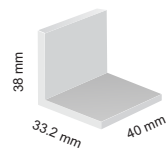

1577 Pieza
1577C 100 Piezas
1577G 200 Piezas

Cortado del Perfil: 21311

VENTANA PROYECCIÓN 2"

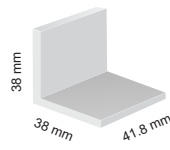

ES42
Perfil: 8936

Cortado del Perfil: 1311

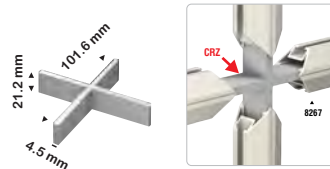

CRZ Pieza
CRZC 50 Piezas
CRZG 100 Piezas

Cortado del Perfil: 2318



Perfiles
8267 y 8271

RETÍCULA DOBLE

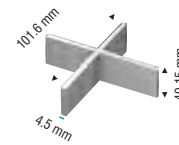

CRZM
Perfil 13646

Cortado del Perfil: 2318

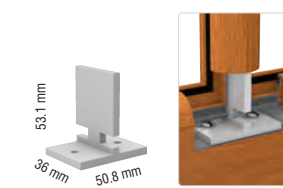

TZ100
Tee Zoclos Serie 100

Cortado del Perfil: 2317

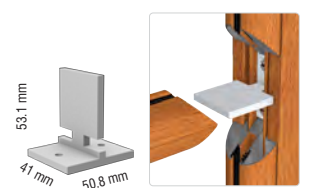

TC100

Tee Cercos Serie 100

Cortado del Perfil: 2317

SERIE 35 VENTANA BATIENTE Y PROYECCIÓN

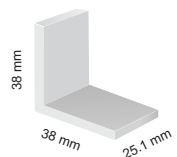

ES35 Pieza
ES35C 200 Piezas
ES35G 400 Piezas

Perfil: 22276, 12276, 12274, 22274, 22277

Cortado del Perfil: 1311

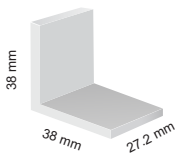

ES27

Pieza

Perfil: 32274, 32276,
42274 y 42276

Cortado del Perfil: 1311

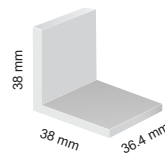

2994 Pieza
2994C 200 Piezas
2994G 400 Piezas

Perfil: 22273, 52273 y 42273

Cortado del Perfil: 1311

SERIE 50 VENTANA BATIENTE Y PROYECCIÓN

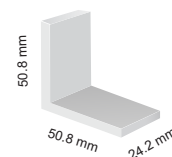

ES24 Pieza
ES24C 100 Piezas
ES24G 200 Piezas

Perfil: 24395 y 54395

Cortado del Perfil: 1318

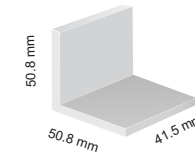

ES41 Pieza
ES41C 100 Piezas
ES41G 200 Piezas

Perfil: 24395 y 54395

Cortado del Perfil: 1318

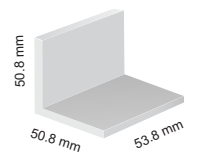

ES53 Pieza
ES53C 100 Piezas
ES53G 200 Piezas

Perfil: 24396 y 54396

Cortado del Perfil: 1318



Listas para el Armado.
Elija la Medida que Necesite
y haga su Pedido.



MARCOS Y BATIENTES

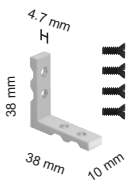

295

Económica con Barreno
Armado con Tornillo (870)

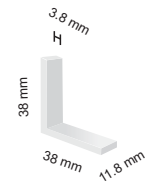

1573 Pieza
1573C 200 Piezas
1573G 400 Piezas

Cortado del Perfil: 1311

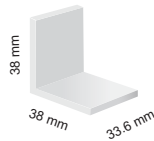

ES33 Pieza
Perfil 9069

Cortado del Perfil: 1311

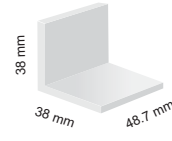

ES49 Pieza
ES49C 100 Piezas
ES49G 200 Piezas

Perfil 4044, 9256 y 28591

Cortado del Perfil: 1311

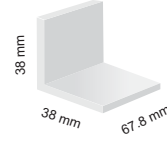

2001 Pieza
2001C 100 Piezas
2001G 200 Piezas

Perfil : 12618 y 22757

Cortado del Perfil 1311

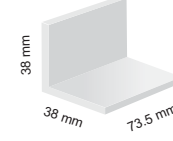

1998

Perfil 9244, 9129,
69244 y 12522

Cortado del Perfil: 1311

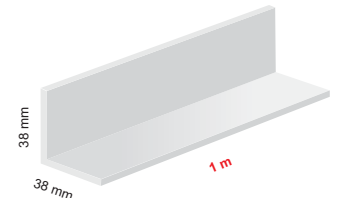

1

Ángulo para Escuadra **1m**

Sin Anodizar

Cortado del Perfil: 1311

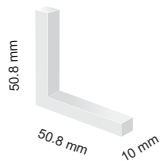

EMR

Perfil 22270

Cortado del Perfil: 1318

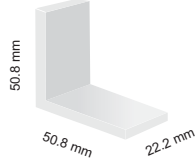

ES22

Perfil 22271

Cortado del Perfil: 1318

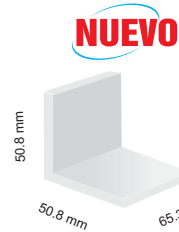

E12531

Perfil 12531

Cortado del Perfil: 1318

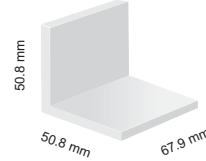

ES68

Perfil 32508

Cortado del Perfil: 1318

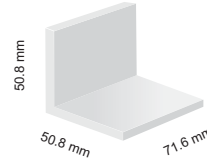

2005

Perfil 22619 y 9117

Cortado del Perfil: 1318

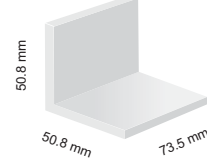

2009

Perfil 9245

Cortado del Perfil: 1318

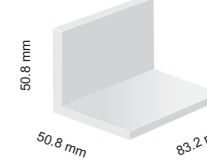

2002N

Perfil 19242 y 29243

Cortado del Perfil: 1318

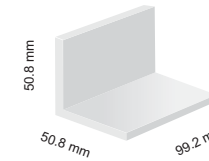

2004

Perfil 12619

Cortado del Perfil: 1318

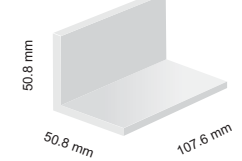

E9246

Perfil 9246

Cortado del Perfil: 1318

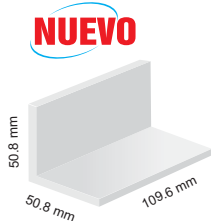

E14386

Perfil 14386

Cortado del Perfil: 1318

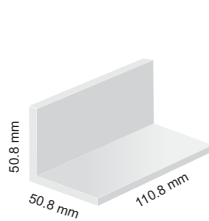

2002

Perfil 9242 Y 69246

Cortado del Perfil: 1318

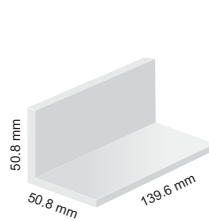

2010

Perfil 19243

Cortado del Perfil: 1318

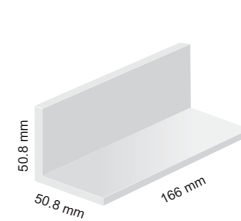

2008 Pieza
2008C 50 Piezas
2008G 100 Piezas

Perfil: 9243, 23612 y 8243

Cortado del Perfil: 1318

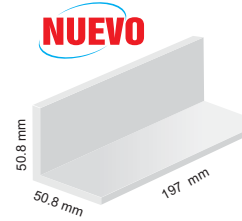

E12526

Perfil: 12526

Cortado del Perfil: 1318

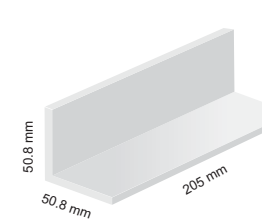

EPV

Perfil 12529

Cortado del Perfil: 1318

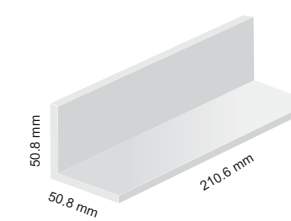

EPC

Perfil 12530

Cortado del Perfil: 1318

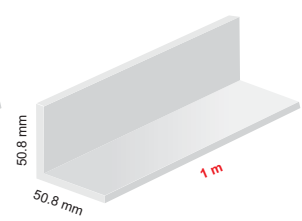

1G

2" X 2" X 1/4" **1 m**

Cortado del Perfil: 1318

Sin Anodizar



CORTADORA MANUAL
S180

120 v - 60 Hz
Ø de la Hoja 3 3/8" (85 mm)
Profundidad de Corte Max. 27 mm

33 cm
13 cm



TALADRO

2265
Rotomartillo Dewalt 1/2"
650 W - 2800 RPM



AVELLANADORES

627
1/2"
4.7 cm

718
718C
718G
Carburo de Tungsteno 1/2"
PIEZA
20 PIEZAS
40 PIEZAS

NUEVO

Avellanado

BROCAS ALTA VELOCIDAD

403 1/8" 7 cm

404 9/64" 7.5 cm

405 5/32" 8 cm

401 1/4" 10.5 cm

517 1/4" x 6" 15 cm

BROCA PARA CONCRETO

TALADRO ATORNILLADOR INALÁMBRICO



2886
Makita 18 V

Incluye:
1 Taladro - atornillador
1 Punta (plana - cruz)
1 Estuche
2 Baterías
1 Cargador

PUNTAS

1950
Punta de Cruz 2"

1416
Punta de Cruz 6"

FLEXÓMETROS



FD Digital 5 m

7.3 cm
7.8 cm

Medidas:
Centímetros
Pulgadas
Pies

Hold: Mantiene la Medida Fija en la Pantalla

Sentido de la Medida (Inicio de flexómetro / Final de flexómetro)

Muestra la Mitad de la Medida Total

Panel de Funciones

Memoria 1, Memoria 2

Pantalla Digital

Freno de Cinta

Función para Tomar Medidas Exteriores

Función para Tomar Medida Incluyendo el Cuerpo del Flexómetro



Perfiletto
ALUMINUM

USO RUDO

CiN
5 m

DISTANCIÓMETRO



DL
Distanciómetro Láser
Rango de Medición : 0.15 a 30 m

10.4 cm
4 cm
2.4 cm

EXACTOS



2335

3179
Repuesto 2335

14.5 cm

GARFIOS



1863
1863C
1863G
Doble Gancho
Pieza
30 Piezas
60 Piezas

14.5 cm

PINZA DE PRESIÓN



1818
Repuesto

1987
Jetón Irwin



CARRUSEL CON CAPACIDAD DE 6 FRESAS

ESPACIOS PARA 4 FRESAS ADICIONALES

INCLUYE: MANUAL E INSTALACIÓN



FREM

Trifásico 220 volt

Peso: 260 Kg

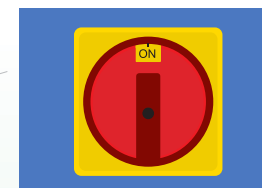

Perilla de Encendido



Salida de Rebaba

Pedal de Arranque

FRESAS



TRASLAPES 2"
Rebaje Superior



CONTRAMARCOS 2"
Económica, Light y Comercial
Rebaje Superior



CONTRAMARCOS 2" y 3"
Rebaje Inferior



CONTRAMARCOS 3"
Económica, Light y Comercial
Rebaje Superior



TRASLAPES 3"
Rebaje Superior



TRASLAPES Y CERCOS CHAPA SERIE 70
Rebaje Superior e Inferior



CONTRAMARCOS 3" PLUS
Rebaje Superior



CONTRAMARCOS 3" PLUS
Rebaje Inferior



TRASLAPE Y CERCOS CHAPA 3" PLUS
Rebaje Superior



TRASLAPE Y CERCOS CHAPA 3" PLUS
Rebaje Inferior



TRASLAPES Y CERCOS CHAPA SERIE 80
Rebaje Superior e Inferior



TRASLAPES Y CERCOS CHAPA SERIE 100
Rebaje Superior e Inferior



CERCOS CHAPA PUERTA BATIENTE MULTIDISEÑOS
Rebaje Superior e Inferior



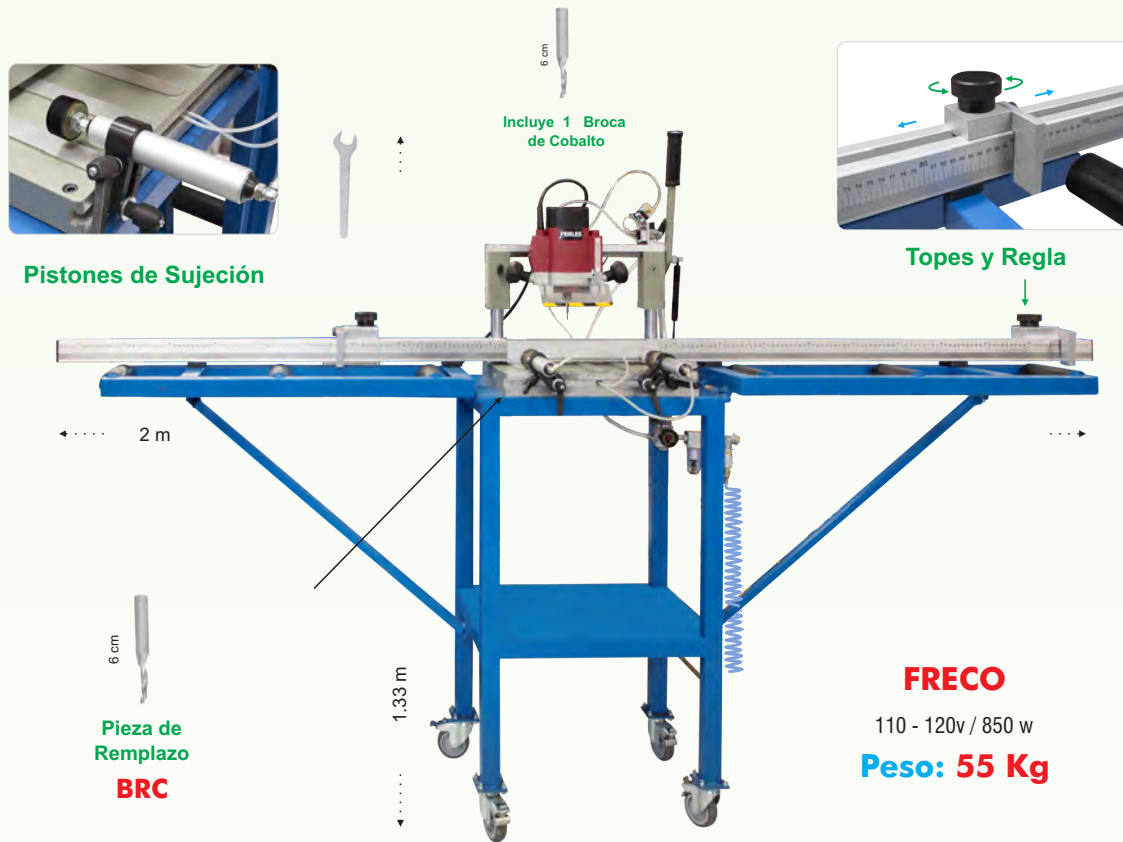

MONTAJE DE PLACA

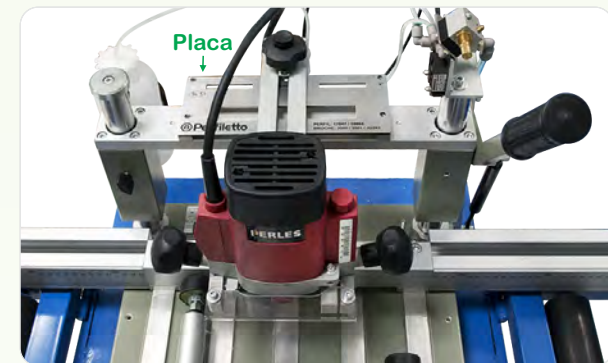

Número de Placa

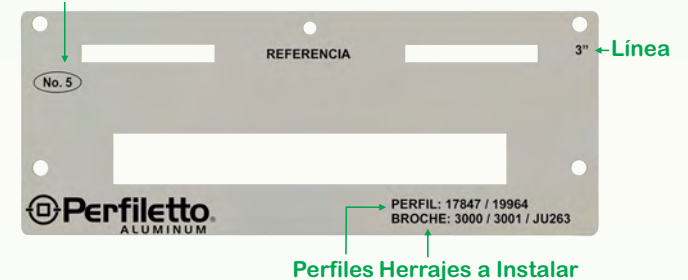

PLACAS GUÍA NO INCLUIDAS CON LA MAQUINA

PERFIL A MAQUILAR	HERRAJE A COLOCAR	CLAVE	PERFIL A MAQUILAR	HERRAJE A INSTALAR	CLAVE	PERFIL A MAQUILAR	HERRAJE A INSTALAR	CLAVE
11048	3000 / 3001 / JU263	PLACA 1	33582/64083	JE266	PLACA 30	79203	2003P	PLACA 59
7821/67821	3000 / 3001 / JU263	PLACA 2	7847/9964	JE267	PLACA 31	412542	2003P	PLACA 60
17821	3000 / 3001 / JU263	PLACA 3	17847/19964	JE267	PLACA 32	412540	1993	PLACA 61
7847 / 9964	3000 / 3001 / JU263	PLACA 4	28409/28411/28419/28421	JE267	PLACA 33	412544	1993	PLACA 62
17847 / 19964	3000 / 3001 / JU263	PLACA 5	38409/38411/38419/68409	JE267	PLACA 34	412540	BP	PLACA 63
7847/ 9964	247/JE246/U246/3101/3100/244/245	PLACA 6	33580/44083/74083	JE267	PLACA 35	412544	BP	PLACA 64
17847 / 19964	247/JE246/U246/3101/3100/244/245	PLACA 7	33582/64083	JE267	PLACA 36	28409/28411/28419/28421	SMS22	PLACA 65
28409 /28419	247/JE246/U246/3101/3100/244/245	PLACA 8	9204/69204/79204	458	PLACA 37	33580/33582/64083/74083	SMS22	PLACA 66
28411 /28421	247/JE246/U246/3101/3100/244/245	PLACA 9	46901	458	PLACA 38	28409/28419	SMS45	PLACA 67
68409 / 38409 / 38411/38419	247/JE246/U246/3101/3100/244/245	PLACA 10	17847/19964	549P	PLACA 39	33582/64083	SMS45	PLACA 68
33580/74083/13580/14083	247/JE246/U246/3101/3100/244/245	PLACA 11	46901	549P	PLACA 40	33580/33582/64083/74083	SME22	PLACA 69
33582/64083/23582/24083	247/JE246/U246/3101/3100/244/245	PLACA 12	9204/79204/69204	549P	PLACA 41	33582/64083	SME45	PLACA 70
11048	914	PLACA 13	9236	549P	PLACA 42	33582/64083	UCR	PLACA 71
7821/67821	914	PLACA 14	79203	549P	PLACA 43	22273/32273/42273/52273	805PD/805PI	PLACA 72
17821	914	PLACA 15	412540	549P	PLACA 44	54396	805PD/805PI	PLACA 73
7847/9964	914	PLACA 16	412542	549P	PLACA 45	412540/412542/412544	2220	PLACA 74
17847/19964	914	PLACA 17	412544	549P	PLACA 46	69091	805PD/805PI	PLACA 75
7847/9964	945 / 911 / U911T	PLACA 18	7847/9964	1024/1036	PLACA 47	9130	805PD/805PI	PLACA 76
17847/19964	945 / 911 / U911T	PLACA 19	9204/69204/79204	1024/1036	PLACA 48	412540	2003P	PLACA 77
28409/28419	945 / 911 / U911T	PLACA 20	9236	1024/1036	PLACA 49	412544	2003P	PLACA 78
28411/28421	945 / 911 / U911T	PLACA 21	17847/19964	1024/1036	PLACA 50	6534/46534/16534/26534	JU263	PLACA 79
68409/38409/38411/38419	945 / 911 / U911T	PLACA 22	46901	1024/1036	PLACA 51	6534/16534/46534	U246	PLACA 80
33580/74083/13580/14083/44083	945 / 911 / U911T	PLACA 23	79203	1024/1036	PLACA 52	11048/67821/8320/7821	2827	PLACA 81
33582/64083	911 / 945 / U911T	PLACA 24	412540	1024/1036	PLACA 53	79205	BP	PLACA 82
7847/9964	JE266	PLACA 25	412542	1024/1036	PLACA 54	79205	549P	PLACA 83
17847/19964	JE266	PLACA 26	412544	1024/1036	PLACA 55	79205	1024/1036	PLACA 84
28409/28411/28419/28421	JE266	PLACA 27	9204/69204/79204	2003P	PLACA 56			
38409/38411/38419/68409	JE266	PLACA 28	9236	2003P	PLACA 57			
33580/44083/74083	JE266	PLACA 29	17847/19964	2003P	PLACA 58			



LECTOR DIGITAL

TD

Tope Digital 3 m - 220 v

Lector con Precisión
Décimas de Milímetro

Corte Máximo: 3.50 m
Peso Total: 124 Kg

Lector Digital

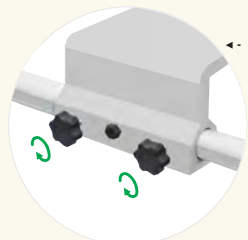

Perillas de Ajuste

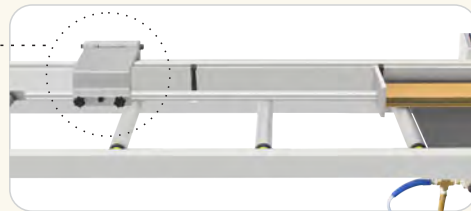

Bastón de Ajuste

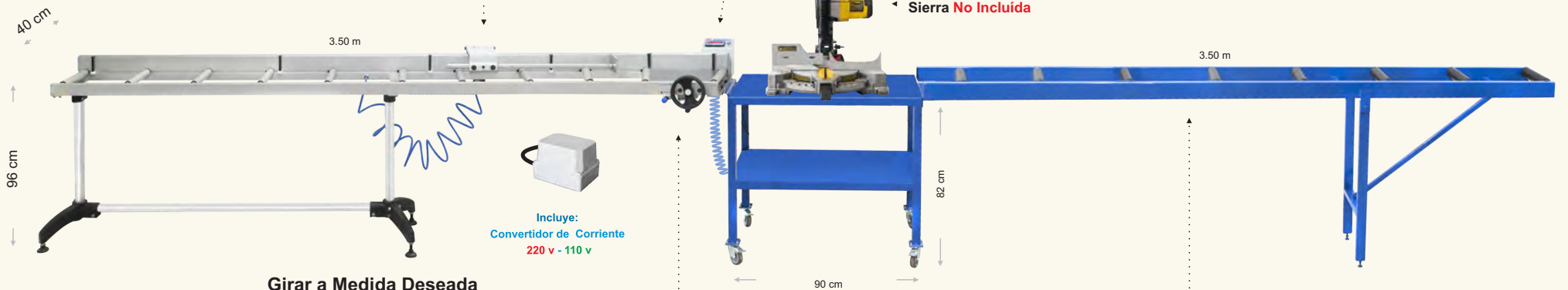

Sierra No Incluida

Incluye:
Convertidor de Corriente
220 v - 110 v

Girar a Medida Deseada



Bloqueo de Medida

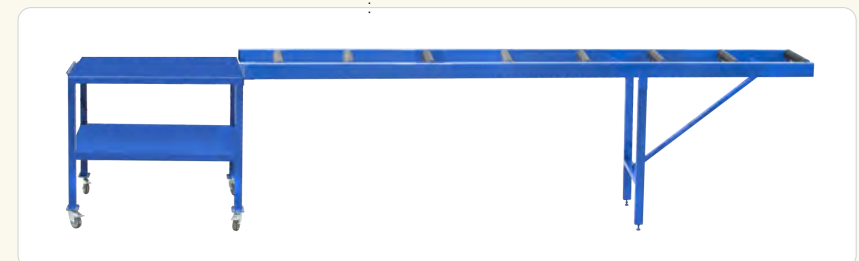

Incluye: Mesa de Corte con Rodillos

DISCOS DE CORTE ALUMINIO

Ø 10"



2207
Makita 100 Dientes
Carburo de Tungsteno
Ø Interior: 5/8"



949
Dewalt 80 Dientes
Ø Interior: 1"
Adaptadores de: 1", 5/8", 3/4"



948
Dewalt 100 Dientes
Ø Interior: 1"
Adaptadores de: 1", 5/8", 3/4"

Ø 12"



2408
Dewalt 100 Dientes
Ø Interior: 1 1/8"
Adaptadores de: 1", 5/8", 3/4"



2282
Makita 100 Dientes
Ø Interior: 1"

LUBRICANTE
PARA DISCOS
DE CORTE



10X
500 ml

5 TONELADAS DE PRESIÓN



10 TONELADAS DE PRESIÓN

Panel de Control

Altura
29.5 cm - 26.5 cm

Ø 89 cm

Carrera Máxima 3 cm

Seguro de Base Giratoria

Interruptor de Corriente

Aceite Hidráulico Incluido

PH
Prensa Hidráulica Giratoria 220 v
Peso: 380 Kg

Pedal de Accionamiento

Incluye: Recolector de Cortes

Panel de Control

Altura
29.5 cm - 24.5 cm

Ø 89 cm

Carrera Máxima 6 cm

Seguro de Base Giratoria

Interruptor de Corriente

Aceite Hidráulico Incluido

PH10
Prensa Hidráulica Giratoria 220 v
Peso: 470 Kg

Pedal de Accionamiento

Incluye: Recolector de Cortes

TROQUELES

LÍNEA 2"

28 cm

18.5 cm

T2CTT
Peso: 24 Kg

LÍNEA 3"

28.5 cm

19 cm

T3CTT
Peso: 24 Kg

SERIE 70

31 cm

20.5 cm

T70CT
Peso: 85 Kg

SERIE 80

30 cm

20.5 cm

T80CT
Peso: 80 Kg

SERIE 100

27.5 cm

T100CT
Peso: 90 Kg

28 cm

18 cm

T2JRT
Peso: 20 Kg

27.5 cm

18 cm

T3JRT
Peso: 42 Kg

30 cm

19 cm

T70J
Peso: 80 Kg

30 cm

19 cm

T80J
Peso: 80 Kg

30.8 cm

28 cm

T100J
Peso: 85 Kg

“Si Usted Desea Algún Color de la Carta RaI, Solicite Información”



1000 55 Acabados

7.3 cm
10 cm

MS
Muestra Solera

ACTUALICE
Su Muestrario con Nuestros Nuevos Acabados

ANODIZADOS



PINTURA ELECTROSTÁTICA

SUBLIMADOS MADERA

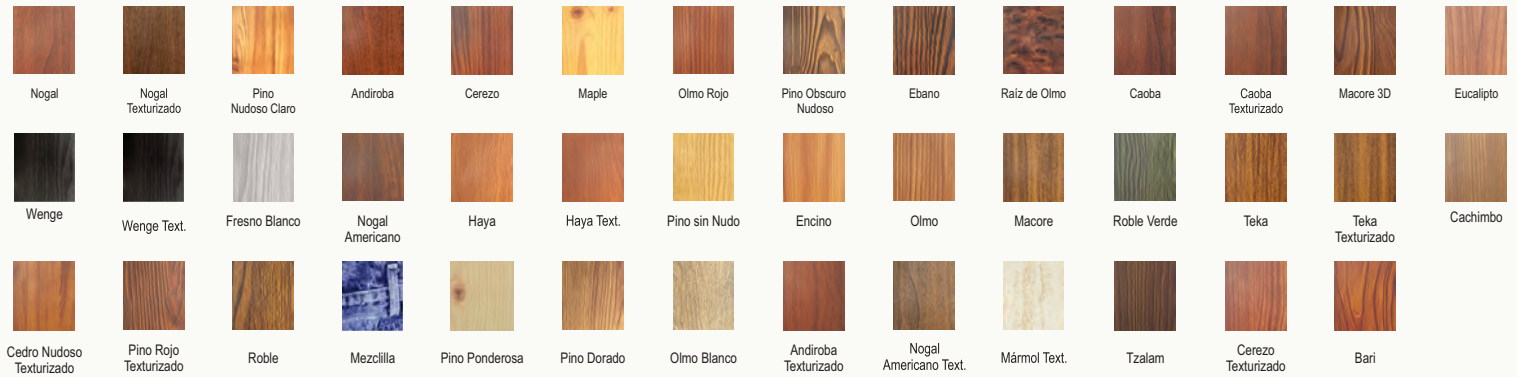

MARCADORES PARA DETALLE

Mayor Adherencia
Metal y Madera



3111



3111P

ESPESOR 1 1/2"



ESCOLAR

PT2 0.90 x 2.40 m



LISA

PT1 0.90 x 2.10 m

PT3 0.83 x 2.10 m

PT27 0.70 x 2.10 m

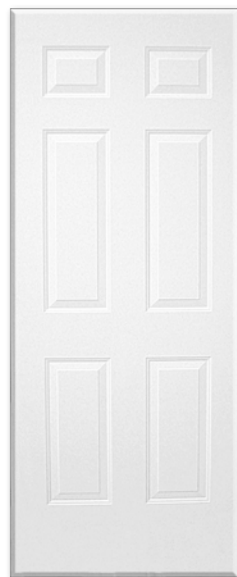

**CLÁSICA
6 PANELES**

PT6 0.83 x 2.10 m

PT7 0.90 x 2.10 m

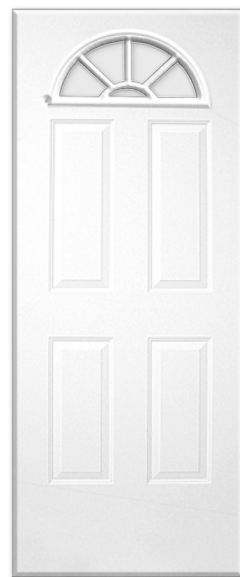

**CLÁSICA
MEDIA LUNA
4 PANELES**

PT4 0.83 x 2.10 m

PT5 0.90 x 2.10 m



NUEVO MDF DOS VISTAS

Medida: 1.22 m X 2.44 m **Espesor : 5.5 mm**



P500
Blanco



P501
Arena

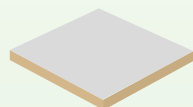

P505
Gris

**Aislante Térmico y Acústico
FOAMULAR**



FOM
Medida: 1.22 m X 2.44 m
Espesor : 1 1/2"

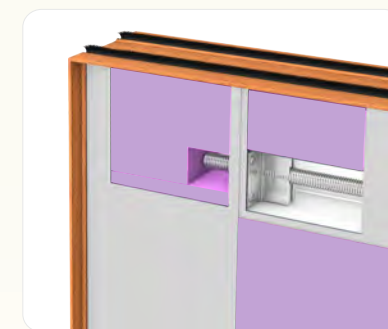

**Venta al Corte para Perfiles
de Puerta Multidiseños**

F412542	4.4 cm	F9187	3.4 cm
F412540	7.6 cm	F19187	5.7 cm
F412544	9.1 cm	F412596	10.7 cm
F412545	16.7 cm	F412599	20.7 cm

Largo: 2.44 m

GRABADO: MOSAICO



Champagne

P349 (0.70 m)
P350 (0.80 m)
P351 (1.00 m)
P352 (1.20 m)

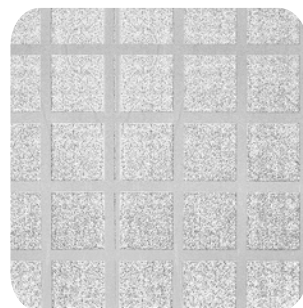

Cristal

P345 (0.70 m)
P346 (0.80 m)
P347 (1.00 m)
P348 (1.20 m)



Opalino

P5 (0.70 m)
P6 (0.80 m)
P7 (1.00 m)
P8 (1.20 m)

OPALEN

GRABADO: DELFÍN



Azul

N25 (0.70 m)
N26 (0.80 m)
N27 (1.00 m)
N28 (1.20 m)



Bronce

N21 (0.70 m)
N22 (0.80 m)
N23 (1.00 m)



Cristal

N29 (0.70 m)
N31 (1.00 m)
N32 (1.20 m)



Opalino

N13 (0.70 m)
N14 (0.80 m)
N15 (1.00 m)



Humo

N19 (1.00 m)

GRABADO: FILIGRANA



Aqua

P61 (0.70 m) P63 (1.00 m)
P62 (0.80 m) P64 (1.20 m)



Azul

P50 (0.80 m)
P51 (1.00 m)

GRABADO: OLIVO PASTEL



Durazno

P39 (1.00 m)



Aqua

P33 (0.70 m)

GRABADO: LLUVIA



Cristal

P173 (0.70 m) P175 (1.00 m)
P174 (0.80 m) P176 (1.20 m)



Bronce

P192 (1.20 m)

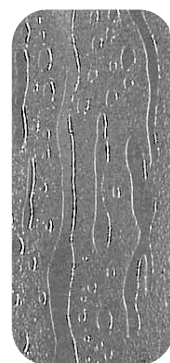

Humo

P186 (0.80 m)



Azul

P184 (1.20 m)

GRABADO: DOMINÓ

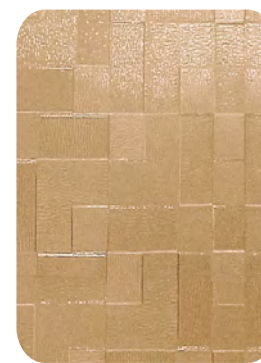

Bronce

P109 (0.70 m) P111 (1.00 m)
P110 (0.80 m) P112 (1.20 m)



Humo

P105 (0.70 m)
P106 (0.80 m)
P107 (1.00 m)

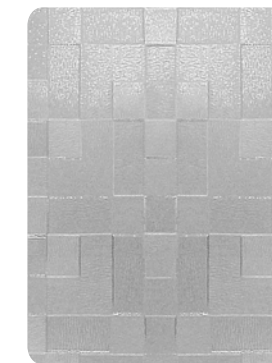

Cristal

P145 (0.70 m)
P148 (1.20 m)

GRABADO: GAVIOTA



Champagne

P306 (0.80 m)
P307 (1.00 m)
P308 (1.20 m)

CRISTALEN

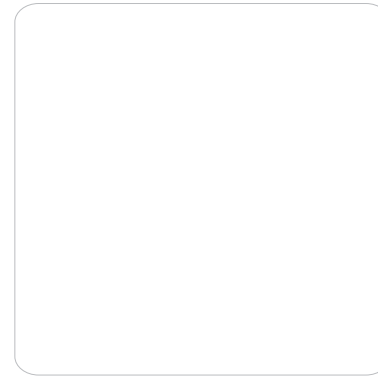

Cristal

P1 (0.70 m)
P3 (1.00 m)
P4 (1.20 m)

DECORLEN

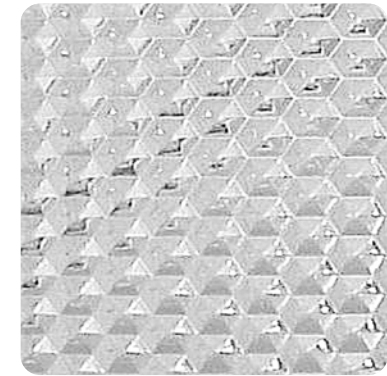

Cristal

P196 (1.20 m)

ACRÍLICOS

ACRÍLICO: CRISTAL

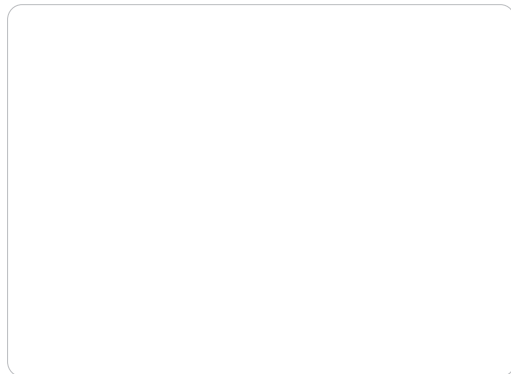

A99 0.81 x 1.83 m. **3 mm** ALTO IMPACTO
A1 0.93 x 1.83 m. **3 mm** ALTO IMPACTO
A4 1.22 x 1.83 m. **3 mm** ALTO IMPACTO
A36 1.83 x 1.83 m. **3 mm** ALTO IMPACTO
A48 2.44 x 1.83 m. **3 mm** ALTO IMPACTO

A33 1.22 x 1.83 m. **6 mm** Comercial
A90 1.22 x 1.83 m. **9 mm** Comercial
A39 2.44 x 1.22 m. **3 mm** Comercial
A86 2.44 x 1.22 m. **6 mm** Comercial
A69 2.44 x 1.83 m. **6 mm** Comercial
A105 2.44 x 1.83 m. **9 mm** Comercial

ACRÍLICO: Z-01 BLANCO

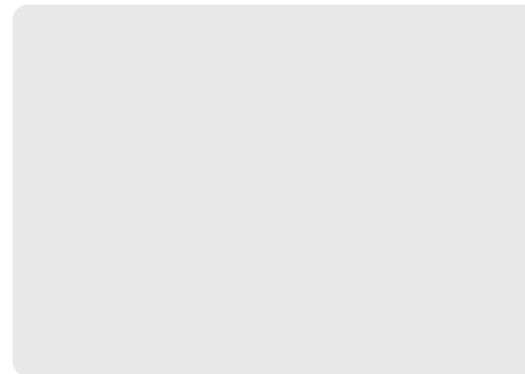

A88 0.81 x 1.83 m. **3 mm** ALTO IMPACTO
A2 0.93 x 1.83 m. **3 mm** ALTO IMPACTO
A5 1.22 x 1.83 m. **3 mm** ALTO IMPACTO
A37 1.83 x 1.83 m. **3 mm** ALTO IMPACTO
A49 2.44 x 1.83 m. **3 mm** ALTO IMPACTO

A40 2.44 x 1.22 m. **3 mm** Comercial
A34 1.22 x 1.83 m. **6 mm** Comercial
A70 2.44 x 1.83 m. **6 mm** Comercial



ACRÍLICO: PERLESCENTE

MARFIL L-401



A21 1.22 x 1.83 m. **3 mm**

BLANCO L-400

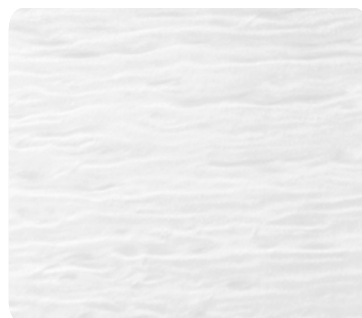

A20 1.22 x 1.83 m. **3 mm**

CAFÉ L-404



A24 1.22 x 1.83 m. **3 mm**

REJILLA PLÁSTICA

Medida: 0.61 X 1.22 m.

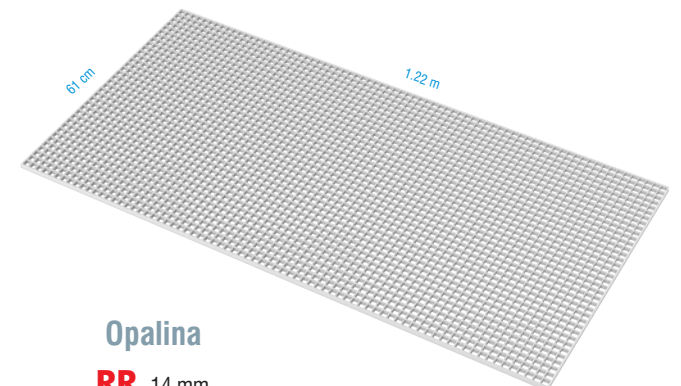

Opalina

RR 14 mm.

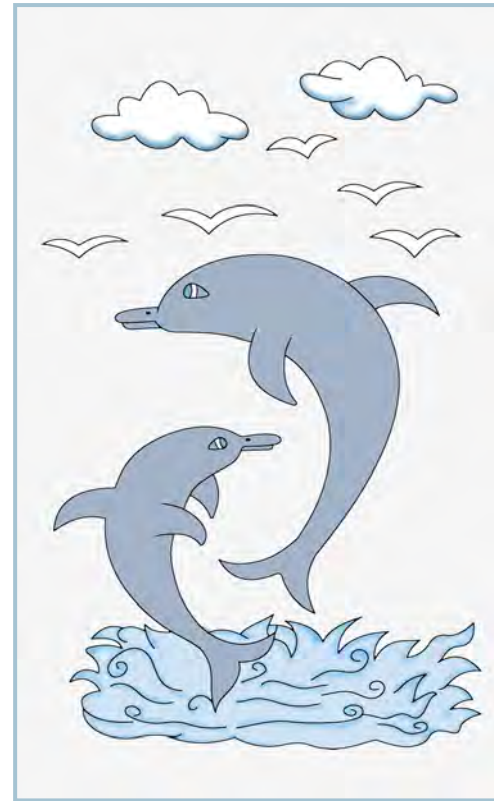

DELFINES II AD49 Acrílico 0.93 m. x 1.83 m.
Figura: 0.70 x 1.20 m. ADC49 Acrílico 0.81 m. x 1.83 m.

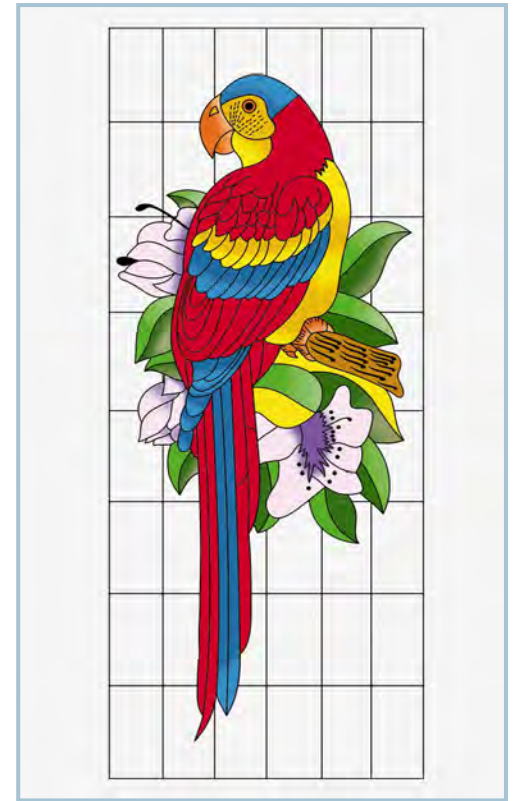

GUACAMAYA AD31 Acrílico 0.93 m. x 1.83 m.
Figura: 0.72 x 1.72 m. ADC31 Acrílico 0.81 m. x 1.83 m.

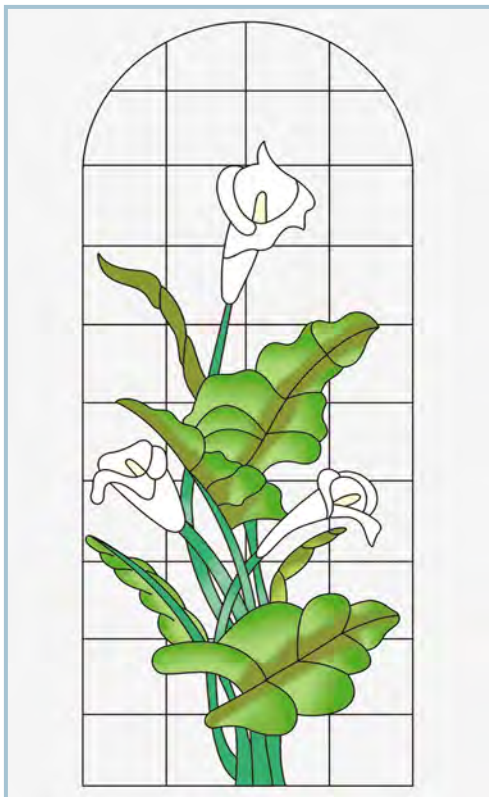

ALCATRAZ AD9 Acrílico 0.93 m. x 1.83 m.
Figura: 0.66 x 1.56 m. ADC9 Acrílico 0.81 m. x 1.83 m.

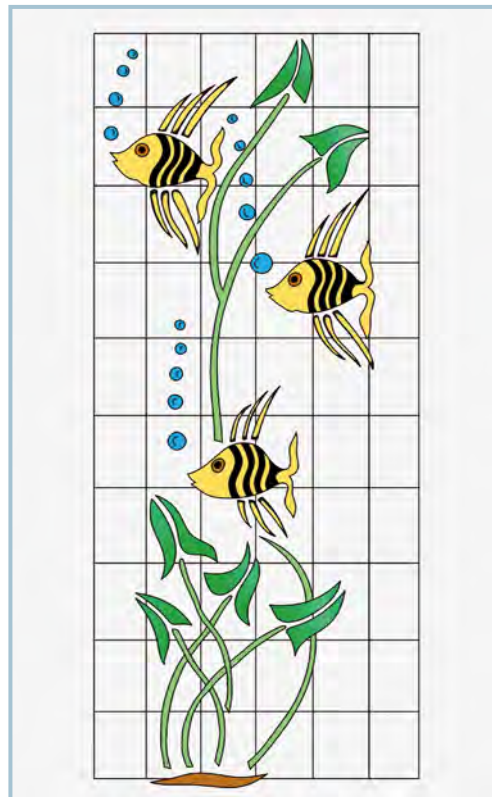

PECES AD20 Acrílico 0.93 m. x 1.83 m.
Figura: 0.60 x 1.50 m.

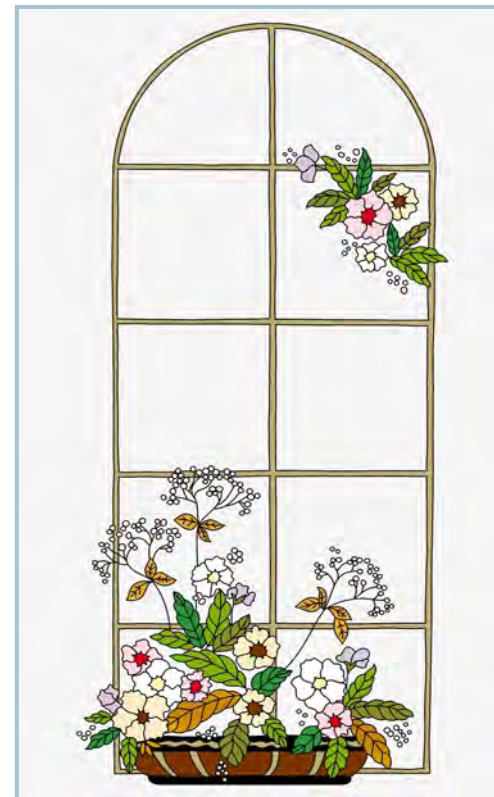

STAMBUL ADC33 Acrílico 0.81 m. x 1.83 m.
Figura: 0.68 x 1.50 m.



CISNE I AD28 Acrílico 0.93 m. x 1.83 m.
Figura: 0.65 x 1.52 m. ADC28 Acrílico 0.81 m. x 1.83 m.



SIRENITA I AD14 Acrílico 0.93 m. x 1.83 m.
Figura: 0.60 x 1.55 m. ADC14 Acrílico 0.81 m. x 1.83 m.



CISNE ADC4 Acrílico 0.81 m. x 1.83 m.
Figura: 0.66 x 1.17 m.



DAMA EN LA FUENTE AD7 Acrílico 0.93 m. x 1.83 m.
ADC7 Acrílico 0.81 m. x 1.83 m.
Figura: 0.67 x 1.15 m.



SIRENITA II AD29 Acrílico 0.93 m. x 1.83 m.
Figura: 0.73 x 1.43 m. ADC29 Acrílico 0.81 m. x 1.83 m.

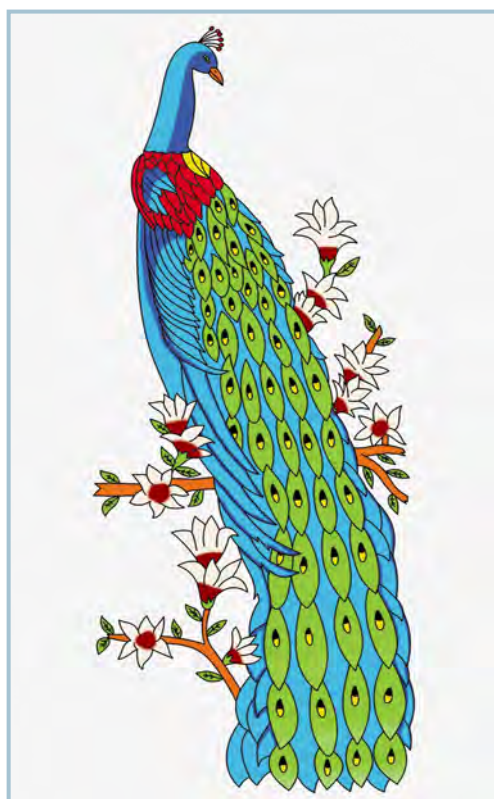

PAVO REAL ADC26 Acrílico 0.81 m. x 1.83 m.
Figura: 0.60 x 1.55 m.



DELFIN AD15 Acrílico 0.93 m. x 1.83 m.
Figura: 0.56 x 1.30 m. ADC15 Acrílico 0.81 m. x 1.83 m.



JAPONESA ADC11 Acrílico 0.81 m. x 1.83 m.
Figura: 0.61 x 1.42 m.



GRIEGA ADC2 Acrílico 0.81 m. x 1.83 m.
Figura: 0.74 x 1.18 m.

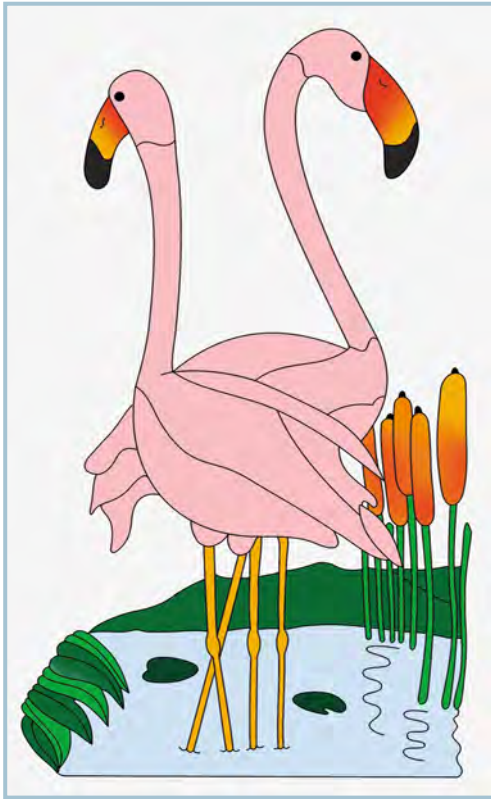

FLAMINGOS II AD17 Acrílico 0.93 m. x 1.83 m.
Figura: 0.58 x 1.05 m. ADC17 Acrílico 0.81 m. x 1.83 m.



BARCO PDC35 Plástico 0.70 m. x 1.80 m.
Figura: 0.70 x 1.10 m.

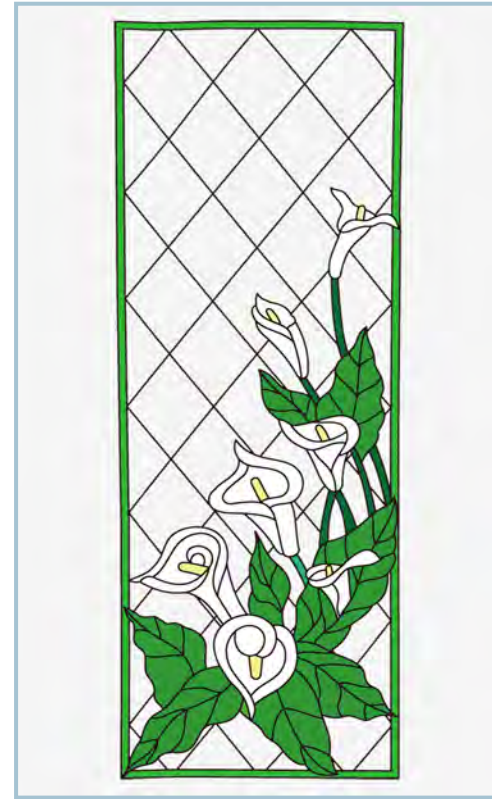

RAMILLETE DE ALCATRAZ AD50 Acrílico 0.93 m. x 1.83 m.
ADC50 Acrílico 0.81 m. x 1.83 m.
Figura: 0.56 x 1.57 m.



CEREZO PDC22 Plástico 0.70 m. x 1.80 m.
Figura: 0.60 x 1.33 m.

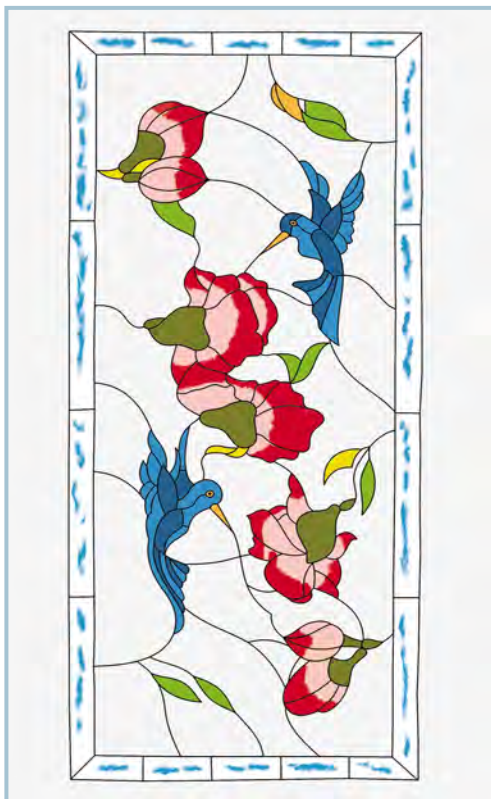

COLIBRÍ II ADC13 Acrílico 0.81 m. x 1.83 m.
Figura: 0.67 x 1.51 m.

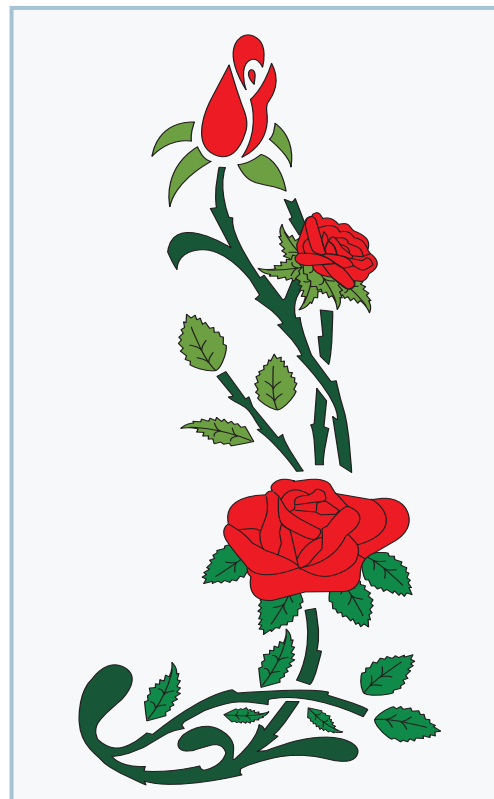

ROSAL AD55 Acrílico 0.93 m. x 1.83 m.
Figura: 0.65 x 1.43 m.

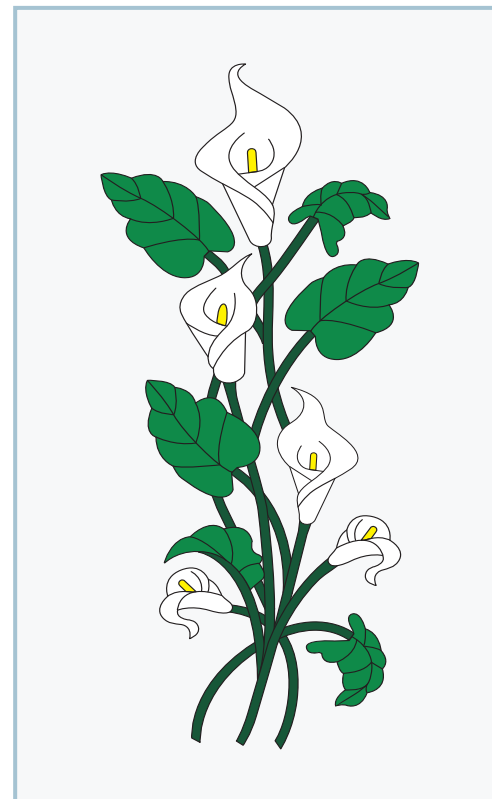

ALCATRAZ 2 AD56 Acrílico 0.93 m. x 1.83 m.
Figura: 0.59 x 1.30 m.

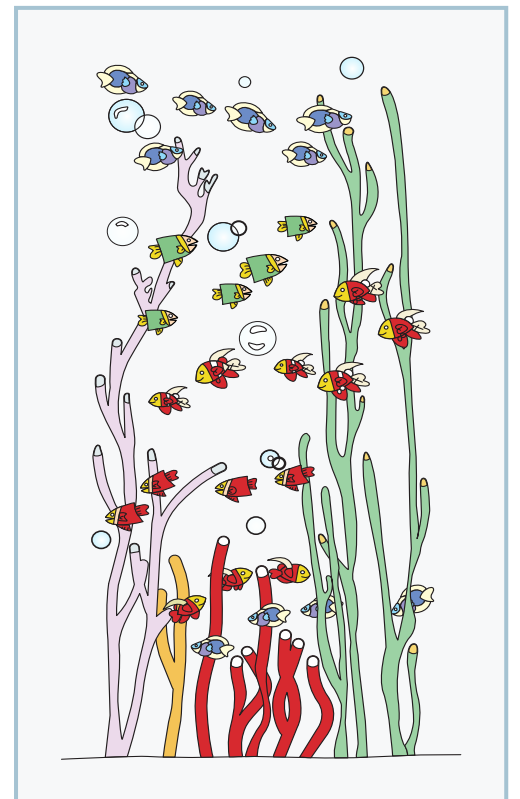

TROPICAL 2 AD54 Acrílico 0.93 m. x 1.83 m.
Figura: 0.63 x 1.33 m.

SUBLIMADOS MADERA

LOS COLORES MOSTRADOS PUEDEN VARIAR LIGERAMENTE DEL COLOR ORIGINAL



Pino Ponderosa

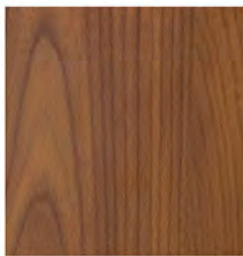

Cachimbo



Bari



Pino Oscuro Nudoso

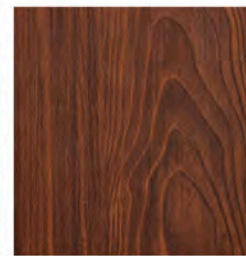

Macore 3D

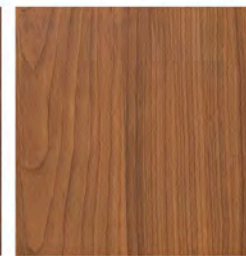

Eucalipto



Marmol Texturizado

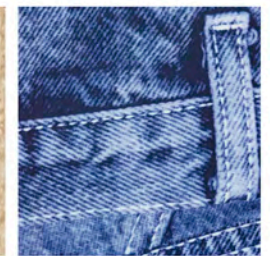

Mezclilla



Pino sin Nudo



Maple

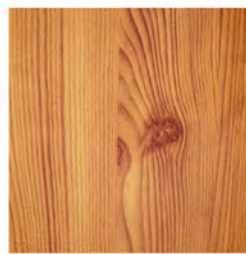

Pino Nudoso Claro



Encino

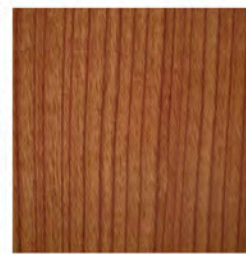

Olmo

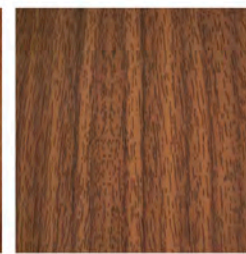

Teka

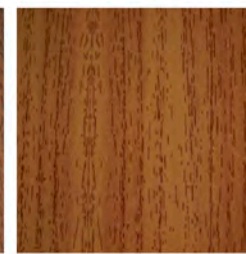

Macore



Roble

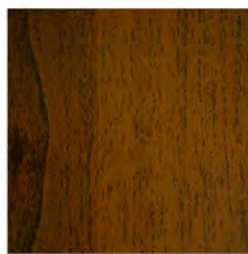

Nogal Americano

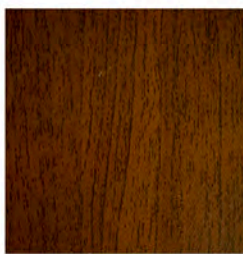

Nogal

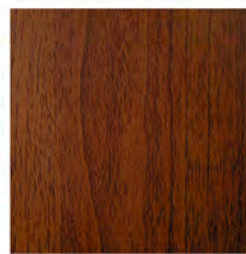

Caoba

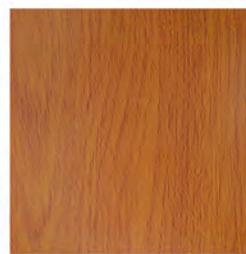

Haya

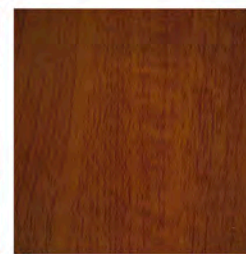

Andiroba

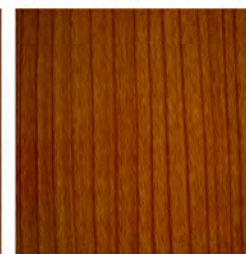

Olmo Rojo

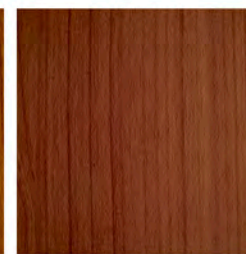

Cerezo

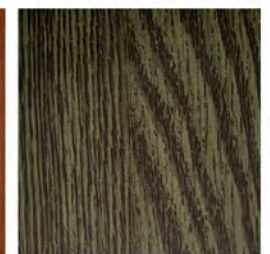

Roble Verde

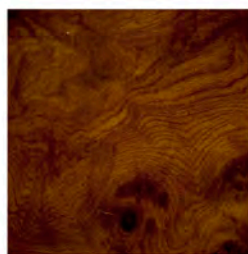

Raíz de Olmo

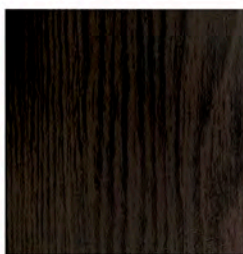

Wenge

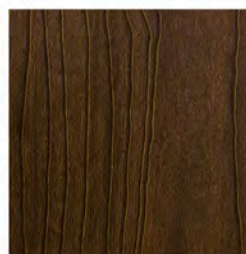

Tzalam



Olmo Blanco



Pino Dorado



Fresno Blanco

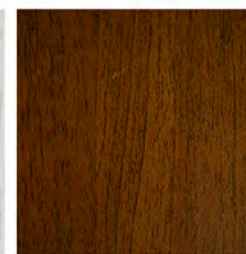

Nogal Texturizado

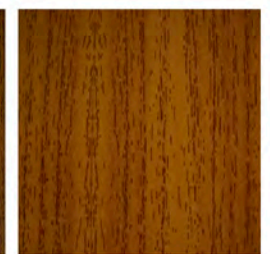

Teka Texturizado

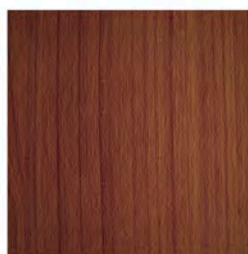

Cerezo Texturizado

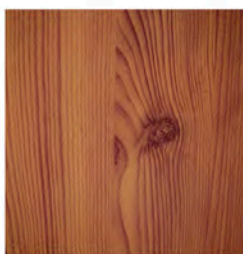

Cedro Nudoso Texturizado

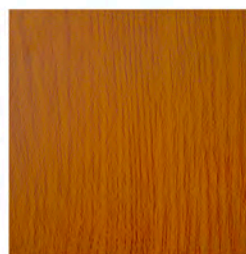

Haya Texturizado

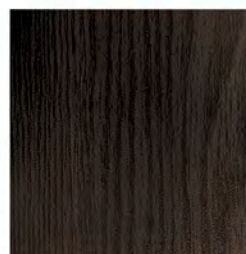

Wenge Texturizado

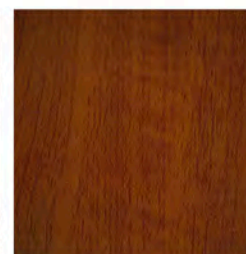

Andiroba Texturizado

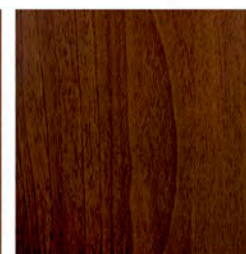

Nogal Americano Texturizado

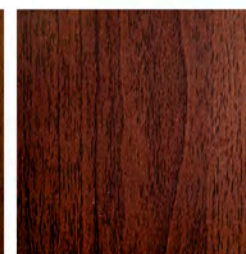

Caoba Texturizado

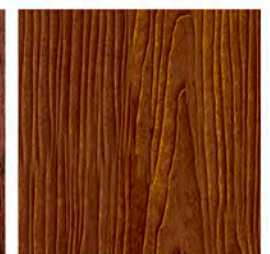

Pino Rojo Texturizado

CATÁLOGO



Perfiletto®

INNOVATION ALUMINUM

www.perfiletto.com